



TOOLS FOR
LIGHT ASSEMBLY
IN THE MEDICAL
INDUSTRY





For more than 50 years, AIMCO has been working with manufacturers around the world. We are the complete global source for all critical fastening and bolting solutions. AIMCO can effectively and swiftly meet your needs whether you're in Tennessee, USA fastening a 3 mm nut at 3 Nm, or in Denmark servicing wind-turbine bolts at 17,000 Nm. AIMCO provides the tools and solutions, on a global scale, that guarantee the success of your project. It is with great pride that AIMCO can say the products that we manufacture are **MADE IN THE USA.**

TABLE OF CONTENTS

POWER TOOLS

US-LT Pneumatic Screwdrivers	3
Electra® Series Electric Screwdrivers	6
Signature Series® Shut-Off Impact Cordless Tools	9
Signature Series® Precision Clutch Cordless Tools	10

TORQUE MEASUREMENT

APTW Preset Torque Wrenches	12
Torque Measurement Testers	13
Rundown Fixtures	15

ASSEMBLY SYSTEMS

A-50 Screw Presenters	16
Acra-Feed® Automatic Screw Feed Systems	17

TOOL SUPPORT SYSTEMS

Balancers / Retractors	18
Ergo Arms®	20
Linear Arms	22
Jib Arms	23
Workstation Components And Assemblies	24
Air Preparation Units	26
Air Line & Accessories	27



US-LT Pneumatic Screwdrivers

TORQUE CONTROL AUTOMATIC SHUT-OFF TYPE

- Precise repeatability improves quality
- Minimal wear on internal parts for longer life
- Quick shut off for minimum torque reaction
- Speed choice for flexibility
- Easy external torque adjustment
- Midrange air motor provides high speed during entire cycle
- Ideal for industrial torque control applications



US-LT30B Series



US-LT50B Series



US-LT10B



US-LT20B Series



US-LT40B Series

US-LT Light Touch Series Inline Push-To-Start Screwdrivers

Recommended Air Pressure: 85 psi

Model	Torque Range		Free Speed RPM	Overall Length		Weight		From Center To Outside		Noise Level dB(A)	Air Usage CFM
	NM	IN-LB		MM	IN	LB	KG	MM	IN		
US-LT10B	0.2 - 0.6	1.8 - 5.3	1,000	191	7.5	0.6	0.3	12.0	0.5	75	5.2
US-LT20B-10	0.4 - 1.1	3.1 - 9.7	1,000	180	7.1	0.7	0.3	13.0	0.5	70	5.6
US-LT20B-18	0.3 - 0.7	2.2 - 6.2	1,800	180	7.1	0.7	0.3	13.0	0.5	70	5.6
US-LT30B-11	1.1 - 2.1	9.7 - 18.5	1,100	187	7.4	0.9	0.4	15.5	0.6	70	7.0
US-LT30B-17	0.7 - 1.5	6.2 - 13.2	1,700	187	7.4	0.9	0.4	15.5	0.6	70	7.0
US-LT30B-23	0.4 - 1.0	3.5 - 8.8	2,300	187	7.4	0.9	0.4	15.5	0.6	71	7.0
US-LT40B-08	1.6 - 4.0	14.1 - 35.2	800	209	8.2	1.4	0.7	16.5	0.6	70	10.5
US-LT40B-15	1.0 - 2.2	6.2 - 19.4	1,500	209	8.2	1.4	0.7	16.5	0.6	70	10.5
US-LT40B-21	1.0 - 1.7	6.2 - 15.0	2,100	209	8.2	1.4	0.7	16.5	0.6	74	10.5
US-LT50B-05	5.0 - 10.2	44.0 - 92.4	480	240	9.5	2.2	1.0	19.5	0.8	74	17.5
US-LT50B-08	3.0 - 5.5	26.4 - 48.4	800	240	9.5	2.2	1.0	19.5	0.8	75	17.5
US-LT50B-17	1.5 - 2.6	9.7 - 23.0	1,700	240	9.5	2.2	1.0	19.5	0.8	75	17.5

Air Hose Size: 1/4 I.D. for US-LT10B - US-LT40B Series - 3/8" I.D. for US-LT50B Series
Each model is equipped with its standard and alternate clutch springs

Air Inlet: 1/8 for US-LT10B - US-LT20B Series - 1/4" for US-LT30B - US-LT50B Series

External Torque Adjustment (Air Shut-Off)

Set the hand driver into the key hole on the Adjusting Gear, turn clockwise to increase torque. Turn counter clockwise to decrease torque.

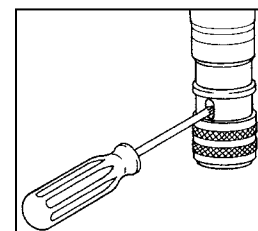

US-LT Pneumatic Screwdrivers



US-LT30B_C Series



US-LT40B_C Series



US-LT40_C Series



US-LT30BL Series



US-LT40BL Series

US-LT Light Touch Series Angle and Lever Push-To-Start Screwdrivers

Recommended Air Pressure: 85 psi

Model	Torque Range Soft Joint		Free Speed RPM	Overall Length		Weight		From Center to Outside		Hex Bit Or Drive Size IN	Noise Level dB(A)	Air Usage CFM
	NM	IN-LB		MM	IN	LB	KG	MM	IN			
Angle												
US-LT30B-11C	1.1 - 2.1	3.5 - 18.5	1,100	298	10.7	1.5	0.7	36	1.4	1/4	73	7.0
US-LT30B-17C	0.7 - 1.5	3.5 - 13.2	1,700	295	10.7	1.5	0.7	36	1.4	1/4	73	7.0
US-LT40B-03C	5.0 - 10.0	44 - 88	300	359	14.2	2.4	1.1	35.5	1.4	3/4	72	10.5
US-LT40B-05C	2.3 - 5.7	20.0 - 49.5	500	322	13.0	2.1	0.9	38.5	1.5	1/4	75	10.5
US-LT40B-08C	1.6 - 4.0	8.7 - 34.7	800	320	12.8	2.0	0.9	36	1.4	1/4	75	10.5
US-LT40B-15C	1.0 - 2.2	8.7 - 19.4	1,500	320	12.8	2.0	0.9	36	1.4	1/4	75	10.5
US-LT40-03C	5.0 - 10.0	43.4 - 86.8	300	360	14.2	2.4	1.1	35.5	1.4	1/4 Sq.	72	10.5
US-LT40-05C	2.3 - 5.7	20.0 - 50.2	500	322	13.0	2.1	0.9	35.5	1.4	1/4 Sq.	75	10.5
US-LT40-08C	1.6 - 4.0	8.7 - 34.7	800	320	12.8	2.0	0.9	32	1.3	1/4 Sq.	75	10.5
Lever												
US-LT30BL-11	1.1 - 2.1	9.7 - 18.5	1,100	229	8.2	1.2	0.5	15	0.6	1/4	70	5.2
US-LT30BL-17	0.7 - 1.5	6.2 - 13.2	1,700	229	8.2	1.2	0.5	15	0.6	1/4	70	5.2
US-LT40BL-08	1.6 - 4.0	14.1 - 35.2	800	249	9.8	1.5	0.7	17	0.7	1/4	70	5.6
US-LT40BL-15	1.0 - 2.2	8.8 - 19.4	1,500	249	9.8	1.5	0.7	17	0.7	1/4	70	5.6

Angle Head Height: 32 - 36 mm

Air Inlet: N.P.T. 1/4"

Air Hose Size: 1/4" I.D. for all models



US-LT31PB Series



US-LT41PB Series



US-LT51PB Series



US-LT60P Series

US-LT Light Touch Series Pistol Push-To-Start Screwdrivers

Recommended Air Pressure: 85 psi

Model	Torque Range (Soft Joint)		Free Speed RPM	Overall Length		Weight		From Center to Outside		Noise Level dB(A)	Air Usage CFM
	NM	IN-LB		MM	IN	LB	KG	MM	IN		
US-LT31PB-05	2.4 - 5.0	21.1 - 44.0	500	189	8.2	1.9	0.9	16	0.6	70	7.0
US-LT31PB-11	1.1 - 2.1	9.7 - 18.5	1,100	170	7.0	1.6	0.7	16	0.6	70	7.0
US-LT31PB-17	0.7 - 1.5	6.2 - 13.2	1,700	170	7.0	1.6	0.7	16	0.6	70	7.0
US-LT31PB-23	0.4 - 1.0	3.5 - 8.8	2,300	170	7.0	1.6	0.7	16	0.6	70	7.0
US-LT41PB-08	1.6 - 4.0	14.0 - 35.2	800	175	7.7	1.9	0.9	17	0.6	70	10.5
US-LT41PB-15	1.0 - 2.2	8.8 - 19.4	1,500	175	7.7	1.9	0.9	17	0.6	70	10.5
US-LT41PB-21	1.0 - 1.7	8.8 - 15.0	2,500	175	7.7	1.9	0.9	17	0.6	74	10.5
US-LT51PB-05	5.0 - 10.5	44.0 - 92.4	480	198	8.5	2.6	1.2	20	0.8	74	17.5
US-LT51PB-08	3.0 - 5.5	26.4 - 48.4	800	198	8.5	2.6	1.2	20	0.8	75	17.5
US-LT51PB-17	1.5 - 2.6	13.2 - 22.9	1,700	198	8.5	2.6	1.2	20	0.8	75	17.5
US-LT60P-03*	7.0 - 20.0	61.6 - 176.0	320	230	9.1	3.7	1.7	22	0.9	75	21.0
US-LT60P-07*	4.0 - 10.0	35.2 - 88.0	650	230	9.1	3.7	1.7	22	0.9	76	21.0
US-LT60P-11*	4.0 - 7.0	35.2 - 61.6	1,100	230	9.1	3.7	1.7	22	0.9	77	21.0

Air Hose Size: 1/4 I.D. for US-LT31PB & US-LT41PB Series

Air Inlet: N.P.T. 1/4"

3/8 I.D. for US-LT31PB-05, US-LT51PB Series & US-LT60P Series

* Optional 3/8" Sq. Drive available for US-LT60P Series ADD (P) to Model Number



US-LT Pneumatic Screwdriver Accessories



US-LT Screwdriver Optional Clutch Springs

Model	Clutch Springs Provided		Recommended Torque Range		Clutch Spring Code Number
	Standard	Option	Hard Joint		
			Nm	in-lb	
US-LT10B	Black		0.20 - 0.60	1.7 - 5.2	976-379-0
US-LT20B-10	Black		0.34 - 1.10	3.0 - 9.5	976-432-0
		Red	0.20 - 0.70	1.7 - 6.1	976-431-0
		Yellow	0.15 - 0.34	1.3 - 3.0	976-430-0
US-LT20B-18	Red		0.24 - 0.67	2.2 - 6.1	976-431-0
		Yellow	0.15 - 0.34	1.3 - 3.0	976-430-0
US-LT20B-26	Yellow		0.15 - 0.34	1.3 - 3.0	976-430-0
US-LT31PB-05	Red		2.35 - 5.00	20.9 - 44.0	976-493-0
		Pink	0.98 - 2.74	8.7 - 24.3	976-471-0
US-LT30 Series, 1,100 rpm	Blue		0.98 - 2.1	8.7 - 18.5	976-472-0
		Red	0.67 - 1.76	6.1 - 15.6	976-493-0
		Pink	0.39 - 0.98	3.5 - 8.7	976-471-0
		Black (not included)	1.22 - 2.74	10.8 - 24.3	976-504-0
US-LT30 Series, 1,700 rpm	Red		0.67 - 1.47	6.1 - 13.0	976-493-0
		Pink	0.39 - 0.98	3.5 - 8.7	976-471-0
US-LT30 Series, 2,300 rpm	Pink		0.39 - 0.98	3.5 - 8.7	976-471-0
US-LT40-03C	Red		4.90 - 9.80	43.4 - 86.8	976-516-0
US-LT40 Series, 800 rpm	Black		1.57 - 3.92	13.9 - 34.7	976-515-0
		Red	0.98 - 2.17	8.7 - 19.1	976-516-0
		Yellow	0.98 - 1.67	8.7 - 14.8	976-517-0
US-LT40 Series, 1,500 rpm	Red		0.98 - 2.17	8.7 - 19.1	976-516-0
		Yellow	0.98 - 1.67	8.7 - 14.8	976-517-0
US-LT40 Series, 2,100 rpm	Yellow		0.98 - 1.67	8.7 - 14.8	976-517-0
US-LT50 Series, 500 rpm	Black		4.9 - 10.3	43.4 - 91.1	976-620-0
		Red	2.9 - 5.4	26.1 - 47.7	976-614-0
		Yellow	1.4 - 2.5	13.0 - 22.6	976-588-0
US-LT50 Series, 800 rpm	Red		2.7 - 5.4	24.3 - 47.7	976-614-0
US-LT50 Series, 1,700 rpm	Yellow		1.4 - 2.5	13.0 - 22.6	976-588-0
		Yellow	1.4 - 2.6	13.0 - 23.0	976-588-0

Electric Screwdrivers



- Available in push-to-start and lever start styles
- Ergonomic design – Lightweight, compact housings ensure operator comfort during operation
- Accurate torque control – Precise controlled fastening with automatic shut-off clutches
- External brush replacement – Virtually no down time for brush replacement
- External torque adjustment – Torque level can be easily adjusted by simply turning the external adjustment ring



AE-5681



- UL Listed and CE Certified – Drivers meet electrical safety standards in both the U.S. and Europe
- Direct plug-in style – Offers easy and convenient start-up (certain models), simply plug it in
- State-of-the-art motor design – Ensures comfortable grip temperature for operator and extended motor life

Electra® Series Screwdrivers

Model	Torque Range		Free Speed RPM	Weight		Length		Hex Drive		Power Source
	IN-LB	KGF-CM		LB	KG	IN	MM	IN	MM	
Push-To-Start Direct Plug-In Series										
AE-5681 (Includes torque cover)	3.5 - 15.6	4 - 18.0	1,000	1.2	0.5	9.3	237	1/4	6.4	115V AC*
AE-8681 (Includes pistol grip handle adapter)	15 - 45	23.0 - 51.8	600	1.6	0.7	10.6	269	1/4	6.4	115V AC*
Low-Voltage Lever Start Series (Requires External Power Supply)										POWER SUPPLY:
AE-2020	.35 - 1.3	.40 - 1.5	720	0.7	0.3	8.0	203	1/4	6.4	See page 130 for required power supplies
AE-4020	.9 - 5	1.0 - 6.0	720	0.7	0.3	8.0	203	1/4	6.4	
AE-4520	1.3 - 8.7	1.5 - 10.0	720	0.7	0.3	8.0	203	1/4	6.4	
AE-7010	6.1 - 17.4	7.0 - 20.0	750	1.4	0.6	9.3	236	1/4	6.4	
AE-8010	10.4 - 26.0	12.0 - 29.9	550	1.4	0.6	9.3	236	1/4	6.4	
Low-Voltage Push-To-Start Series (Requires External Power Supply)										
AE-7010PS	6.1 - 17.4	7.0 - 20.0	750	1.4	0.6	9.3	236	1/4	6.4	
AE-8010PS	10.4 - 26.0	12.0 - 29.9	550	1.4	0.6	9.3	236	1/4	6.4	

* 220V AC is available upon request. Contact AIMCO at 1-503-254-6600, or toll free 1-800-852-1368.

ELECTRA® LOW ESD SERIES

- Grounded bit – Grounded chuck assembly routes any existing charge to ground
- Carbonized housing – Handle material and buttons are constructed of carbonized plastic throughout, enabling any charge received by the handle to be routed to ground
- Long-Lasting ESD resistant handle – Material will maintain its integrity for the life of the handle, unlike coatings or paints



AE-5681ESD



Electra® Low ESD Series Screwdrivers

Model	Torque Range		Free Speed RPM	Weight		Length		Hex Drive		Power Source
	IN-LB	KGF-CM		LB	KG	IN	MM	IN	MM	
AE-4520ESD*	1.3 - 8.7	1.5 - 10.0	720	0.9	0.4	8.0	204	1/4	6.4	35V DC
AE-5681ESD	3.5 - 15.6	4 - 18.0	1,000	1.2	0.5	9.3	237	1/4	6.4	115V AC**

* Low-voltage units require an external power supply.

** 220V AC is available upon request. Contact AIMCO at 1-503-254-6600, or toll free 1-800-852-1368.



Electric Screwdrivers

ELECTRA® SLIP CLUTCH SERIES

- High-speed performance – For quick and consistent assembly and disassembly
- Maximum ergonomics and convenience – Offers a combination of a slip clutch with a high speed motor to provide low torque reaction; one of the best power-to-weight ratios in the industry
- Added maintenance feature – LED light indicates when to change brushes. Brush cap contains a switch that shuts off the power during brush replacement
- Direct 110V plug-in – Eliminates the need for an external power supply



AE-2015



- 1/4" hex quick change chuck for easy bit changes
- External torque collar for easy torque adjustment.

Electra® Slip Clutch Series Screwdrivers

Model	Recommended Torque Range		Free Speed RPM	Weight		Length		Hex Drive		Power Source
	IN-LB	KGF-CM		LB	KG	IN	MM	IN	MM	
AE-2015	4.3 - 21.7	5.0 - 25.0	1,000	1.2	.55	9.2	234	1/4	6.4	110 V / 120V AC*

** 220V AC is available upon request. Contact AIMCO at 1-503-254-6600, or toll free 1-800-852-1368.

PRECISION SERIES

- For low torque applications
- Featuring ergonomic design
- Comes with options such as long-life brushless motors and adjustable speed power supplies



AE-6300
AE-6450



STANDARD MODELS

- Optional speed control power supply – Enables infinite control from 20% to 100% of maximum tool speed and adjustable soft start to minimize cross threading
- Ergonomic housing – Oval shape conforms to hand
- Duralite – Casing material provides a secure grip
- Feather touch integrated lever reduces travel and stress. Requires only 2 mm of travel to activate
- External torque control – Twist and go

EXTENDED LIFE MODELS

- Sealed Swiss motor – For higher duty cycles, longer life, and less maintenance. Sealed casing means no brush changes are necessary
- Extended warranty on tool motor – Three year standard motor warranty
- Compact power supply – Makes setup a breeze

Electra® Precision Series Screwdrivers

Model	Torque Range		Free Speed RPM	Weight		Length		Hex Drive IN
	IN-LB	KGF-CM		LB	KG	IN	MM	
Standard								
AE-6300	.85 - 5.0	1.0 - 5.8	725	0.9	0.4	8.5	216	1/4
AE-6450	1.3 - 8.7	1.5 - 10.0	770	0.9	0.4	8.5	216	1/4
High Speed								
AE-6300S	.35 - 4.3	0.4 - 5.0	920	0.9	0.4	8.5	216	1/4
AE-6450S	1.3 - 8.7	1.5 - 10.0	920	0.9	0.4	8.5	216	1/4
Extended Life								
AE-6300M	1.0 - 5.5	1.1 - 6.3	550	0.9	0.4	8.5	216	1/4

Electric Screwdrivers



AE-224PS
AE-278PS

APM-30

Electra® Series Power Supplies

Model	Compatible Screwdrivers	Tool RPM	Voltage Conversion	Dimensions	Weight LB KG
AE-224PS	AE-2020 AE-2020ESD AE-4020 AE-4520 AE-4520ESD	720	110V AC - 220V AC 35V DC	2.6 x 1.6 x 5.0 66 x 41 x 127 mm	1.0 .45
AE-278PS	AE-7010 AE-7010PS	STANDARD	110V AC - 220V AC 30V DC	1.6 x 5.0 x 2.6 41 x 127 x 66 mm	1.0 .45
APM-30	AE-6300M	550	110V AC - 220V AC 30V DC	2.1 x 3.4 x 1.9 53 x 87 x 48 mm	0.4 0.2



DIGITAL FASTENING COUNTER

The AM Series fastener counter verifies and error-proofs the assembly process.

- Buzzer notifies of missing screws, incomplete fastening, and thread damage
- Counts up to 60,000 units and up to 99 screws per unit
- Connects easily to automation equipment using standard input/output signals
- Large LCD screen is easy to read. A green screen indicates OK fastening, a red screen indicates NG

Digital Fastening counters for Electra® Series Screwdrivers

Model	Compatible Screwdrivers
AM-45	For AE-2020, AE-4020, AE-4520 Standard and ESD types
AM-65	For AE-7010, AE-7010PS, AE-8010 and AE-8010PS

OPTIONAL ACCESSORIES



Angle Head Attachments

Available for lever start series.
Not available for Low ESD Series.



Pistol Grip Handle

Converts to a pistol style driver for horizontal fastening. Available for Trigger Start only (included with AE-8681).



Torque Cover

Prevents accidental torque adjustment by the operator (included with AE-5681).

Electra® Series Screwdriver Accessories

Item	Model	Compatible Screwdrivers
Angle Head Attachments	AE-2045A	For AE-2020, AE-4020, AE-4520
	AE-7080A	For AE-7010, AE-8010
Pistol Grip Handle	AE-PG7080	For AE-7010, AE-7010PS, AE-8010, AE-8010PS
Torque Cover	AE-TC2040	For AE-2020, AE-4020, AE-4520
	AE-TC7080	For AE-7010, AE-7010PS, AE-8010, AE-8010PS
	4H2055	For AE-8681



Tested and PROVEN to BEAT the competition in vibration and noise levels

These tools outperform the competition in number of rundowns per battery charge



SHUT-OFF IMPACT TOOLS

The Signature Series Impact Shut-Off Pistol Tool can operate as a standard impact wrench or as an impact wrench with a programmable shut-off point, preventing over-torquing. These innovative tools deliver a torque range of 3 - 120 Nm (2 - 89 ft-lb). No torque reaction, coupled with the ergonomic, lightweight design and reduced vibration, helps to prevent user injury.

FEATURES AND BENEFITS

- Brushless motor provides longer motor life and increased efficiency
- Easy-to-read process information lights
- Advanced shut-off system
- LED light for work-area illumination
- Programmable buttons for easy operation
- Li-Ion battery provides long battery life
- Mini USB port for connection to optional programmer (SPC-2PGM)



SIW Signature Series Cordless Impact Tools

Model	Torque Range		Max Torque		Free Speed	Battery (V)	Weight		Anvil Size	Noise Level dB(A)
	NM	FT-LB	NM	FT-LB			LB	KG		
SIW-P2525Q	3 - 25	2 - 18	40	30	2,400	20	2.2	1	1/4 QC	71
SIW-P3225Q	6 - 32	4 - 24	90	66	2,400	20	2.2	1	1/4 QC	71
SIW-P3238	6 - 32	4 - 24	90	66	2,400	20	2.2	1	3/8 Sq Dr	71
SIW-P5538	15 - 55	11 - 41	120	90	2,400	20	2.4	1.1	3/8 Sq Dr	71
SIW-P5550	15 - 55	11 - 41	120	90	2,400	20	2.4	1.1	1/2 Sq Dr	71
SIW-P10050	25 - 100	18 - 74	180	133	2,400	20	2.4	1.1	1/2 Sq Dr	71
SIW-P12050	30 - 120	22 - 89	210	155	2,400	20	2.9	1.3	1/2 Sq Dr	71

Shut-Off Impact Tools Include: Body Jacket, Bail, and one (1) 18V Li-Ion Battery

BATTERY AND CHARGER

The Signature Series Shut-Off Impact Tool battery features a slim profile design and a slide mount connection to the tool, which ensures durability and makes changing out batteries quick and easy.

Battery Model #	Voltage / Capacity	Type
SIW-B20LI	20V, 2.0 Ah	Li-Ion
SIW-B20LI-HC	20V, 4.0 Ah	Li-Ion
Charger Model #	Output	Input
SIW-C18-20	18 - 20V, 4.0 A	100 - 240VAC, 50-60 Hz



ACCESSORIES

Model #	Description
BJ10091	Grey Body Jacket Cover
SIW-PBL	Suspension Bail
SIW-38PR	Pin Retainer Kit, 3/8" Drive
SIW-50PR	Pin Retainer Kit, 1/2" Drive



Quick shut-off, precision clutch minimizes torque reaction and ensures precise application of torque

PRECISION CLUTCH TOOLS

Signature Series precision clutch tools feature a quick-releasing clutch that delivers accuracy across multiple joint types. Constructed of precision machined parts, this tool guarantees accuracy and durability over the life of the tool.

FEATURES AND BENEFITS

- LED indicator provides simple process information to the operator. The signal is visible from any angle
- Press button for easy F/R operation
- LED light for working in dark areas
- Trigger repeat protection avoids double hits on already seated screws
- Easily attached sliding battery system
- Mini USB port for connection to optional programmer (SPC-2PGM)
- Li-Ion battery pack delivers longer run time
- Ergonomic handle design provides outstanding balance and weight and is ideal for accessing hard-to-reach locations
- Angle tool enables multiple head positions



SPC Signature Series Cordless Clutch Tools

Model	Torque Range		Free Speed RPM Range (Programmable with Programmer Accessory)	Battery Voltage	Tool Weight (w/o Battery)		Anvil Size
	NM	FT-LB			LB	KG	
Pistol*							
SPC-P23250	.8 - 3	.6 - 2.2	500 - 1,550	18V	2.1	.95	1/4" QC
SPC-P26250	1 - 6	.7 - 4.4	300 - 1,000	18V	2.1	.95	1/4" QC
SPC-P29250	1.5 - 9	1.1 - 6.6	300 - 800	18V	2.1	.95	1/4" QC
SPC-P212250	2 - 12	1.5 - 8.8	250 - 600	18V	2.1	.95	1/4" QC
Right Angle**							
SPC-A210250	3 - 12	2.2 - 8.8	400 - 1,000	18V	3.5	1.6	1/4" QC
SPC-A21025	3 - 12	2.2 - 8.8	400 - 1,000	18V	3.5	1.6	1/4" Sq
SPC-A21038	3 - 12	2.2 - 8.8	400 - 1,000	18V	3.5	1.6	3/8" Sq
SPC-A216250	5 - 18	3.7 - 13.3	300 - 600	18V	3.5	1.6	1/4" hex
SPC-A21625	5 - 18	3.7 - 13.3	300 - 600	18V	3.5	1.6	1/4" Sq
SPC-A21638	5 - 18	3.7 - 13.3	300 - 600	18V	3.5	1.6	3/8" Sq
SPC-A23038	8 - 30	5.9 - 22	250 - 480	18V	3.5	1.6	3/8" Sq
SPC-A23538	10 - 35	7.4 - 25.8	220 - 330	18V	3.5	1.6	3/8" Sq
SPC-A25038	10 - 50	7.4 - 37	200 Non-Programmable Fixed Speed***	18V	5.3	2.4	3/8" Sq
SPC-A27038	20 - 70	14.8 - 51.7	170 Non-Programmable Fixed Speed***	18V	6.3	2.9	3/8" Sq
SPC-A210050	35 - 100	26 - 74	119 Non-Programmable Fixed Speed***	18V	7.4	3.4	1/2" Sq

* Pistol Grip Tools include: Torque Adjustment Tool and one (1) 18V Li-Ion Battery

** Angle Nutrunners include: Torque Adjustment Tool, Head Indexing Spanner Wrench, and one (1) 18V Li-Ion Battery

*** High torque tools feature fixed RPM



Signature Series Precision Clutch Cordless Tool Accessories

BATTERY AND CHARGER

One universal battery and charger interface with all of the Signature Series Precision Clutch tools. Each tool utilizes the same lightweight 18V Li-Ion battery, which provides superior battery life. The charger accepts input AC power of 100 - 240VAC, making use simple anywhere in the world.

Batteries and Charger for SPC Signature Series Cordless Clutch Tools

Battery Model	Voltage	Type	Capacity	Weight
SPC-B218LI	18V	Li-Ion	2.0 Ah	.8 Lb/.4 kg
SPC-B218LI-HC	18V	Li-Ion	4.0 Ah	1.4 Lb/.64 kg

Charger Model	Output	Input	Dimensions (W/O Battery)	Weight
SPC-C218-20	18V-19.2V 3.0 A	100-240VAC 50-60 Hz	6.25" deep x 5" wide x 3.5" tall 158.75 mm x 127 mm x 89 mm	1.2 Lb/.54 kg



PRECISION CLUTCH TOOL ATTACHMENTS

A wide variety of special heads and attachments can be fitted to Signature Series Angle Nutrunners. Contact your AIMCO representative for assistance, 1-503-254-6600, or toll free 1-800-852-1368.



TOOL SPEED PROGRAMMER

Each Signature Series battery tool has programmable features that enhance operator efficiency.



Programmable features include:

- Tool speed control from minimum (1,500 rpm) to maximum (2,400 rpm) speed in 50 rpm increments
- Forward/Reverse Mode - Three setting options
- Two-stage trigger delay control
- Screw count / impact count
- Supervisor level "lock-out" control

Additionally, the Signature Series battery tool has an integrated mini USB connector that couples to the Signature Series Programmer module. Simply connect the tool to the Programmer Module and flash the tool to the desired RPM. The programmed RPM will remain until a change is desired.

QUICK CLIP

The two piece Quick Clip comes with a belt clip and a stretch cord attachment for a pistol tool. The patented ball feature allows for quick and easy release.



TOOL BASKETS

AIMCO tool baskets can be affixed to a bench or rack and can be used for either a pistol or right angle tool.

BODY JACKETS

Prevent damage to the workpiece.

Model	Description
BJ10082	Clear Body Jacket for Signature Series Precision Clutch Pistol Tools
BJ10083	Clear Body Jacket for Signature Series Precision Clutch Angle Nutrunners

Auditor Preset Torque Wrenches

Auditor's APTW preset wrenches provide a flexible, easy way to audit fastener torque. A wide range of interchangeable heads provide flexibility and convenience.

FEATURES AND BENEFITS



- Easy-to-use preset wrenches for fastener torque auditing
- Torque ranges from 5 – 340 Nm
- User friendly, sleek, ergonomic design
- Tactile feedback on achievement of preset torque
- Proprietary adjustment tool guards against unauthorized setting changes
- Wide range of interchangeable heads provide flexibility and convenience
- +/- 3% accuracy when used in clockwise or counterclockwise directions







APTW Torque Wrench Models



WRENCH MODEL	TORQUE RANGE	INSERT ACCEPTED
APTW-25	5 - 25 Nm	12 mm
APTW-50	10 - 50 Nm	12 mm
APTW-100	20 - 100 Nm	12 mm
APTW-150	30 - 150 Nm	12 mm
APTW-200	40 - 200 Nm	14 mm
APTW-340	60 - 340 Nm	14 mm

TORQUE WRENCH INSERTS

Adapters	Description
 APT-12ADP	9 x 12 M to 14 x 18 F
 APT-14ADP	14 x 18 M to 9 x 12 F

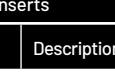
Ring End Inserts	Description
 APT-12RE50	1/2" Ring End, 12 mm
 APT-14RE32	3/2" Ring End, 14 mm

Square Drive Inserts	Description
9 x 12	
 APT-12SD25	1/4" Sq. Dr.
 APT-12SD38	3/8" Sq. Dr.
 APT-12SD50	1/2" Sq. Dr.
14 x 18	
 APT-14SD50	1/2" Sq. Dr.

Blank End Inserts	Description
 APT-12BLANK	12 mm
 APT-14BLANK	14 mm

Ratchet Heads	Description
9 x 12	
 APT-12RT25	1/4" Sq. Dr.
 APT-12RT38	3/8" Sq. Dr.
 APT-12RT50	1/2" Sq. Dr.
14 x 18	
 APT-14RT50	1/2" Sq. Dr.
 APT-14RT34	3/4" Sq. Dr.

Open End Head Inserts								
		9 x 12		14 x 18				
	Model	Description	Model	Description	Model	Description		
								
		APT-120E7	7 mm OE	APT-140E1	1" OE	APT-140E25	25 mm OE	
		APT-120E8	8 mm OE	APT-140E13	13 mm OE	APT-140E27	27 mm OE	
		APT-120E9	9 mm OE	APT-140E14	14 mm OE	APT-140E30	30 mm OE	
		APT-120E10	10 mm OE	APT-140E15	15 mm OE	APT-140E32	32 mm OE	
		APT-120E11	11 mm OE	APT-140E16	16 mm OE	APT-140E34	34 mm OE	
		APT-120E12	12 mm OE	APT-140E17	17 mm OE	APT-140E36	36 mm OE	
		APT-120E13	13 mm OE	APT-140E18	18 mm OE	APT-140E38	38 mm OE	
		APT-120E14	14 mm OE	APT-140E19	19 mm OE	APT-140E41	41 mm OE	
		APT-120E15	15 mm OE	APT-140E21	21 mm OE	APT-140E118	1-1/8" OE	
		APT-120E16	16 mm OE	APT-140E22	22 mm OE	APT-140E138	1-3/8" OE	
		APT-120E17	17 mm OE	APT-140E24	24 mm OE			
		APT-120E18	18 mm OE					
		APT-120E19	19 mm OE					
		APT-120E20	20 mm OE					
		APT-120E50	1/2" OE					



Auditor Torque Cube



ATC-10
ATC-25
ATC-100
ATC-250
ATC-500
ATC-750
ATC-1800



ATC-150F
ATC-250F
ATC-500F
ATC-750F



AUDITOR TORQUE CUBE

The Auditor Torque Cube (ATC) is a compact, versatile desktop tester that provides a multitude of capabilities. The ATC is designed to test hand or power tools with the following:

- Peak, first peak, and track modes
- Multiple engineering units
- Manual and auto clear function
- Multiple frequency response settings
- Bi-directional use and accuracy
- Accuracy is better than 1% of indicated reading top 90% of range
- Serial data output
- Memory: 999 data samples
- Battery and/or mains powered

Because precision and quality are critical, you can depend on Auditor testers to calibrate and certify your tools. Whether you are assembling large complicated systems or small precise time pieces, AIMCO provides the best system for your application. Our instruments have been judged "best in class" by independent National Standards laboratories. Auditor Torque Cube is rugged enough to test and verify tools at "point of use" while still being accurate enough to calibrate hand and power tools.

Each tester is shipped with a mains/battery charger power cord, a hex to allen drive bit, and a bolting template. Models with max torque of 1,000 in-lb or less also include a joint rundown fixture. The ATC can be positioned vertically or horizontally for the ergonomic testing of inline or pistol grip tools.

ATC Auditor Torque Cube Models

Model	Recommended Torque Range		KG	Weight		W x H x D		Square Drive IN
	NM	IN-LB/FT-LB		LB	MM	IN		
Vertical Configuration								
ATC-10	0.13 - 1.13	1 - 10 in-lb	1.13	2.5	79 x 95 x 83	3.13 x 3.75 x 3.25	1/4	
ATC-25	0.28 - 2.83	2.5 - 25 in-lb	1.13	2.5	79 x 95 x 83	3.13 x 3.75 x 3.25	1/4	
ATC-100	1.13 - 11.3	10 - 100 in-lb	1.13	2.5	79 x 95 x 83	3.13 x 3.75 x 3.25	1/4	
ATC-250	2.83 - 28.3	25 - 250 in-lb	1.13	2.5	79 x 95 x 83	3.13 x 3.75 x 3.25	3/8	
ATC-500	5.65 - 56.5	50 - 500 in-lb	1.13	2.5	79 x 95 x 83	3.13 x 3.75 x 3.25	3/8	
ATC-750	8.47 - 84.8	75 - 750 in-lb	1.13	2.5	79 x 95 x 83	3.13 x 3.75 x 3.25	3/8	
ATC-1000	11.3 - 113	100 - 1000 in-lb	1.13	2.5	79 x 95 x 83	3.13 x 3.75 x 3.25	3/8	
ATC-1800	21.2 - 203	188 - 1,800 in-lb	1.13	2.5	79 x 95 x 83	3.13 x 3.75 x 3.25	1/2	
Horizontal Configuration								
ATC-150F	20 - 200	15 - 150 ft-lb	2.25	5	79 x 95 x 83	3.13 x 3.75 x 3.25	1/2	
ATC-250F	34 - 340	25 - 250 ft-lb	2.25	5	79 x 95 x 83	3.13 x 3.75 x 3.25	1/2	
ATC-500F	68 - 678	50 - 500 ft-lb	2.25	5	79 x 95 x 83	3.13 x 3.75 x 3.25	3/4	
ATC-750F	102 - 1,017	75 - 750 ft-lb	2.25	5	79 x 95 x 83	3.13 x 3.75 x 3.25	3/4	

Auditor Bench-Mount Testers



AUET



AUET/MTM



AUET/MTM-DC

AUDITOR UNIVERSAL ELECTRONIC TESTERS

Auditor Universal Electronic Testers (AUET) have a broad range of features to accommodate most requirements. They are designed to be bench-top mounted and are available in several configurations and various single or multiple torque ranges. Onboard memory allows you to capture 999 torque event readings. The testers are also available in file capability (DC) models that require PC software Auditor Tool Manager (ATM).

Instruments up to 1,000 in-lb are supplied with rundown adapters/joint kits. Rundown kits for larger instruments can be ordered separately. AUET/MTM units are supplied with an external transducer port and selector switch for connecting additional transducers.

AUET testers utilize the same transducers as the ATC instruments, providing the same high quality accuracy and durability. The common interface makes the Auditor tester extremely user friendly.



AUET Single Transducer Models

Model*	Recommended Torque Range	
	KGF-CM/NM	IN-OZ/IN-LB
AUET-050(-DC)	0.4 - 3.6 kgf-cm	5 - 50 in-oz
AUET-0100(-DC)	0.7 - 7.2 kgf-cm	10 - 100 in-oz
AUET-10(-DC)	1.1 - 11.5 kgf-cm	1 - 10 in-lb
AUET-50(-DC)	0.5 - 5.6 Nm	5 - 50 in-lb
AUET-100(-DC)	1.1 - 11.3 Nm	10 - 100 in-lb
AUET-250(-DC)	2.8 - 28.3 Nm	25 - 250 in-lb
AUET-500(-DC)	5.7 - 56.5 Nm	50 - 500 in-lb
AUET-1000(-DC)	11.3 - 113 Nm	100 - 1,000 in-lb
AUET-1200(-DC)	13.6 - 135.6 Nm	120 - 1,200 in-lb
AUET-1800(-DC)	20.3 - 203.4 Nm	180 - 1,800 in-lb

* Add "-DC" to part numbers for data collecting models.

Data collecting models allow multiple files/tools/applications to be associated with torque data. Requires Tool Manager software.

Custom sizes are also available. Contact an AIMCO Customer Service Associate for ordering options, 1-503-254-6600, or toll free 1-800-852-1368.

AUET/MTM Dual Transducer Models

Model**	Recommended Torque Range			
	Transducer 1	Transducer 2	Transducer 1	Transducer 2
AUET/MTM-050-25	0.04 - 0.4 Nm	0.3 - 2.8 Nm	5 - 50 in-oz	2.5 - 25 in-lb
AUET/MTM-050-600	0.04 - 0.4 Nm	6.8 - 67.8 Nm	5 - 50 in-oz	60 - 600 in-lb
AUET/MTM-0100-050	0.07 - 0.71 Nm	0.04 - 0.4 Nm	10 - 100 in-oz	5 - 50 in-oz
AUET/MTM-10-100	0.11 - 1.12 Nm	1.3 - 11.3 Nm	1.0 - 10 in-lb	10 - 100 in-lb
AUET/MTM-50-250	0.56 - 5.65 Nm	2.8 - 28.3 Nm	5.0 - 50 in-lb	25 - 250 in-lb
AUET/MTM-50-500(-DC)	0.56 - 5.65 Nm	5.7 - 56.5 Nm	5.0 - 50 in-lb	50 - 500 in-lb
AUET/MTM-50-1000(-DC)	0.56 - 5.65 Nm	11.3 - 113 Nm	5.0 - 50 in-lb	100 - 1,000 in-lb
AUET/MTM-100-500	1.13 - 11.3 Nm	5.7 - 56.5 Nm	10 - 100 in-lb	50 - 500 in-lb
AUET/MTM-100-1000	1.13 - 11.3 Nm	11.3 - 113 Nm	10 - 100 in-lb	100 - 1,000 in-lb
AUET/MTM-100-1200	1.13 - 11.3 Nm	13.6 - 135.6 Nm	10 - 100 in-lb	120 - 1,200 in-lb
AUET/MTM-100-1600(-DC)	1.13 - 11.3 Nm	18.1 - 180.8 Nm	10 - 100 in-lb	160 - 1,600 in-lb
AUET/MTM-100-2000	1.13 - 11.3 Nm	22.6 - 226 Nm	10 - 100 in-lb	200 - 2,000 in-lb
AUET/MTM-250-1600	2.82 - 28.2 Nm	18.1 - 180.8 Nm	25 - 250 in-lb	160 - 1,600 in-lb
AUET/MTM-250-1800	2.82 - 28.2 Nm	20.3 - 203.4 Nm	25 - 250 in-lb	180 - 1,800 in-lb
AUET/MTM-250-2500	2.82 - 28.2 Nm	28.2 - 282.5 Nm	25 - 250 in-lb	250 - 2,500 in-lb
AUET/MTM-500-1200	5.7 - 56.5 Nm	13.6 - 135.6 Nm	50 - 500 in-lb	120 - 1,200 in-lb
AUET/MTM-500-2500(-DC)	5.7 - 56.5 Nm	28.2 - 282.5 Nm	50 - 500 in-lb	250 - 2,500 in-lb

Custom sizes are also available. Contact an AIMCO Customer Service Associate for ordering options, 1-503-254-6600, or toll free 1-800-852-1368.



Rundown Fixtures

Torque Measurement: Rundown Fixtures

Features and Benefits

- Enables accurate and repeatable testing of pneumatic or electric power tools
- Mechanical Belleville system of bolt, nut or nut body, Belleville washers and main housing, 1/4" - 3/4" drive sizes, 10 in-lb - 1,200 ft-lb
- Fixtures can be ordered to simulate hard, med., or soft joints



ARDFA-XXXXHD
ARDIA-XXXXHD

ARDFA-XXXHDS
ARDIA-XXXHDS

ARDFA-XXXHDE
ARDIA-XXXHDE

ARDFA-XXX
ARDIA-XXX

Wear-Resistant Heavy Duty	X			
Heavy Duty, Fully Encapsulated		X		
Heavy Duty, Encapsulated Washers			X	
Standard (Included w/analyzer)				X
Spline Drive				
Used in Conjunction with External Transducer				
ASTIS	X	X	X	X
AISI / AISF	X	X	X	X
ARTIS	X	X	X	X

*Spline drive feature provides rundown control when testing pulse tools.



HDS Series

HD Series

HDE Series

AUDITOR RUNDOWN FIXTURES

To test power tools, pneumatic or electric, consistent rotational speed must be achieved. The joint rundown fixture/simulator provides the means by which the tool motor and spindle rotates freely at the start of the test cycle and then develops torque as rotation resistance increases as fastener/joint load increases. The linearity and consistency of the joint rundown fixtures/simulators vary greatly and the tool test data is a product of the variations in these rundown fixtures. Higher quality joint rundown fixtures produce torque data with less scatter.

ARDIA Models

Model*	Recommended Torque Range		Square Drive
	NM	IN-LB	
ARDIA-10(HD)(HDE)(HDS)	.13 - 1.13	1.0 - 10	1/4"
ARDIA-25(HD)(HDE)(HDS)	.28 - 2.8	2.5 - 25	1/4"
ARDIA-50(HD)(HDE)(HDS)	.56 - 5.6	5 - 50	1/4"
ARDIA-100(HD)(HDE)(HDS)	1.3 - 11.3	10 - 100	1/4"
ARDIA-150(HD)(HDE)(HDS)	1.7 - 16.9	15 - 150	1/4"
ARDIA-250(HD)(HDE)(HDS)	2.8 - 28.3	25 - 250	3/8"
ARDIA-350(HD)(HDE)(HDS)	4 - 40	35 - 350	3/8"
ARDIA-500(HD)(HDE)(HDS)	5.6 - 56.5	50 - 500	3/8"
ARDIA-750(HD)(HDE)(HDS)	8.5 - 84.7	75 - 750	3/8"
ARDIA-1000(HD)(HDE)(HDS)	11.3 - 113	100 - 1,000	3/8"

*Add "HD" to part numbers for wear resistant models. Add "HDS" to part numbers for fully encapsulated wear resistant models.

*Add "HDE" to part numbers for partial encapsulated wear resistant models.

ARDFA Models

Model*	Recommended Torque Range		Square Drive
	NM	FT-LB	
ARDFA-100(HD)(HDE)(HDS)	13.6 - 136	10 - 100	1/2"
ARDFA-150(HD)(HDE)(HDS)	20.4 - 204	15 - 150	1/2"
ARDFA-250(HD)(HDE)(HDS)	34 - 340	25 - 250	1/2"
ARDFA-500(HD)(HDE)(HDS)	67.8 - 678	50 - 500	3/4"
ARDFA-600(HD)(HDE)(HDS)	81.6 - 816	60 - 600	3/4"
ARDFA-750(HD)(HDE)(HDS)	101.7 - 1,017	75 - 750	3/4"

* Add "HD" to part numbers for wear resistant models. Add "HDS" to part numbers for encapsulated wear resistant models.

* Add "HDE" to part numbers for partial encapsulated wear resistant models.

A-50 Screw Presenters

For semi-automated assembly, look no further than AIMCO's Acra-Feed screw presenters

Productive

- One-hand operation eliminates manual handling of screws. Screw is presented to operator for easy magnetic or vacuum pickup
- Keeps workspace clear of dropped fasteners and stray fasteners from getting into assemblies
- Large hopper holds approximately 1,000 – 1,500 fasteners, and the oscillating hopper design provides a quick feed rate – up to two (2) screws per second
- Solid design – no tie downs or straps required
- Perfect for contract or dedicated assembly
- Switch rails in minutes for different screw sizes

Ergonomic

- Allows for fewer arm and hand movements

Reliable

- Heavy duty industrial design
- Modular design for easy repairs

Quality

- Uses existing or our new torque control drivers



Acra-Feed® Screw Presenter



FASTENING IN 3 EASY STEPS



Load screws into the hopper. There is no side to load unit and no gates to limit capacity.



Address screw with magnetized bit.



Bring screw to workpiece and fasten parts.



A-50B-1
Standard Screw Presenter

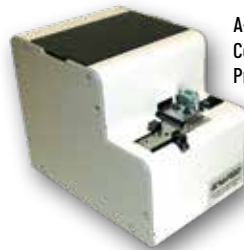

A-50BRBTC-4
Compact Robotic Screw
Presenter



A-50BRBT-1
Robotic Screw
Presenter

A-50 Standard Screw Presenters

For manual assembly stations where the operator must otherwise pick up and hold fasteners by hand.

Model	Additional Rail Part No.	Screw Size		Max Screw Length	
		IN	MM	IN	MM
A-50A-0	AR-0	#0	1.4	.39	10
A-50A-1.7	AR-1.7	—	1.7	.39	10
A-50B-1	BR-1	#1	2.0	.75	18
A-50B-2	BR-2	#2	2.3	.75	18
A-50B-3	BR-3	#3	2.6	.75	18
A-50B-4	BR-4	#4	3.0	.75	18
A-50C-6	CR-6	#6	3.5	.75	18
A-50C-8	CR-8	#6-8	4.0	.75	18
A-50C-10	CR-10	#10	5.0	.75	18

Dimensions: 5.1 (W) x 8.5 (L) x 5.3 (H) Weight: 7.0 lb.

A-50ARBTC Compact Robotic Screw Presenters

For automated systems or manual systems using vacuum-assist to pick up nonferrous fasteners when work space is limited.

Model	Additional Rail Part No.	Nominal Screw Size		Max Screw Length	
		IN	MM	IN	MM
A-50ARBTC-0	AR-RBTC-0	#0	1.4	.390	10
A-50ARBTC-1.7	AR-RBTC-1.7	—	1.7	.390	10
A-50BRBTC-1	BR-RBTC-1	#1	2.0	.700	18
A-50BRBTC-2	BR-RBTC-2	#2	2.3	.700	18
A-50BRBTC-3	BR-RBTC-3	#3	2.6	.700	18
A-50BRBTC-4	BR-RBTC-4	#4	3.0	.700	18
A-50CRBTC-6	CR-RBTC-6	#6	3.5	.700	18
A-50CRBTC-8	CR-RBTC-8	#6-8	4.0	.700	18
A-50CRBTC-10	CR-RBTC-10	#10	5.0	.700	18

Dimensions: 7.2 (L) x 4.9 (W) x 5.7 (H) Weight: 6.7 lb.

A-50ARBT Robotic Screw Presenters

For automated fastening systems or manual systems using vacuum assist to pick up non-ferrous fasteners.

Model	Additional Rail Part No.	Screw Size		Max Screw Length	
		IN	MM	IN	MM
A-50ARBT-0	AR-RBT-0	#0	1.4	.39	10
A-50ARBT-1.7	AR-RBT-1.7	—	1.7	.39	10
A-50BRBT-1	BR-RBT-1	#1	2.0	.70	18
A-50BRBT-2	BR-RBT-2	#2	2.3	.70	18
A-50BRBT-3	BR-RBT-3	#3	2.6	.70	18
A-50BRBT-4	BR-RBT-4	#4	3.0	.70	18
A-50CRBT-6	CR-RBT-6	#6	3.5	.70	18
A-50CRBT-8	CR-RBT-8	#6-8	4.0	.70	18
A-50CRBT-10	CR-RBT-10	#10	5.0	.70	18

Dimensions: 5.1" (W) x 10.8" (L) x 5.3" (H) Weight: 9.2 lb.

Optional Accessories

Model	Part No.
Mag-D-Net Bit Magnetizer	AM1/4Z, AM5Z, AM3/16Z, AM5/16Z



Acra-Feed Automatic Screw Feed Systems

Reduces Cycle Time By Approximately Two Seconds Per Fastener

FEATURES AND BENEFITS

- Delivers fastener directly to the driver
- For #2 - #10 fasteners, up to 1 inch long
- Available for captive washer type screws (A315V)
- Feed speed of up to 1 screw per second
- System includes feeder, hose assembly, air screwdriver, and FRL

Productive

- Eliminates reaching for fasteners
- Most jams are easily cleared on the line
- Frees operator's hand for productive use
- Large hopper holds between 1,000 - 5,000 fasteners

Ergonomic

- Eliminates manual handling of fasteners and shavings
- Reduces workspace clutter
- Keeps workspace clean of dropped fasteners
- Torque reaction of standard driver is minimal and can be eliminated with optional Ergo-Arm

Reliable

- Longest warranty in the industry – 3 years
- Rocking Bar design only operates as needed
- "Photo eyes" maximize motor life
- Design eliminates burrs and shavings by minimal handling of the fastener
- Durable head assembly lasts for years
- There are more Acra-Feed systems in use than any other system



Acra-Feed Screw Feed Systems

Model	Applicable Screws	Screw Length		Hopper Capacity	Max Fastening Speed	Weight (Lb)	Dimensions L x W x H (In)
		IN	MM				
A2100 Series	M2-M5 (#2 - #10)	1/4-1	6-25	1,500cc (1,000-5,000 pcs)*	60 screws/min*	68	7 x 17 x 16
A315V Series	M2-M5 (#2 - #10)	1/4-1	6-25	450cc (500-2,500 pcs)*	60 screws/min*	74	10 x 21 x 16

* Dependent on screw size

Delivery Hose: 10 ft

Air Pressure: 85 psi

Power: AC 110V, 20W, AC 220V by request. Contact AIMCO at 1-503-254-6600, or toll free 1-800-852-1368.

HOW TO ORDER: Acra-Feed systems are application-specific and configured to the unique workpiece and requirements of the user. Quotations are provided from a review of sample workpieces, 25 fasteners, and required torque specifications.

Gravity-Defying Balancers

TW SERIES BALANCERS



TW-0 and TW-00

- Gravity defying / "true balance"
- No tension buildup to cause worker fatigue
- Easy external direct drive tensioning
- 360° upper swivel
- Safety cable provision
- Tool clip included



TW-3 through TW-70

- Tapered drum allows "true balance" throughout cable travel
- Easy external direct drive tensioning
- Cast aluminum casing for durability
- Permanent lubrication
- 360° top swivel
- Enclosed spiral spring for added safety
- Safety chain provision (TW-3 through TW-15 models)
- Automatic safety lock plus manual drum lock (TW-22 through TW-70)

TW Series Balancers

Model	Capacity		Anti-Gravity Capacity (LB)	Cable
	LB	KG		
TW-00	1.1 - 3.3	0.5 - 1.5	2.5 - 3.0	18" stranded steel cable 1/8" dia.
TW-0	1.1 - 3.3	0.5 - 1.5	2.5 - 3.0	3.3-ft stranded steel cable 1/8" dia..
TW-3	2.2 - 6.6	1.0 - 3.0	4.5 - 6.0	4.3-ft stranded steel cable 5/32" dia.
TW-5	5.5 - 11.0	2.5 - 5.0	8.0 - 10.5	4.3-ft stranded steel cable 5/32" dia.
TW-9	9.9 - 19.8	4.5 - 9.0	15.0 - 19.0	4.3-ft stranded steel cable 5/32" dia.
TW-15	19.8 - 33.0	9.0 - 15.0	26.0 - 32.5	4.3-ft stranded steel cable 5/32" dia.
TW-22	33.0 - 48.4	15 - 22	41.0 - 48.0	5-ft stranded steel cable 3/16" dia.
TW-30	48.4 - 66.0	22 - 30	58.0 - 65.5	5-ft stranded steel cable 3/16" dia.
TW-40	66.0 - 88.0	30 - 40	77.5 - 87.5	5-ft stranded steel cable 3/16" dia.
TW-50	88.0 - 110.0	40 - 50	100.0 - 109.5	5-ft stranded steel cable 3/16" dia.
TW-60	110.0 - 132.0	50 - 60	122.0 - 131.0	5-ft stranded steel cable 3/16" dia.
TW-70	132.0 - 154.0	60 - 70	144.0 - 153.0	5-ft stranded steel cable 3/16" dia.

ASB SERIES BALANCERS

- Built-in Safety Features: The cable, drum, and enclosed spring are fully visible without opening the unit for easy and convenient safety checks. The sturdy spiral spring is enclosed for greater control and safety
- Ergonomic Spring Release: The automatic safety lock provides extra control
- Extended Cable Length: Stainless steel cables allow for extended reach on applications
- Enhanced Gear Mechanism: Allows for more exact adjustment of tension
- No Recoil and Low Resistance: Tapered drum style provides gravity defying tool positioning and low travel



ASB-0C Gravity Defying and Hand Adjustable Balancer



ASB-3C
ASB-5C

ASB Series Balancers

Model	Capacity		Stroke		Weight	
	lb	kg	in	cm	lb	kg
ASB-0C	1.1 - 3.3	0.5 - 1.5	51.1	130	1.5	0.7
ASB-3C	3.3 - 6.6	1.5 - 3	86.4	220	3.0	1.4
ASB-5C	5.5 - 11	2.5 - 5	86.4	220	3.4	1.5



Line Reel Balancers / Retractors

LINE REEL BALANCERS

LR Series

- Designed for light duty applications with small pneumatic tools
- Integrating air hose and support cable keep work areas clean
- Adjustable ball stop for optional positioning
- 1/4" I.D. polyvinyl hose with 1/4" NPT inlet
- 360° upper swivel
- Maximum 142 PSI



LR Series Line Reel Balancers

Model	Hose Length	Capacity
LR-09B-90	35.5 in 90 cm	3 lb 1.5 kg
LR-09B-200	78.3 in 199 cm	3 lb 1.5 kg

RETRACTORS

RPA Series

- No tools needed to set tension
- 5 ft nylon coated steel cable
- Reinforced hanging bracket includes safety cable provision
- Adjustable cable stop
- Three (3) models support weight 0.5 – 5 lb
- Tool clip included

RMA-L Series

- Steel housing with polyester finish
- Reinforced hanging bracket includes safety cable provision
- 8 ft of 3/32" diameter coated steel cable
- Permanently lubricated
- Tool clip included
- External tension adjustment
- Ratchet cable lock



RPA / RMA-L Series Retractors

Model	Capacity
RPA-1	0.5 - 1.5 lb 0.2 - 0.7 kg
RPA-2	1.5 - 3.0 lb 0.7 - 1.4 kg
RPA-3	3.0 - 5.0 lb 1.4 - 2.3 kg
RMA-7L	5 - 10 lb* 2.3 - 4.8 kg*
RMA-15L	10 - 15 lb* 4.5 - 6.8 kg*
RMA-20L	15 - 23 lb* 6.8 - 10.4 kg*

*With ratchet lock

Ergo Arm Tool Support Systems

ERGO ARMS

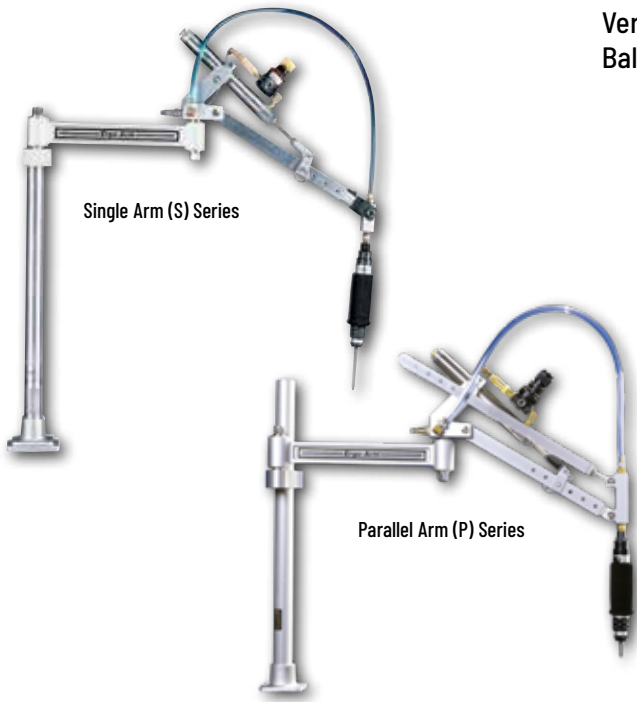

Versatile Ergo Arms Absorb Torque Reaction while Perfectly Balancing Tool Weight

AIMCO's Ergo Arms reduce operator fatigue for electric and pneumatic tools. The versatile, easy-to-assemble kits include both single and parallel rails for customizing tool rigidity to the customer's preference.

The durable, lightweight construction provides minimal resistance and low inertia during high-cycle use. The adjustable height, length, and elbowed joint increases accessibility with minimal travel to the fastening application.

Tools recommended for use with this arm:

- AcraDyne 1000 and 2000 Series
- Uryu LT Series Pneumatic Screwdrivers
- Electra Electric Screwdrivers
- Inline Tools

SPECIAL FEATURES OF ERGO ARMS

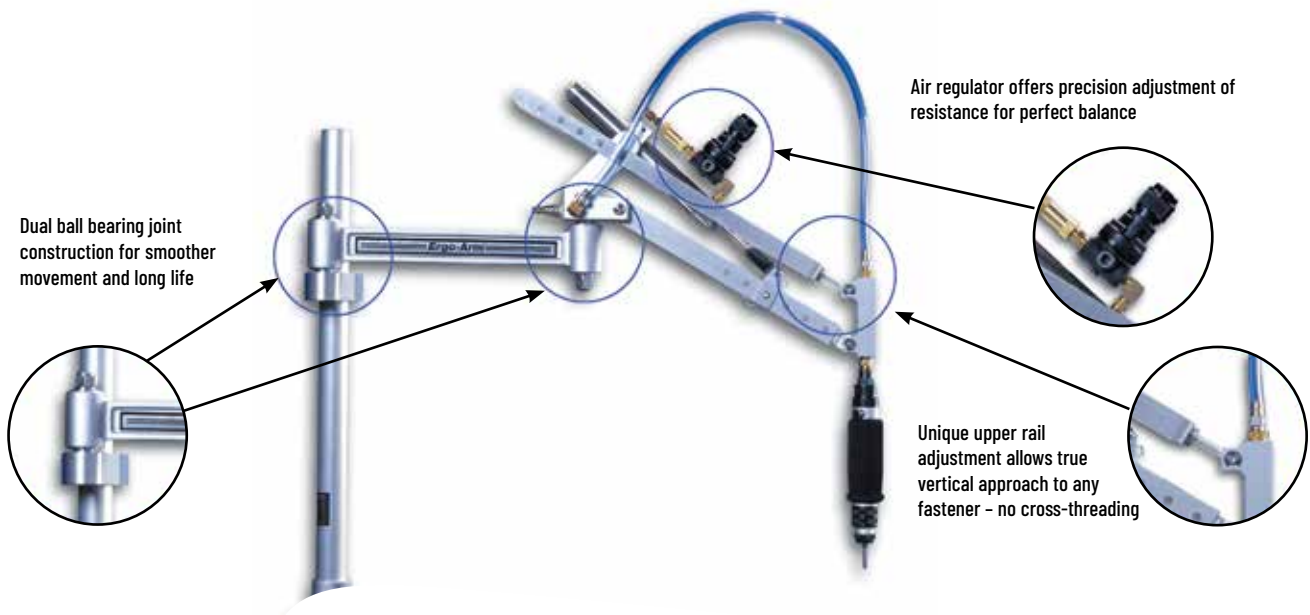

Ergo Arm Tool Support Systems

ERGO ARM FEATURES AND BENEFITS



PARALLEL ARM SERIES

AD-D1098-P, AD-D1098-PAC, AD-D1098-PACE

- Allows for freedom of movement
- Vertical adjustment eliminates cross-threading
- Fixtured tool increases repeatability
- Adjustable reach
- Available in air or oil cylinder models
- Electric tool mount standard on PACE model

SINGLE ARM SERIES

AD-D1098-S, AD-D1098-SAC

- Full tool rotation
- Allows for freedom of movement
- Adjustable reach
- Compatible with automatic screw feeder
- Available in air or oil cylinder models

AD Series Ergo Arms

Model	Arm Style	Tool Mount	Reach		Capacity		Maximum Torque*	
			IN	MM	LB	KG	IN-LB	NM
AIR CYLINDER SERIES								
AD-D1098-SAC	Single	Air manifold	4 - 33	102 - 838	0 - 15	0 - 7	110	12
AD-D1098-PAC	Parallel	Air manifold	4 - 33	102 - 838	0 - 15	0 - 7	110	12
AD-D1098-PACE	Parallel	Electric	4 - 33	102 - 838	0 - 15	0 - 7	110	12
OIL CYLINDER SERIES								
AD-D1098-S	Single	Air manifold**	4 - 33	102 - 838	0 - 15	0 - 7	110	12
AD-D1098-P	Parallel	Air manifold	4 - 33	102 - 838	0 - 15	0 - 7	110	12

* Max torque allowed may be dependent on tool clutch type and joint rate

** For single arm electric tool mount, order EAP-202ED-KIT

Linear Arms

AFA SERIES LINEAR ARMS



Ergonomic Support for Electric and Pneumatic Tools Reduces Operator Fatigue

AIMCO's linear arms are lightweight and designed for smooth and easy handling of electric and pneumatic tools. Arms are available in torque ranges of 5 Nm to 400 Nm and with reaches ranging from 12.5 in. to 36 in.

The AFA Series (AIMCO Folding Arm) is configured with aluminum alloy beams connected by an elbow joint for working with tools in tight spaces.

Tools recommended for use with this arm:

- AcraDyne 1000 and 2000 Series
- Uryu LT Series Pneumatic Screwdrivers
- Electra Electric Screwdrivers
- Inline Tools

FEATURES AND BENEFITS

AFA Series

- Constructed of lightweight aluminum
- Improves fastening quality and productivity
- Maintains Perpendicularity of the tool to the application
- Folding elbow joint allows for closer reach to post for tight workspaces
- Absorbs torque reaction
- Counterbalances tool mass

AFA Series Linear Arms

Model	Max. Torque		Max. Tool Weight		Reach		Tool Diameter	
	NM	FT-LB	KG	LB	MM	IN	MM	IN
AFA Series With Folding Arm								
AFA5-400	5	3.7	2	4.4	0 - 470	0 - 18.5	23 - 40	1.0 - 1.6
AFA15-400	15	11.1	3	6.6	0 - 470	0 - 18.5	23 - 40	1.0 - 1.6
AFA10-550	10	7.4	2	4.4	0 - 620	0 - 24.2	23 - 40	1.0 - 1.6



Workstation Components and Assemblies

COMPONENTS

TRACK

Steel with beige polyester finish. Use for vertical and horizontal workstation support.

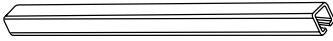

PART NUMBER	30# TRACK
AT3-3	3 ft track
AT3-4	4 ft track
AT3-6	6 ft track
AT3-9*	9 ft track

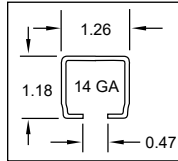

PART NUMBER	50# TRACK
AT5-3	3 ft track
AT5-4	4 ft track
AT5-6	6 ft track
AT5-9*	9 ft track
AT5-12*	12 ft track

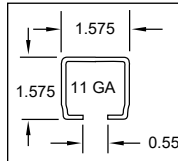

TRACK NUT (ATN-3/5)

Zinc plated steel. Use to attach accessories to track, as end stops, or to isolate rolling accessories.

- ATN-3 for 30 lb. track
- ATN-5 for 50 lb. track



END STOP (AES-3/5)

Zinc oxide finish. Use to prevent balancer trolley from "overtraveling" horizontal track.

- AES-3 for 30 lb. track
- AES-5 for 50 lb. track

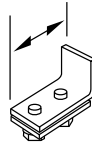

MOUNTING PLATE (AMP-5)

Black polyester finish. Use as a base to mount vertical uprights.

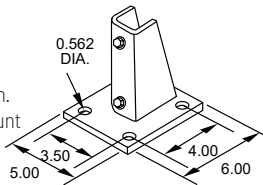

END CAP (AEP-3/5)

Black molded vinyl. Use to cap track ends for a professional finish.

- AEP-3 for 30 lb. track
- AEP-5 for 50 lb. track

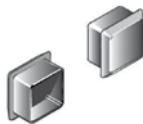

ANGLE BRACKET (AB-3/5)

Black polyester finish. Use to mount horizontal track to vertical track.

- AB-3 for 30 lb. track
- AB-5 for 50 lb. track

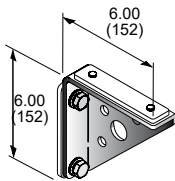

JOINT HANGER BRACKET (AJH-3/5)

Black polyester finish. Use to couple and hang end-to-end track.

- AJH-3 for 30 lb. track
- AJH-5 for 50 lb. track

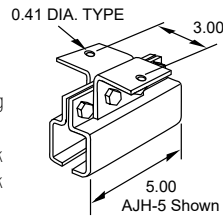

BALANCER TROLLEY (ABT-3/5)

Black polyester finish. Use as moving support for tool balancers, hose, and cable. Quality ball bearing wheels for long life and smooth tracking.

- ABT-3 for 30 lb track (1.00 dia)
- ABT-5 for 50 lb track (1.25 dia)

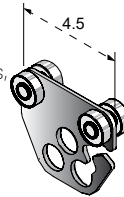

HANGER BRACKET (AHB-3/5)

Black polyester finish. Use to suspend track at right angle.

- AHB-3 for 30 lb. track
- AHB-5 for 50 lb. track

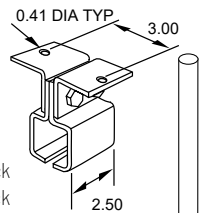

VERTICAL COLUMN (AVC-5*)

Beige polyester finish, 3" diameter x 9 ft upright steel column with welded base. Use as floor mount for extra stability with jibs or workstation components.

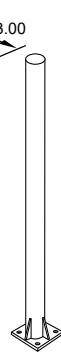

HOSE/CABLE TROLLEY

Black polyester finish. Use for moving cable or hose festoon. Supports hose cable OD .60-.94.

- AIC5-2 for 50 lb. track

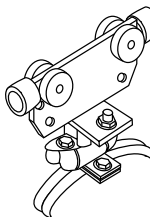

U-BOLTS (AUB-5)

Zinc plated steel. Use to secure boom bracket, or any flat metal plate, to AVC-5 (sold individually).

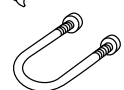

SUPPORT CLAMPS (ASC-3/5)

Black polyester finish. Use as additional support for track.

- ASC-3 for 30 lb. track
- ASC-5 for 50 lb. track

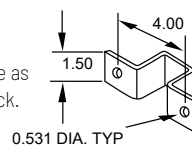

TOOL CLIP (SH-5)

Steel clip with safety latch. Use for tool attachment and as replacement clip for lightweight tool balancers. Measures 2.37" long.



90° CONNECTOR FOR 3/8" HOSE (WSCH)

3/8" I.D. Brass. Use to provide stable transfer point from air line to tool. 90 degree connector attaches to ABT-5.

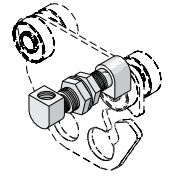

WALL- AND FLOOR- MOUNTED JIBS

3 FT. SWINGING JIB (AW3S)

3 FT. FIXED JIB (AW3F)

3 FT. SWINGING JIB FOR CHANNEL MOUNT (AJS3**)

Jibs are mounted to wall or beams to create free standing workstations. End stop, end cap, and balancer trolley included. Maximum weight: 30 lb.

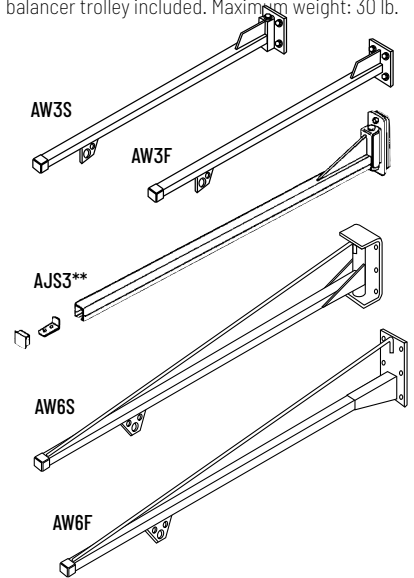

6 FT. SWINGING JIB (AW6S)

6 FT. FIXED JIB (AW6F)

Jibs can be wall mounted or attached to vertical column (AVC-5) to create a freestanding workstation. End stop, end caps, and balancer trolley are included. Maximum weight: 50 lb.

All complete assemblies are beige polyester finish and include balancer trolley, end caps, and end stops. Floor mounted assemblies are not able to ship via UPS.

When choosing a workstation system, remember...

Total weight capacities should include tool balancer, hose/cable, and tool/fixture. Units need to be supported vertically and horizontally every 6 ft.

** Additional freight may apply

** AJS3 Does not include balancer trolley

Workstation Components and Assemblies

FLOOR MOUNTED 3 FT. FIXED JIB* (AW3FMF)

Maximum weight: 30 lb
Column height: 6 ft

FLOOR MOUNTED 6 FT. SWINGING JIB* (AW6FMS*)

FLOOR MOUNTED 6 FT. FIXED JIB* (AW6FMF*)

Maximum weight: 50 lb
Column height: 9 ft

*Units include end stop,
balancer trolley and intermediate carrier.

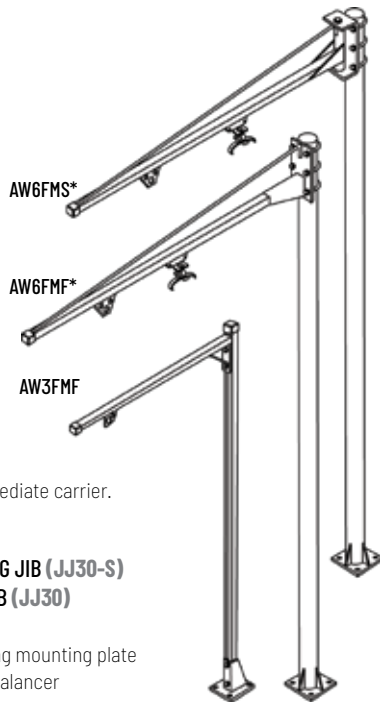

BENCH MOUNTED SWINGING JIB (JJ30-S) BENCH MOUNTED FIXED JIB (JJ30)

Maximum weight: 30 lb
Column height: 48" including mounting plate
3 ft. swinging jib includes balancer
trolley, end stop, and cap

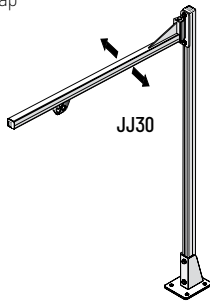

AIMCO WORKSTATION KIT

BENCH MOUNTED WORKSTATION WITH TORQUE ARM (JJ30-TA**)

- 5 lb. maximum weight (RPA-3 included)
- 5' column height including mounting plate
- 38" jib length (swinging)
- 15 ft-lb torque rating
- 3/8" NPT inlet
- 1/4" NPT outlet
- Beige polyester finish
- 1/4" braided air hose
- 21" maximum vertical arm travel

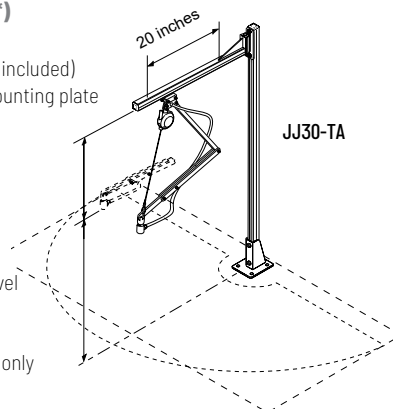

**Additional freight may apply
**For use with pneumatic tools only

CREATE A CUSTOM SUPPORT SYSTEM USING AIMCO'S QUALITY PRODUCTS

- Organize work area to create a safe, productive working environment
- Reduce risk of injury to assembler by providing support for heavy tools
- Protect valuable tools, fixtures, and monitoring devices from damage by suspending them out of the way

AIMCO BASIC WORKSTATION KIT (ATW-50)



- 50 lb maximum weight capacity
- 48" uprights
- 36" extensions
- Table mounts included
- 6' tool rail with rolling trolley included
- All necessary hardware included

TROLLEY MOUNTED TORQUE ARM WITH 3-LB RETRACTOR AND HOSE (FA-50-2*)

Ergonomic arm absorbs torque reaction.
Moves front to back along overhead jib.

(TA-50-2)

Moves side to side on overhead track.

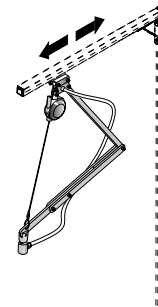

TOOL BASKET (21226)

Mounts easily to any work area to
hold pistol and angle style tools.

AIMCO can customize a workstation for you.

Contact an AIMCO Customer Service Associate 1-503-254-6600, or toll free 1-800-852-1368.



Air Preparation Units

AFRL STACKING FILTER/REGULATORS

Stacking filter/regulator combinations provide air filtration and precise regulation in a single unit for easy mounting and installation.

FEATURES AND BENEFITS

- All models include L-mount bracket, gauge, and metal bowl shields
- Polycarbonate filter and lubricator bowls (metal bowls standard on AFRL-8)
- 25-micron filter included on all models
- Regulating range: 7 - 125 PSI
- Custom order upgrade items include metal bowl, 5 micron filter, semi-automatic filter drain, and reduced PSI range regulator. Contact an AIMCO Customer Service Associate for more information, 1-503-254-6600, or toll free 1-800-852-1368
- **Maximum allowable Input Pressure not to exceed 120 PSI**



AFRL-2-C
AFRL-3-C

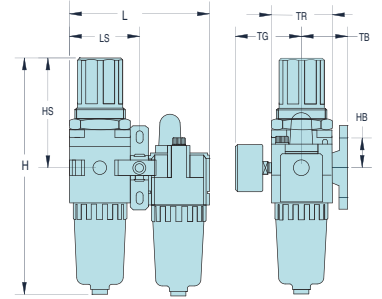

AFRL-3
AFRL-4
AFRL-8

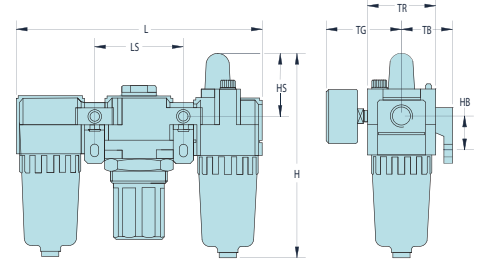

28178
HT Air Tool/AFRL
Carrying Kit



AFRL-4HTA
Standalone Unit

AFRL Stacking Filter/Regulators

Model	Port	Gauge Port	Flow Rate		Bowl Shield	H	HB	HS	L	LS	TB	TG	TR
			CFM	L/MIN		IN/MM	IN/MM	IN/MM	IN/MM	IN/MM	IN/MM	IN/MM	IN/MM
AFRL-2	1/4"	1/8"	70	2,000	yes	6.16 (156.5)	1.39 (35.3)	1.50 (38.1)	7.13 (181.1)	2.52 (64.0)	1.61 (41.0)	2.39 (60.7)	2.09 (53.1)
AFRL-2-C	1/4"	1/8"	60	1,700	yes	8.31 (211.1)	1.38 (35.1)	3.64 (92.5)	4.61 (117.1)	2.30 (58.4)	1.61 (40.9)	2.39 (60.7)	2.09 (53.1)
AFRL-3	3/8"	1/4"	140	4,000	yes	7.54 (191.5)	1.57 (40.0)	1.61 (40.9)	9.37 (238.0)	3.31 (84.1)	1.97 (50.0)	2.58 (65.5)	2.76 (70.1)
AFRL-3-C	3/8"	1/4"	105	3,000	yes	10.31 (261.9)	1.57 (39.9)	4.41 (112.0)	6.06 (153.9)	3.03 (77.0)	1.97 (50.0)	2.58 (65.5)	2.76 (70.1)
AFRL-4	1/2"	1/4"	140	4,000	yes	7.54 (191.5)	1.57 (40.0)	1.61 (40.9)	9.37 (238.0)	3.31 (84.1)	1.97 (50.0)	2.58 (65.5)	2.76 (70.1)
AFRL-8	1"	1/4"	180	5,000	yes	10.69 (271.5)	1.97 (50.0)	1.89 (48.0)	11.81 (300.0)	4.13 (104.9)	2.75 (69.9)	2.97 (75.4)	3.54 (89.9)

Air Preparation Units: Basic Functions

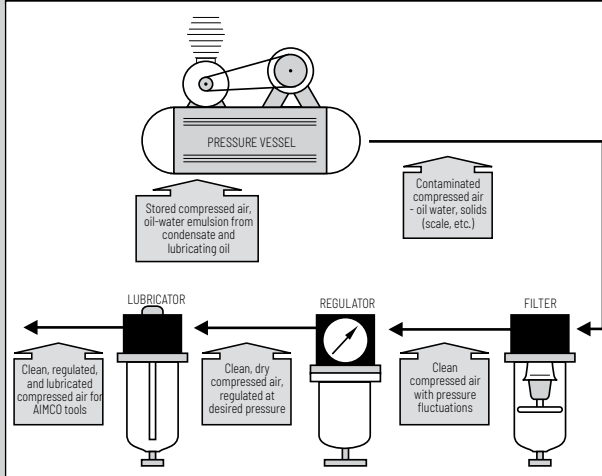

The supply of clean, dry air is essential to the operation of pneumatic powered tools. Use only clean filtered air for longer tool life. Provide proper airflow (CFM) and regulate air pressure (PSI) for optimum performance.

To determine unit size for application, you need to know:

- Total air flow (CFM) required for application
- Size of incoming air line and size of air line required by tool
- Air supply pressure (PSI)
- Allowable pressure drop
- Does the application require lubrication?
- Does the overall system have the required capacity?

Air Line

Polyurethane Hose



- Durable Polyurethane is chemical resistant and lightweight, and provides excellent recoil memory and maximum flexibility
- Available in transparent hose color (opaque also available)
- Assemblies for coiled hose include reusable swivel fitting. Straight hose available with or without fittings
- Working temperature: -104° F to 175° F

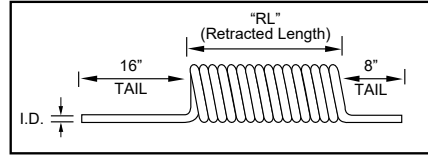

Single Air Hose Assemblies (Coiled)

Model	Description (O.D. x I.D. x Length)	Retracted Length	Working Pressure	Npt Fittings
ASH-250C-10MSZ	3/8" x 1/4" x 10'	7"	100 psi	1/4"
ASH-250C-15MSZ	3/8" x 1/4" x 15'	9-1/2"	100 psi	1/4"
ASH-250C-25MSZ	3/8" x 1/4" x 25'	15-1/2"	100 psi	1/4"
ASH-375C-15MSZ	9/16" x 3/8" x 15'	10"	100 psi	3/8"
ASH-375C-25MSZ	9/16" x 3/8" x 25'	14"	100 psi	3/8"
ASH-500C-15MSZ	3/4" x 1/2" x 15'	13"	100 psi	1/2"
ASH-500C-25MSZ	3/4" x 1/2" x 25'	23"	100 psi	1/2"

Custom length coil assemblies and special colors available in minimum order quantities. Contact an AIMCO Customer Service Associate, 1-503-254-6600, or toll free 1-800-852-1368.



Straight Air Hose (Sold Per Foot)

Model	Description
ASH-375Z	3/8" I.D.
ASH-500Z	1/2" I.D.

Contact an AIMCO Customer Service Associate about full reel pricing, 1-503-254-6600, or toll free 1-800-852-1368.

Rubber Hose



- Designed for use in a wide range of industrial, construction, and agricultural applications
- Constructed of high grade, reinforced EPDM synthetic rubber
- Working temperature: -40° F to 190° F

Single Air Hose (Rubber)

I.D.	O.D.	Length	Working Pressure	Weight
3/16"	0.44"	10 ft	200 psi	0.8 lb
1/4"	0.5"	10 ft	200 psi	0.9 lb
5/16"	0.58"	10 ft	200 psi	1.2 lb
3/8"	0.67"	10 ft	200 psi	1.5 lb
1/2"	0.81"	10 ft	200 psi	2.0 lb
5/8"	0.97"	10 ft	200 psi	2.7 lb
3/4"	1.12"	10 ft	200 psi	3.4 lb

Custom lengths available. Contact an AIMCO Customer Service Associate for more details, 1-503-254-6600, or toll free 1-800-852-1368.

Helpful Hints For Air Hose Use

- Use recommended I.D. air hose and fittings
- Replace air hose regularly to help maintain clean air
- A clear hose allows you to see water or dirt accumulation in hose
- Use correct length of hose to reduce air loss and pressure drop
- Use locking quick-disconnect couplers for additional safety



Air Line Accessories

BRASS QUICK COUPLERS

Manual ball couplers designed for use with ergonomic twist plugs. Brass with nitrile seals, rated to 300 PSI, from -40° to +250° F.



Model	Description
B23	1/4" NPT F x 1/4" QC Brass Coupler
B23E	1/4" NPT F x 3/8" QC Brass Coupler
B25	3/8" NPT F x 3/8" QC Brass Coupler

IN-LINE MINI REGULATORS

Easily adjust airflow with the turn of a dial.



Model	Capacity
932-100-0	1/8" NPT
932-110-0A	1/4" NPT

MINI AIR GAUGE SWIVEL JOINT KITS

- Bi-directional 360° rotation
- Keeps air hose straight and untwisted
- Decreases operator fatigue



Model	Inlet	Weight	Max Psi	Tool CFM
7021AG	1/4" NPT	3 oz	Up to 125	25
7041AG	3/8" NPT	3 oz	Up to 125	50



SWIVEL AIR FITTINGS

For use with most portable air tools, including grinders, drills, screwdrivers, buffers, sanders, staple guns, and more. Rotates 360° for awkward angles.

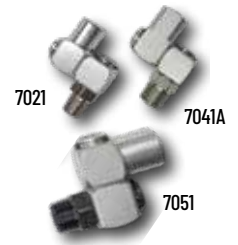

Model	Inlet	Weight	Max PSI	Tool CFM
7021	1/4" NPT	3 oz	Up to 125	25
7041A	3/8" NPT	11 oz	Up to 125	50
7051	1/2" NPT	7 oz	Up to 125	60

AIR LINE FITTINGS

Model	Capacity
250-RZ	1/4" NPT Rigid Fitting
250-SZ	1/4" NPT Swivel Fitting
375-RZ	3/8" NPT Rigid Fitting
375-SZ	3/8" NPT Swivel Fitting
500-SZ	1/2" NPT Swivel Fitting



BRASS ADAPTERS AND BUSHINGS

Pipe fittings for use as medium and low pressure connectors. Meets functional requirements of SAE J530, SAE J531, ASME and ASA. Rated 1,000 PSI from -65° to +250° F.



Model	Description
222P-6-4	3/8" NPT F x 1/4" NPT M Adapter
222P-8-6	1/2" NPT F x 3/8" NPT M Adapter
222P-12-8	3/4" NPT F x 1/2" NPT M Adapter
209P-6-4	1/4" NPT F x 3/8" NPT M Bushing
209P-8-6	3/8" NPT F x 1/2" NPT M Bushing

ERGONOMIC TWIST PLUGS

These unique, ergonomically designed hose fittings provide 360° rotation and 35° angled rotation in any direction.

- Two rotation points prevent kinking of air hose
- Design ensures full air pressure flow
- Rotating joint comes with polyurethane dust cover
- Heavy duty construction

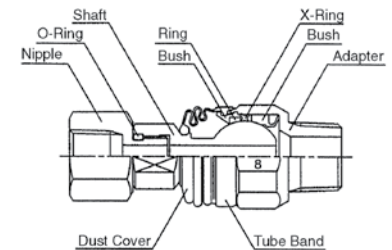
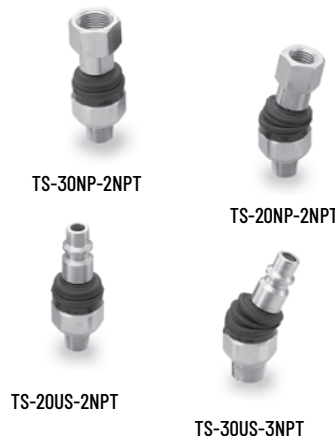

Model	Description
TS-30NP-2NPT	3/8" NPT Female x 1/4" NPT Male
TS-20NP-2NPT	1/4" NPT Female x 1/4" NPT Male
TS-20US-2NPT	1/4" US Plug x 1/4" NPT Male
TS-30US-3NPT	3/8" US Plug x 3/8" NPT Male



CORPORATE HEADQUARTERS
10000 SE Pine Street
Portland, Oregon 97216
Phone: (503) 254-6600
Toll Free: 1-800-852-1368

AIMCO CORPORATION DE MEXICO SA DE CV
Ave. Cristobal Colon 14529
Chihuahua, Chihuahua. 31125
Mexico
Phone: (01-614) 380-1010
Fax: (01-614) 380-1019

LIT-AT402M, Rev. 08-03-22
Printed in the USA ©2022 AIMCO

