

# UXR-2000 OIL-PULSE TOOLS

## EXPLODED VIEW

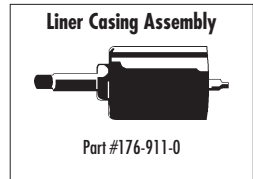
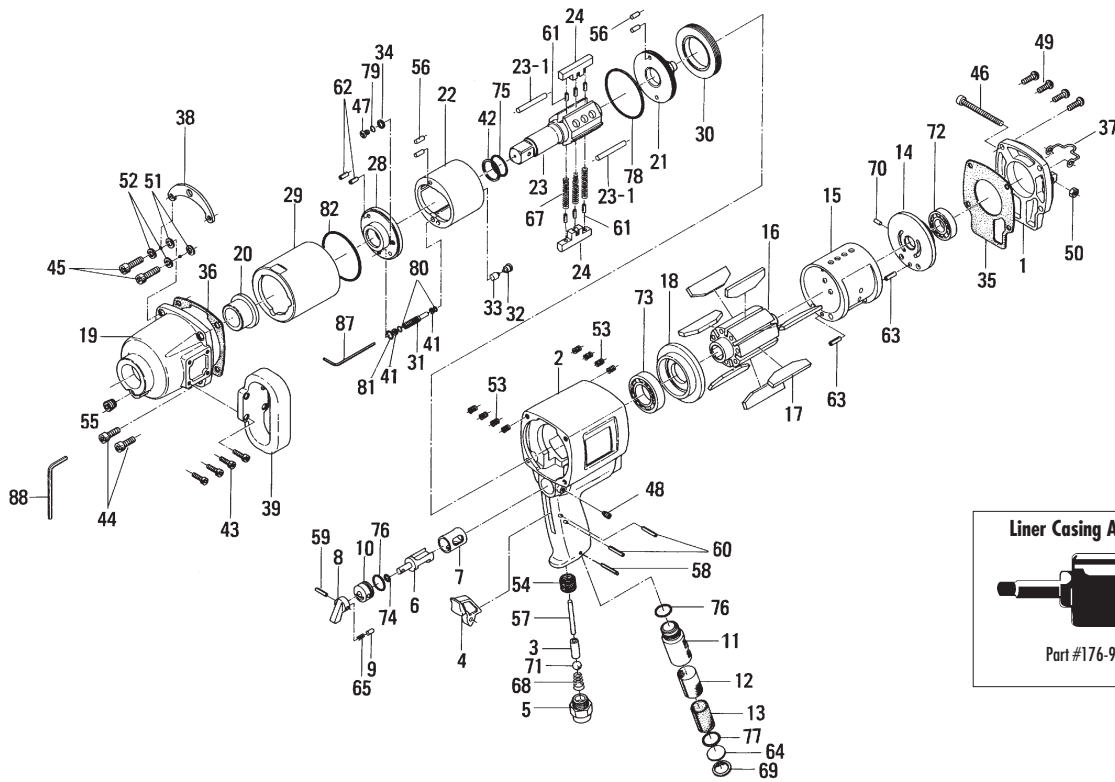

## PARTS LIST — FOR REFERENCE ONLY

Index Number	Part Number	Description	Qty.	Index Number	Part Number	Description	Qty.	Index Number	Part Number	Description	Qty.
1	194-012-1	Head Cover	1	32	194-969-9	Relief Valve Plug	1	60	973-118-0	Roll Pin (3 x 18)	2
2	194-025-1	Handle	1	33	194-970-8	Relief Valve	1	61	973-208-0	Roll Pin (4 x 8)	6
3	087-103-1	Valve Rod Bushing	1	34	188-807-1	Spacer	1	62	969-408-0	Pin (G) (5 x 10)	2
4	026-107-7	Throttle Trigger	1	35	194-853-8	Rear Packing	1	63	973-316-0	Roll Pin (5 x 16)	2
5	194-091-8	Air Inlet Bushing	1	36	194-867-8	Front Packing	1	64	975-603-0	Round Plate (24 x 1)	1
6	194-210-8	Reverse Valve	1	37	194-790-8	Suspension Bail	1	65	976-025-0	Spring (3 x 8.5)	1
7	194-211-8	Reverse Valve Bushing	1	38	194-794-8	Suspension Plate	1	67	976-797-0	Spring (6.35 x 45.5) (0.8) WPC	3 ●
8	023-212-4	Reverse Lever	1	39	090-721-1	Dead Handle	1	68	977-256-0	Cone Spring (10 x 15 x 22)	1
9	054-220-1	Reverse Lever Notch	1	41	944-005-0	Supporting Ring (4.2 x 6 x 1)	2 ●	69	979-017-0	Inner Snap Ring (24)	1
10	194-222-8	Reverse Lever Setter	1	42	944-225-0	Supporting Ring (25.2 x 29.4 x 1.5)	1 ●	70	980-009-0	Round Head Notch (4)	1
11	194-780-8	Exhaust Stack	1	43	945-112-0	Allen Head Bolt (M5 x 12)	4	71	981-032-0	Ball (7/16)	1
12	194-042-8	Silencer Ø0.2 x 30	1	44	945-220-0	Allen Head Bolt (M6 x 20)	2	72	982-203-0	Ball Bearing (6203)	1
	176-042-0	Silencer Ø0.21 x 60	>either/or	45	945-225-0	Allen Head Bolt (M6 x 25)	2	73	982-960-0	Ball Bearing (60/28)	1
13	176-835-0	Filter (K50)	1	46	945-265-0	Allen Head Bolt (M6 x 65)	1	74	990-205-0	O-Ring (JW1516-5)	1
14	194-285-9	Rear Plate	1	47	945-960-0	Hexagon Round Head Bolt (M6 x 8)	1	75	995-500-0	Teflon Seal (AR10400-12GC)	1 ●
15	194-286-8	Cylinder	1	48	952-210-0	Allen Head Dog Point Screw (M5 x 10)	1	76	990-918-0	O-Ring (SNS-20)	2
16	194-287-8	Rotor	1	49	945-965-0	Hex Round Head Bolt (M6 x 20)	4	77	990-919-0	O-Ring (SNS-22)	1
17	194-288-8	Blade	7	50	960-804-0	U-Nut (M6)	1	78	990-943-0	O-Ring (SNS-63)	1 ●
18	194-289-8	Front Plate	1	51	961-013-0	Flat Washer (6mm)	2	79	990-949-0	O-Ring (P-3) (NOK)	1 ●
19	194-439-8	Front Casing	1	52	962-078-0	Spring Washer (6.3 x 9.5 x 1.5)	8	80	990-972-0	O-Ring (SNS-4) (NOK)	2 ●
20	194-328-8	Anvil Bushing	1	53	965-021-0	Heli-Sert (M6 x 1.5D)	8	81	990-975-0	O-Ring (SNS-8) (NOK)	1 ●
21	194-901-8	Rear Liner Plate	1	54	965-120-0	Heli-Sert (M20 x 1D)	1	82	990-990-0	O-Ring (SNS-65)	1 ●
22	194-902-8	Liner	1	55	966-101-0	Allen Head Plug (1/4)	1				
23	18H-319-3	Anvil	1	56	970-408-0	Pin (H) (5 x 8)	4				
23-1	176-974-5	Roller (4.4 x 55)	2	57	970-452-0	Pin (H) (5 x 51.5)	1				
24	194-440-9	Driving Blade	2	58	971-166-0	Pin (2.5 x 26)	1				
28	176-904-0	Front Liner Plate	1	59	973-016-0	Roll Pin (2 x 16)	1				
29	194-905-8	Liner Casing	1								
30	194-906-8	Liner Casing Setter	1								
31	194-907-8	Relief Valve Spindle	1								

### ACCESSORIES

78-1	944-067-0	Supporter Ring (67 x 70 x 1)	1
87	939-111-0	Allen Wrench (6 mm) (125 x 60)	1
88	939-007-0	Allen Wrench (6 mm)	1

### FOOTNOTES

● = Items in Pulse Repair Kit UXR-2000-PRK



10000 SE PINE  
PORTLAND, OR 97216  
503-254-6600  
FAX 503-255-2615

When ordering spare parts, please specify tool type, part number, and description.

# UXR-2000-PRK

(Kit contains following parts)

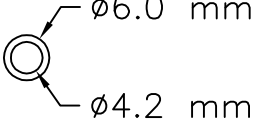
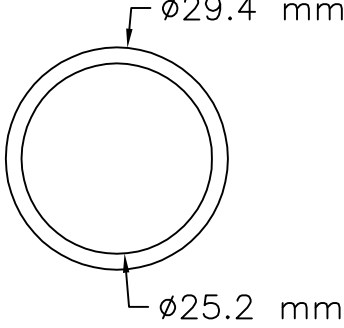
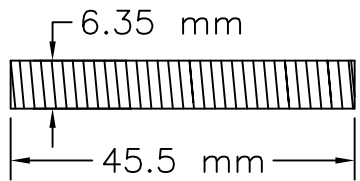
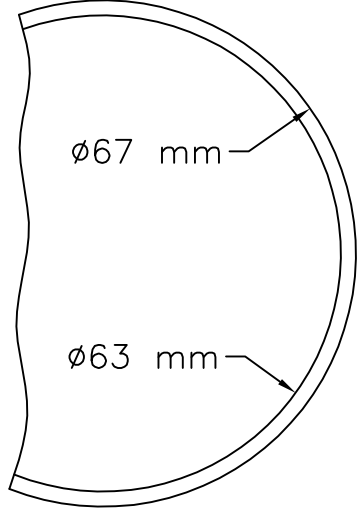
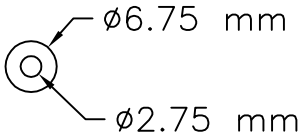
#/#	Bin Location	Part Number	QTY	Description	Material	Drawing / Scketch
1	PA10	944-005-0	2	Support Ring 4.2x6x1	Teflon-White	
2	PA10	944-225-0	1	Supporting Ring 25.2x29.4x1.5	Teflon-White	
3	PA1J	976-797-0	3	Spring 6.35x45.5	Spring wire ø.8 mm	
4	PA1B	990-943-0	1	O-Ring (SNS-63) 63x67x2	Buna-Black	
5	PA1C	990-949-0	1	O-Ring (P3) (NOK)	Buna-Black	

# UXR-2000-PRK

(Kit contains following parts)

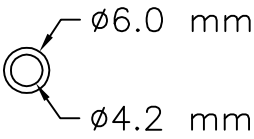
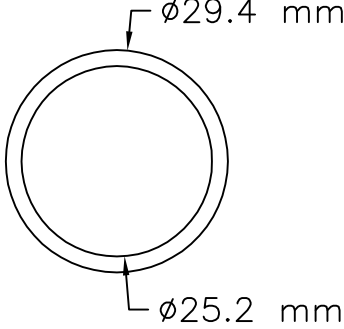
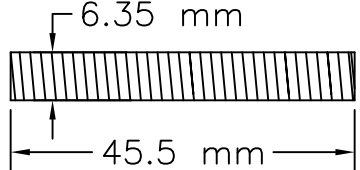
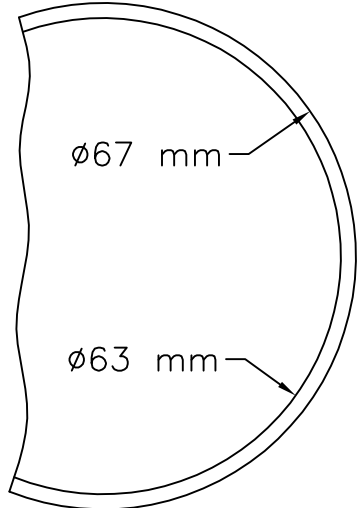
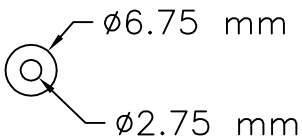
#/#	Bin Location	Part Number	QTY	Description	Material	Drawing / Scketch
1	PA10	944-005-0	2	Support Ring 4.2x6x1	Teflon-White	
2	PA10	944-225-0	1	Supporting Ring 25.2x29.4x1.5	Teflon-White	
3	PA1J	976-797-0	3	Spring 6.35x45.5	Spring wire ø.8 mm	
4	PA1B	990-943-0	1	O-Ring (SNS-63) 63x67x2	Buna-Black	
5	PA1C	990-949-0	1	O-Ring (P3) (NOK)	Buna-Black	

# UXR-2000-PRK

(Kit contains following parts)

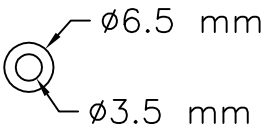
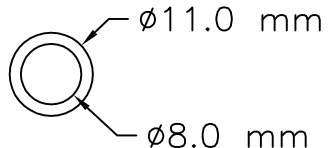
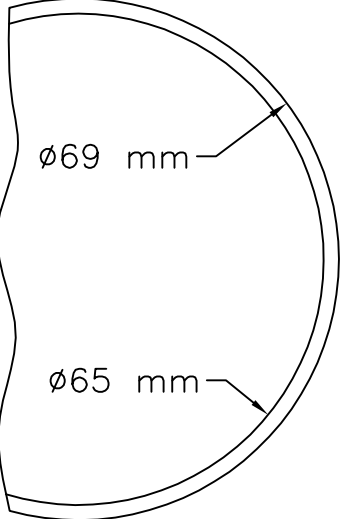
#/#	Bin Location	Part Number	QTY	Description	Material	Drawing / Scketch
6	PA1C	990-972-0	2	O-Ring (SNS-4) (NOK)	Buna-Black	
7	PA1C	990-975-0	1	O-Ring (SNS-8) (NOK) 8x11x1.5	Buna-Black	
8	PA1C	990-990-0	1	O-Ring (SNS-65) 65x69x2	Buna-Black	
9	PA10	995-500-0	1	Teflon Seal (120) 25x30x3.2	Teflon-Black	