

UX-450 & 450D OIL-PULSE TOOLS

EXPLODED VIEW

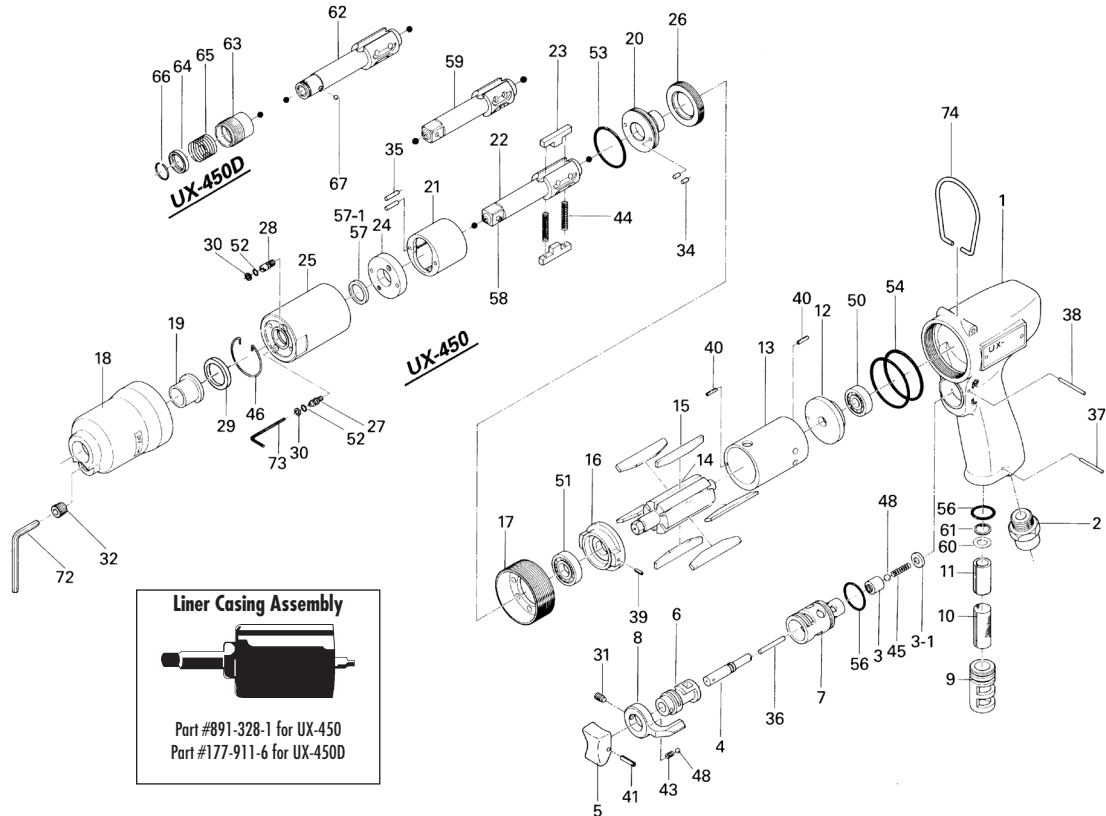

PARTS LIST — FOR REFERENCE ONLY

Index Number	Part Number	Description	Qty.	Index Number	Part Number	Description	Qty.	Index Number	Part Number	Description	Qty.
1	177-025-5	Casing	1	28	178-742-0	Oil Plug	1	57-1	944-213-0	Supporter Ring (12 x 16 x 1)	1
2	480-091-8	Air Inlet Bushing	1	29	178-327-0	Anvil Front Spacer	1	58	891-300-1	Socket Pin Assembly (3/8)	1
3	850-365-1	Valve	1	30	944-002-0	Supporting Ring (2.6 x 4.5 x 1)	2 ●	59	177-319-5	Anvil (0)	1
3-1	850-366-1	Valve Cover	1	31	952-106-0	Allen Head Dog Point Screw (M4 x 6)	1	60	996-403-0	Polyurethane Packing (11.5 x 4 x 2)	1
4	427-103-5	Valve Rod Bushing	1	32	966-110-0	Allen Head Plug (NPT1/16)	1	61	979-004-0	Inner Snap Ring (11)	1
5	177-107-5	Valve Lever	1	34	970-130-0	Pin (H) (2.45 x 4.5)	2	PARTS FOR UX-450D			
6	480-210-9	Reverse Valve	1	35	970-135-0	Pin (H) (2.45 x 11)	2	62	177-350-7	Driver Anvil	1
7	850-382-1	Reverse Valve Bushing	1	36	969-412-0	Pin (G) (2 x 12)	1	63	011-351-1	Bit Sleeve	1
8	480-212-8	Reverse Lever	1	37	971-120-0	Pin (2 x 20)	1	64	011-352-1	Bit Spacer	1
9	480-780-8	Exhaust Stack	1	38	971-123-0	Pin (2 x 23)	1	65	976-327-0	Spring (13.5 x 11)	1
11	177-835-6	Filter	1 ■	39	973-006-0	Roll Pin (2 x 6)	1	66	978-117-0	Snap Ring (11.7 x 1.0)	1
12	182-285-2	Rear Plate	1	40	973-008-0	Roll Pin (2 x 8)	2	67	981-002-0	Ball (1/8)	1
13	182-286-2	Cylinder	1	41	973-014-0	Roll Pin (2 x 14)	1	ACCESSORIES			
14	177-287-3	Rotor	1	43	976-006-0	Spring (3 x 5)	1	68	990-900-0	O-Ring, When Used	1 ●
15	182-288-2	Blade	6 ■	44	976-791-0	Spring (3.3 x 21) (0.4)	2 ●	72	939-105-0	Allen Wrench (4 mm)	1
16	182-289-2	Front Plate	1	45	976-229-0	Spring (3.2 x 13) (0.3)	1	73	939-091-0	Allen Wrench (1.5 mm)	1
17	177-036-5	Hammer Casing Connector	1	46	978-282-0	Snap Ring (28 x 1.0)	1	74	010-790-1	Suspension Ring	1
18	177-439-5	Front Casing	1	48	981-002-0	Ball (1/8)	2		182-924-2	Name Plate	1
19	190-328-6	Anvil Bushing	1	49	981-045-0	Ball (1.5)	2		930-205-0	Driver Rivet	2
20	196-901-4	Rear Liner Plate	1	50	982-401-0	Ball Bearing (EE-2)	1 ■	FOOTNOTES			
21	177-902-5	Liner	1	51	982-402-0	Ball Bearing (EE-3)	1 ■	● = Items in Pulse Repair Kit UX-450-PRK			
22	891-307-1	Anvil (OP-P)	1	52	990-320-0	O-Ring (ARP568-003)	2 ●	■ = Items in Repair Kit UX-450-RK			
23	177-440-5	Driving Blade	2	53	990-329-0	O-Ring (JW1530-19)	1 ●				
24	178-904-8	Liner Front Plate	1	54	990-337-0	O-Ring (JW1530-27)	2 ■				
25	177-905-6	Liner Casing	1	56	990-912-0	O-Ring (SNS-14)	2				
26	190-906-6	Liner Casing Setter	1	57	990-152-0	O-Ring	1 ●				
27	174-907-8	Relief Valve Spindle	1								



10000 SE PINE
PORTLAND, OR 97216
503-254-6600
FAX 503-255-2615

When ordering spare parts, please specify tool type, part number, and description.

FOOTNOTES

- = Items in Pulse Repair Kit UX-450-PRK
- = Items in Repair Kit UX-450-RK

UX-450-PRK

(Kit contains following parts)

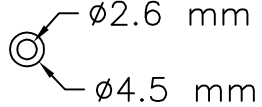
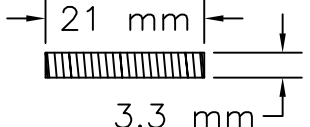
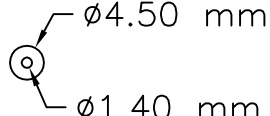
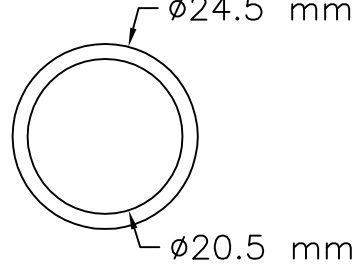
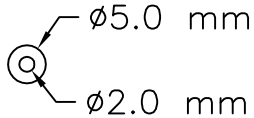
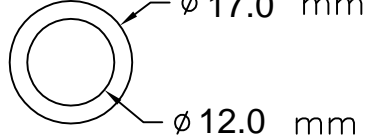
#/#	Bin Location	Part Number	QTY	Description	Material	Drawing / Scketch
1	PA10	944-002-0	2	Support Ring 2.6x4.5x1	Teflon-White	
2	PA1J	976-791-0	2	Spring 3.3 X 21	Spring wire ø.42 mm	
3	PA1A	990-320-0	2	O-Ring 4.5X1.4X1.6	Buna-Black	
4	PA1A	990-329-0	1	O-Ring 24.5X20.5X1.8	Buna-Black	
5	PA1B	990-900-0	1	O-Ring 5x2x1.5	Buna-Black	
6	PA10	992-020-0	1	SU-Ring (Q-12) (NTN)	Buna-Black	

UX-450-RK

(Kit contains following parts)

#/#	Bin Location	Part Number	QTY	Description	Material	Drawing / Scketch
1	PA3A	177-835-6	1	Filter 6x10x25	Filter Element (Yellow)	
2	SEWALL	AM-OIL	1	Oil Air Motor 1 oz. fluid	Plastic Container	<p style="text-align: right;">Scale 1:2</p>
3	PA2B	188-282-8	6	Blade(PC) 7.7x38x1.35	Phenolic-Fiber	
4	PA2I	982-401-0	1	Ball Bearing(EE-2) 6.3x19x5.5	Bearing Steel	
5	PA2I	982-402-0	1	Ball Bearing(EE-3) 9.5x22.2x5.5	Bearing Steel	

UX-450-RK

(Kit contains following parts)

#/#	Bin Location	Part Number	QTY	Description	Material	Drawing / Scketch
6	PA1A	990-337-0	2	O-Ring (JW1530-27) 32x36x1.75	Buna-Black	