

UX-1620 OIL-PULSE TOOLS

EXPLODED VIEW

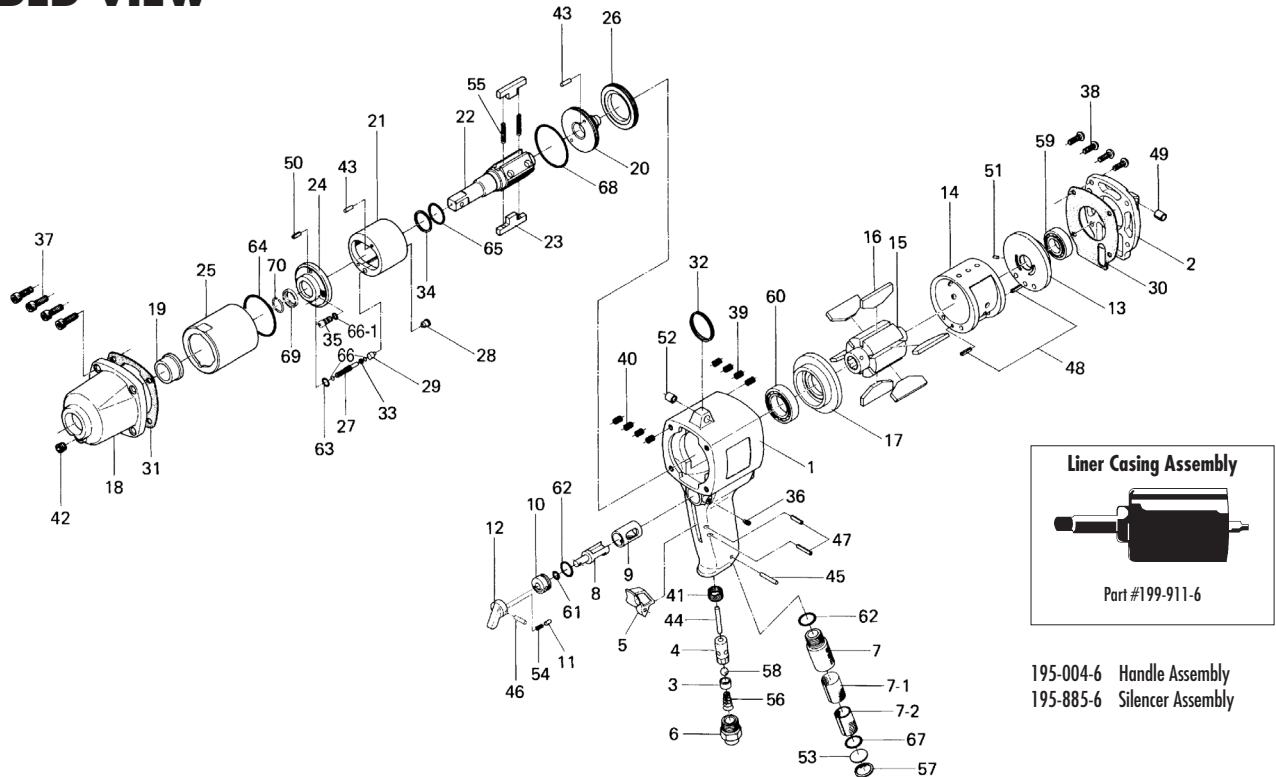

PARTS LIST — FOR REFERENCE ONLY

Index Number	Part Number	Description	Qty.	Index Number	Part Number	Description	Qty.	Index Number	Part Number	Description	Qty.
1	195-025-6	Handle	1	26	195-906-3	Liner Casing Setter	1	50	969-450-0	Pin (G) (3 x 8)	1
2	195-012-3	Head Cover	1	27	195-907-3	Relief Valve Spindle	1	51	973-066-0	Roll Pin (2.5 x 6)	1
3	188-100-1	Valve	1	28	195-969-6	Relief Valve Plug	1	52	973-361-0	Roll Pin (8 x 12)	1
4	063-102-3	Valve Bushing	1	29	195-970-3	Relief Valve	1	53	975-600-0	Spacer (20 x 1)	1
5	026-107-7	Valve Lever	1	30	195-853-3	Head Cover Packing	1	54	976-025-0	Spring (3 x 8.5)	1
6	195-091-3	Air Inlet Bushing	1	31	195-867-3	Front Casing Packing	1	55	976-795-0	Spring (4.3 x 40.5) (0.6) (WPC)	2 ●
7	195-780-9	Exhaust Stack	1	32	004-790-2	Suspension Ring	1	56	977-180-0	Cone Spring (7.5 x 12 x 22)	1
7-1	195-042-9	Silencer	1	33	944-003-0	Supporter Ring (3 x 5 x 1)	2 ●	57	979-320-0	Inner Snap Ring (IRTW-20)	1
7-2	195-835-6	Filter	1	34	944-225-0	Supporter Ring (25.2 x 29.4 x 1.5)	1 ●	58	981-208-0	Ball (5/16)	1
8	189-210-8	Reverse Valve	1	35	194-742-3	Oil Plug	1	59	982-103-0	Ball Bearing (6003)	1
9	189-211-8	Reverse Valve Bushing	1	36	952-108-0	Allen Head Dog Point Screw (M4 x 8)	1	60	982-906-0	Ball Bearing (6905)	1
10	187-222-1	Reverse Valve Setter	1	37	945-220-0	Allen Head Bolt (M6 x 20)	4	61	990-205-0	O-Ring (JW1516-5)	1
11	054-220-1	Reverse Lever Notch	1	38	940-954-0	Hexagon Round Head Bolt (M5 x 16)	4	62	990-914-0	O-Ring (SNS-16)	2
12	023-212-4	Reverse Lever	1	39	965-011-0	Heli-Sert (M5 x 1.5D)	4	63	990-974-0	O-Ring (SNS-6) (NOK)	1 ●
13	189-285-4	Rear Plate	1	40	965-021-0	Heli-Sert (M6 x 1.5D)	4	64	990-937-0	O-Ring (SNS-46)	1 ●
14	195-286-6	Cylinder	1	41	965-118-0	Heli-Sert (M18 x 1.5 x 1D)	1	65	990-170-0	O-Ring (ARPS68-120) NTN	1 ●
15	195-287-6	Rotor	1	42	966-100-0	Allen Head Plug (1/8)	1	66	990-971-0	O-Ring (SNS-3) (NOK)	2 ●
16	195-288-6	Blade	6	43	970-206-0	Pin (H) (3 x 8)	4	66-1	990-970-0	O-Ring (SNS-2) (NOK)	1 ●
17	189-289-4	Front Plate	1	44	970-337-0	Pin (H) (4 x 36)	1	67	990-916-0	O-Ring (SNS-18)	1
18	199-439-6	Front Casing	1	45	971-163-0	Pin (2.5 x 23)	1	68	990-936-0	O-Ring (SNS-45)	1 ●
19	195-328-7	Anvil Bushing	1	46	973-016-0	Roll Pin (2 x 16)	1	69	975-242-0	Spacer	1
20	195-901-3	Rear Liner Plate	1	47	973-118-0	Roll Pin (3 x 18)	2	70	978-328-0	Snap Ring	1
21	195-902-6	Liner	1	48	973-214-0	Roll Pin (4 x 14)	2				
22	199-319-6	Anvil (3/4 SQ)	1	49	973-360-0	Roll Pin (8 x 10)	1				
23	195-440-6	Driving Blade	2								
24	199-904-6	Front Liner Plate	1								
25	195-905-6	Liner Casing	1								

ACCESSORIES

75	939-104-0	Allen Wrench (5 mm)	1
76	939-109-0	Allen Wrench (2 mm)	1

FOOTNOTES

● = Items in Pulse Repair Kit UX-1620-PRK



10000 SE PINE
PORTLAND, OR 97216
503-254-6600
FAX 503-255-2615

When ordering spare parts, please specify
tool type, part number, and description.

UX-1620-PRK

(Kit contains following parts)

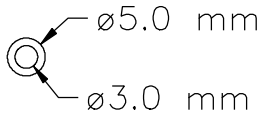
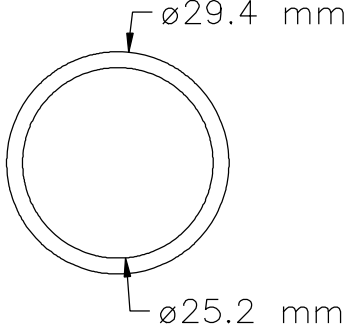
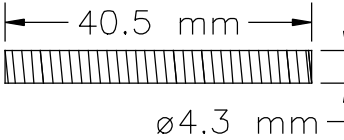
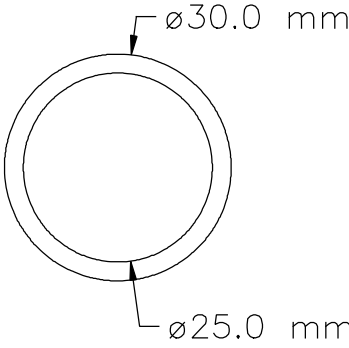
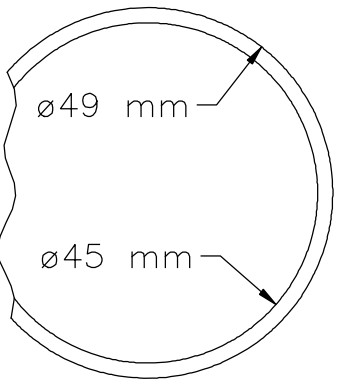
#/#	Bin Location	Part Number	QTY	Description	Material	Drawing / Scketch
1	PA10	944-003-0	2	Support Ring 3.0x5.0x1	Teflon-White	
2	PA10	944-225-0	1	Supporting Ring 25.2x29.4x1.5	Teflon-White	
3	PA1J	976-795-0	2	Spring 4.3x40.5 (0.6) WPC	Spring wire ø.60 mm	
4	PA1A	990-170-0	1	O-Ring (ARP568-120)(NTN) 25x30x2.7	Buna-Black	
5	PA1B	990-936-0	1	O-Ring (SNS-45) 45x49x2	Buna-Black	

UX-1620-PRK

(Kit contains following parts)

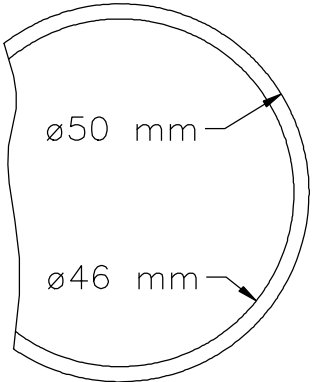
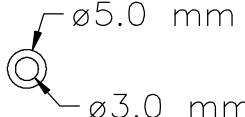
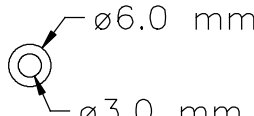
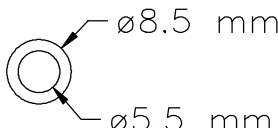
#/#	Bin Location	Part Number	QTY	Description	Material	Drawing / Scketch
6	PA1B	990-937-0	1	O-Ring (SNS-46) 46x50x2	Buna-Black	 <p>ø50 mm ø46 mm</p>
7	PA1C	990-970-0	1	O-Ring (SNS-2)	Buna-Black	 <p>ø5.0 mm ø3.0 mm</p>
8	PA1C	990-971-0	2	O-Ring (SNS-3) (NOK)	Buna-Black	 <p>ø6.0 mm ø3.0 mm</p>
9	PA1C	990-974-0	1	O-Ring (SNS-6) (NOK)	Buna-Black	 <p>ø8.5 mm ø5.5 mm</p>