

UL-80 SERIES OIL-PULSE WRENCHES

EXPLODED VIEW

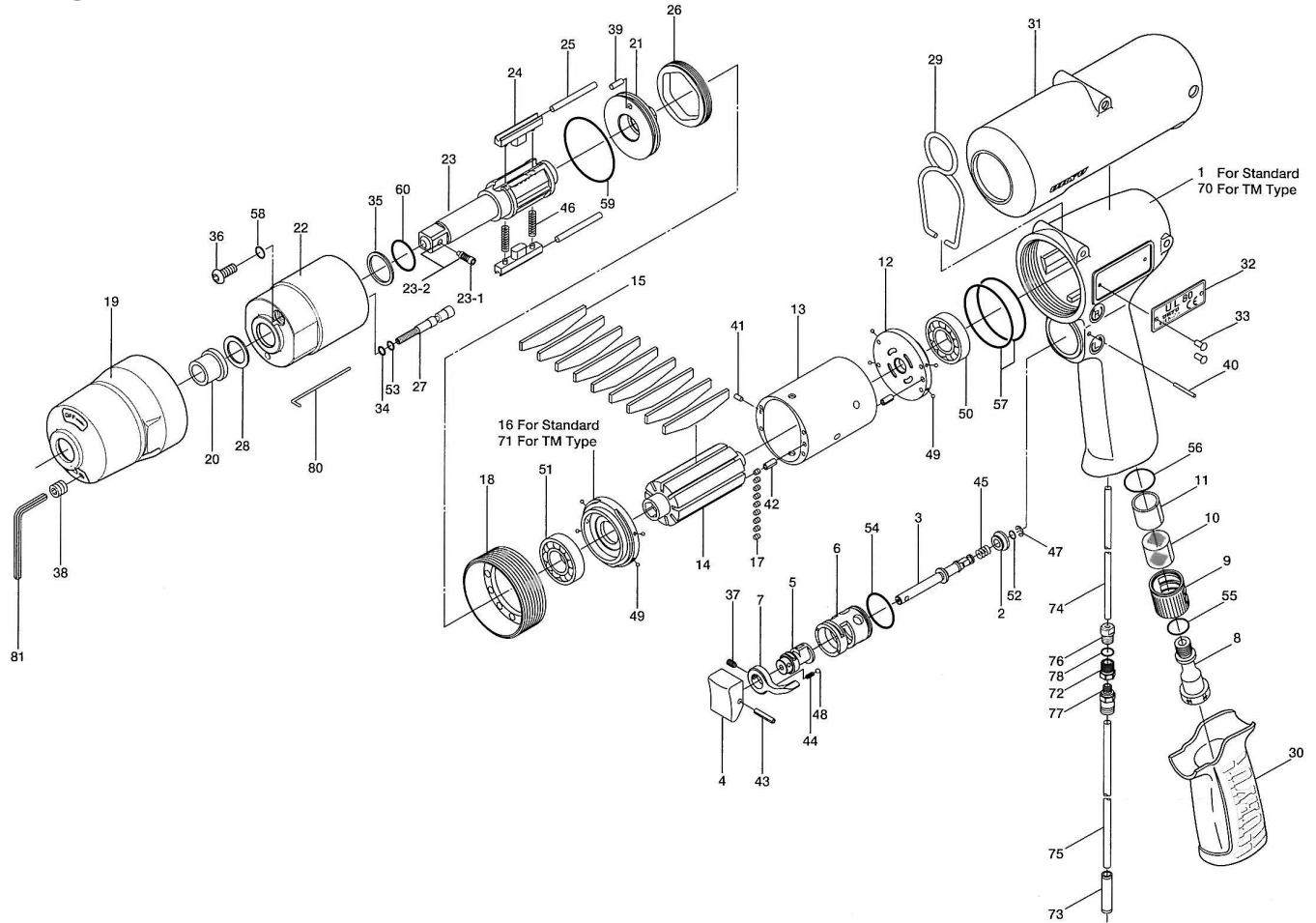

PARTS LIST — FOR REFERENCE ONLY

| Index Number | Part Number | Description | Qty. | Index Number | Part Number | Description | Qty. | Index Number | Part Number | Description | Qty. |
|--------------|-------------|------------------------------|------|--------------|-------------|---------------------------------|------|----------------------------|-------------|----------------------------|------|
| 1 | 117-025-2 | Handle | 1 | 24 | 115-440-3 | Driving Blade | 2 | 49 | 981-045-0 | Ball (1.5 mm) | 8 |
| 2 | 147-100-3 | Valve | 1 | 25 | 147-974-8 | Roller Pin (2.5 x 30) | 2 | 50 | 982-902-0 | Ball Bearing (6901) | 1 |
| 3 | 147-104-2 | Valve Rod | 1 | 26 | 115-906-3 | Liner Casing Cover | 1 | 51 | 982-903-0 | Ball Bearing (6902) | 1 |
| 4 | 147-107-2 | Valve Lever | 1 | 27 | 143-970-9 | Relief Valve | 1 | 52 | 990-306-0 | O Ring (ARP-568) | 1 |
| 5 | 147-210-2 | Reverse Valve | 1 | 28 | 178-327-0 | Anvil Front Spacer | 1 | 53 | 990-970-0 | O Ring (SNS-2) | 1 ● |
| 6 | 147-211-2 | Reverse Valve Bushing | 1 | 29 | 174-790-0 | Suspension Ring | 1 | 54 | 990-912-0 | O Ring (SNS-14) | 1 |
| 7 | 480-212-8 | Reverse Lever | 1 | 30 | 147-842-2 | Handle Cover | 1 | 55 | 990-914-0 | ORing (SNS-16) | 1 |
| 8 | 147-091-2 | Air Inlet Bushing | 1 | 31 | 117-840-2 | Casing Cover | 1 | 56 | 990-916-0 | O Ring (SNS-18) | 1 |
| 9 | 147-780-3 | Exhaust Stack | 1 | 32 | 117-924-2 | Name Plate | 1 | 57 | 990-930-0 | O Ring (SNS-40) | 2 |
| 10 | 147-042-2 | Silencer | 1 | 33 | 930-205-0 | Driver Rivet (No.0 x 2.6) | 2 | 58 | 990-971-0 | O Ring (SNS-3) | 1 ● |
| 11 | 147-835-3 | Filter (K200) | 1 | 34 | 944-002-0 | Supporting Ring (2.6 x 4.5 x 1) | 1 ● | 59 | 990-981-0 | O Ring (SNS-29) | 1 ● |
| 12 | 117-285-2 | Rear Plate | 1 | 35 | 944-212-0 | Supporting Ring (12 x 16 x 1.5) | 1 ● | 60 | 992-020-0 | SURing (Q-12) | 1 ● |
| 13 | 117-286-2 | Cylinder | 1 | 36 | 945-942-0 | Hexagon Head Bolt (M4 x 6) | 1 | PARTS FOR (TM) TYPE | | | |
| 14 | 115-287-3 | Rotor | 1 | 37 | 952-106-0 | Hexagon Head Screw (M4 x 6) | 1 | 70 | 852-547-1 | Handle (TM) | 1 |
| 15 | 115-288-3 | Blade | 9 | 38 | 966-099-0 | Allen Head Plug (NPT1/16) | 1 | 71 | 852-548-1 | Front Plate (TM) | 1 |
| 16 | 115-289-3 | Front Plate | 1 | 39 | 970-204-0 | Pin (H) (3x6) | 1 | 72 | 909-442-0 | Connecting Screw | 1 |
| 17 | 147-064-6 | Plug | 9 | 40 | 971-123-0 | Pin (2 x 23) | 1 | 73 | 850-610-1 | Quick Exhaust Connector | 1 |
| 18 | 115-036-3 | Hammer Casing Connector | 1 | 41 | 973-006-0 | Roll Pin (2 x 6) | 1 | 74 | 935-240-0 | Polyurethane Hose | 1 |
| 19 | 115-439-3 | Front Casing | 1 | 42 | 973-008-0 | Roll Pin (2 x 8) | 2 | 75 | 935-350-0 | Polyurethane Hose (F-1504) | 1 |
| 20 | 190-328-6 | Anvil Bushing | 1 | 43 | 973-014-0 | Roll Pin (2 x 14) | 1 | ACCESSORIES | | | |
| 21 | 117-901-2 | Rear Liner Plate | 1 | 44 | 976-006-0 | Spring (3 x 5) | 1 | 80 | 939-091-0 | Allen Wrench (1.5) | 1 |
| 22 | 117-902-2 | Liner | 1 | 45 | 976-457-0 | Spring (7 x 12) | 1 | 81 | 939-105-0 | Allen Wrench (4) | 1 |
| 23 | 117-319-2 | Anvil | 1 | 46 | 976-811-0 | Spring (3.7 x 31) | 2 ● | | | | |
| 23-1 | 891-300-0 | Socket Retainer Pin Assembly | 1 | 47 | 979-405-0 | Outer Snap Ring (E2.5) | 1 | | | | |
| 23-2 | 891-567-1 | Anvil Assembly (P) | 1 | 48 | 981-002-0 | Ball (1/8) | 1 | | | | |



10000 SE PINE
PORTLAND, OR 97216
503-254-6600
FAX 503-255-2615

When ordering spare parts, please specify
tool type, part number, and description.

FOOTNOTES

● = Parts in Pulse Repair Kit UL-80-PRK

UL-80-PRK

(Kit contains following parts)

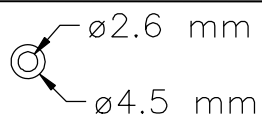
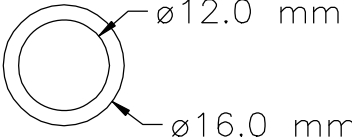
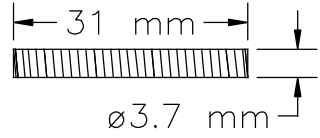
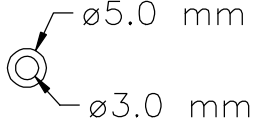
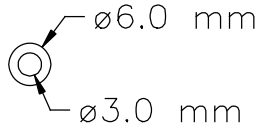
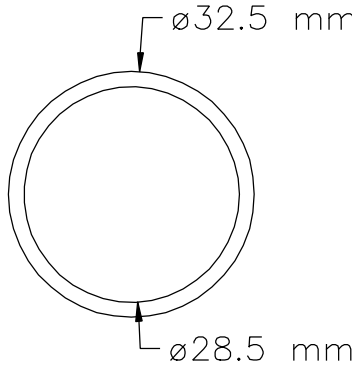
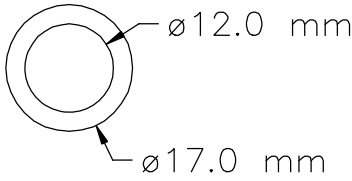
| #/# | Bin Location | Part Number | QTY | Description | Material | Drawing / Scketch |
|-----|--------------|-------------|-----|---------------------------------------|------------------------|---|
| 1 | PA10 | 944-002-0 | 1 | Support Ring 2.6x4.5x1 | Teflon-White |  |
| 2 | PA10 | 944-212-0 | 1 | Supporting Ring 12x16x1.5 | Teflon-White |  |
| 3 | PA6Q | 976-811-0 | 2 | Spring 3.7x31 | Spring wire ø.50 mm |  |
| 4 | PA1C | 990-970-0 | 1 | O-Ring (SNS-2) | Buna-Black |  |
| 5 | PA1C | 990-971-0 | 1 | O-Ring (SNS-3) (NOK) | Buna-Black |  |
| 6 | PA7A | 990-981-0 | 1 | O-Ring SNS-29 (NOK) 28.5x32.5x2 | Buna-Black |  |
| 7 | PA10 | 992-020-0 | 1 | SU-Ring (Q-12) (NTN) | Buna-Black |  |