

UL-70 SERIES OIL-PULSE WRENCHES

EXPLODED VIEW

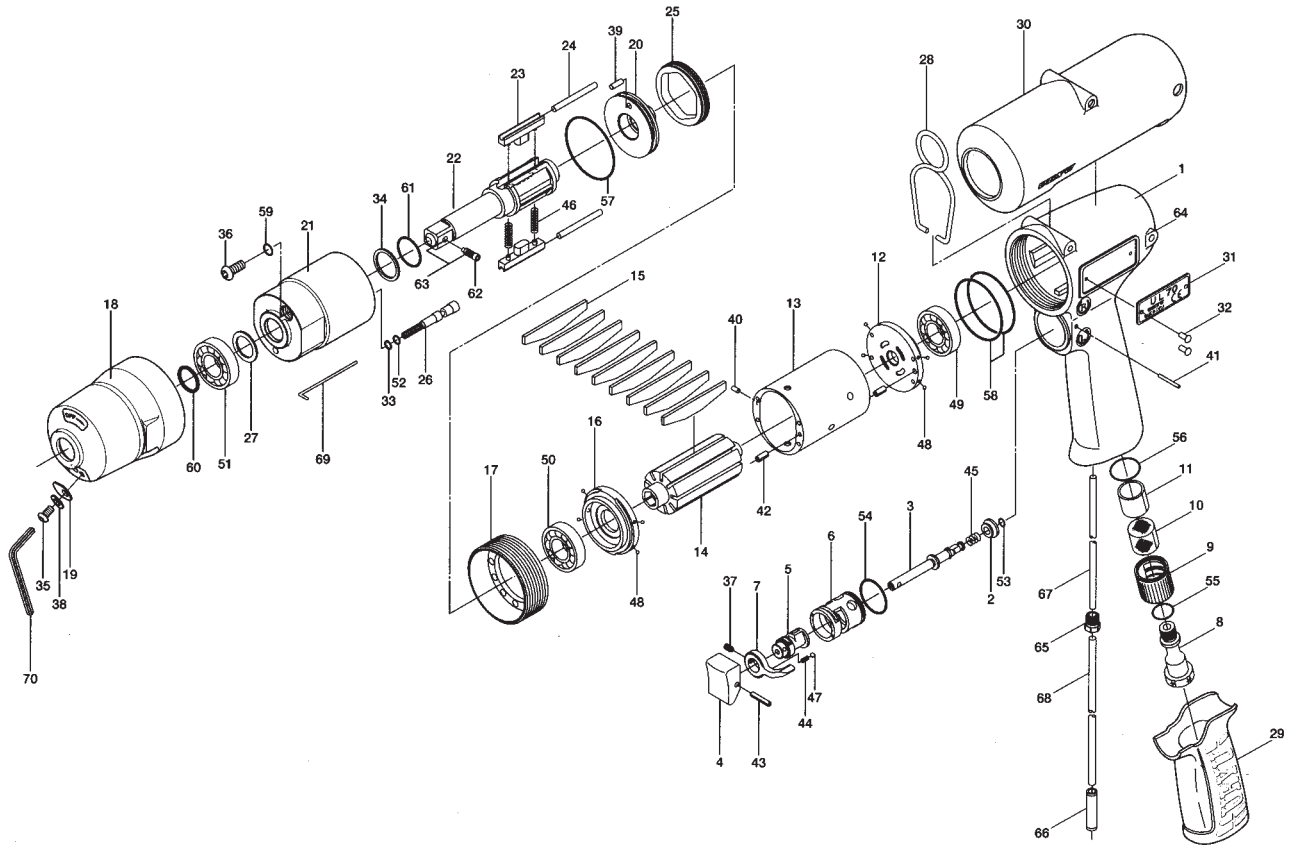

PARTS LIST — FOR REFERENCE ONLY

Index Number	Part Number	Description	Qty.	Index Number	Part Number	Description	Qty.	Index Number	Part Number	Description	Qty.
1	143-025-5	Handle	1	28	143-790-3	Suspension Ball	1	51	982-922-0	Ball Bearing (6901ZZ)	1
2	147-100-3	Valve	1	29	147-842-2	Handle Cover	1	52	990-320-0	O-Ring (ARPS68-003)	1 ●
3	147-104-2	Valve Rod	1	30	143-840-8	Casing Protector	1	53	990-306-0	O-Ring (ARPS68-004)(H)	1
4	147-107-2	Valve Lever	1	31	143-924-8	Metal Tag	1	54	990-912-0	O-Ring (SNS-14)	1
5	147-210-2	Reverse Valve	1	32	930-205-0	Screw (No.0 x 2.6)	2	55	990-914-0	O-Ring (SNS-16)	1
6	147-211-2	Reverse Valve Bushing	1	33	944-001-0	Supporting Ring (2.1 x 4 x 1)	1 ●	56	990-916-0	O-Ring (SNS-18)	1
7	480-212-8	Reverse Lever	1	34	944-212-0	Supporting Ring (12 x 16x1.5)	1 ●	57	990-917-0	O-Ring (SNS-24)	1 ●
8	147-091-2	Air Inlet Bushing	1	35	945-935-0	Hexagon Round Head Bolt (M3 x 6)	1	58	990-929-0	O-Ring (SNS-36)	2 ■
9	147-780-3	Exhaust Stack	1	36	945-942-0	Hexagon Round Head Bolt (M4 x 6)	1	59	990-971-0	O-Ring (SNS-3) (NOK)	1 ●
10	147-042-2	Silencer	1	37	952-106-0	Allen Head Dog Point Screw (M4 x 6)	1	60	993-100-0	Rubber Sponge Ring (12 x 16.5 x 2)	1
11	147-835-3	Filter (K200)	1 ■	38	961-030-0	Flat Washer (3 mm)	1	61	992-020-0	Su-Ring (Q12) (NTN)	1 ●
12	143-285-8	Rear Plate	1	39	970-147-0	Pin (H) (2.5 x 5)	1	62	891-300-1	Socket Pin Assembly (3/8)	1
13	143-286-8	Cylinder	1	40	971-102-0	Pin (2 x 3.8)	1	63	891-553-1	Anvil (OP-P)	1
14	143-287-8	Rotor	1	41	971-123-0	Pin (2 x 23)	1	PARTS FOR (TM)-TYPE			
15	147-288-6	Blade (PC)	9 ■	42	973-008-0	Roll Pin (2 x 8)	2	64	852-525-1	Handle	1
16	143-289-8	Front Plate	1	43	973-014-0	Roll Pin (2 x 14)	1	65	850-610-1	Connecting Screw	1
17	143-036-8	Hammer Casing Connector	1	44	976-006-0	Spring (3 x 5)	1	66	933-250-0	One-Touch Connector (SLS-04)	1
18	143-439-8	Front Casing	1	45	976-457-0	Spring (7 x 12) (0.9)	1	67	935-240-0	Nylon Tube (18NY)	1
19	143-243-8	Regulator Valve Cover	1	46	976-788-0	Spring 3.5 x 25 (0.45) WPC	2 ●	68	935-350-0	Polyurethane Hose (F1504)	1
20	143-901-8	Rear Liner Plate	1	46-1	979-405-0	Outer Snap Ring (E25)	1	ACCESSORIES			
21	143-902-7	Liner	1	47	981-002-0	Ball (1/8)	1	69	939-091-0	Allen Wrench (1.5 mm)	1
22	143-319-8	Anvil (OP-0)	1	48	981-045-0	Ball (1.5)	8	70	939-107-0	Allen Wrench (2 mm)	1
23	147-440-6	Driving Blade	2	49	982-014-0	Ball Bearing (607)	1 ■				
24	147-974-6	Roller Pin (2.5 x 28)	2	50	982-902-0	Ball Bearing (6901)	1 ■				
25	143-906-8	Liner Casing Cover	1								
26	143-970-7	Relief Valve	1								
27	178-327-0	Anvil Front Spacer	1								



10000 SE PINE
PORTLAND, OR 97216
503-254-6600
FAX 503-255-2615

When ordering spare parts, please specify tool type, part number, and description.

FOOTNOTES

- = Items in Pulse Repair Kit UL-70-PRK
- = Items in Repair Kit UL-70-RK

UL-70-PRK

(Kit contains following parts)

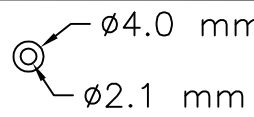
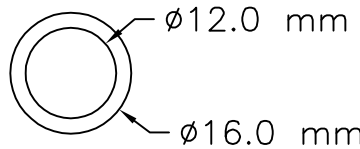
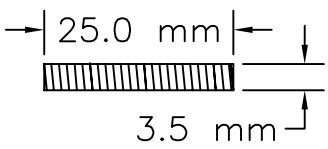
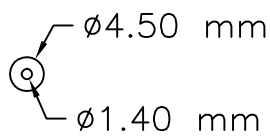
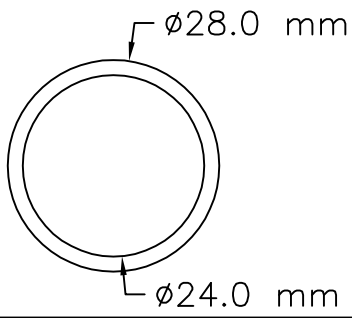
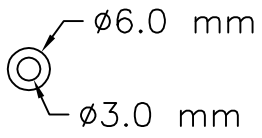
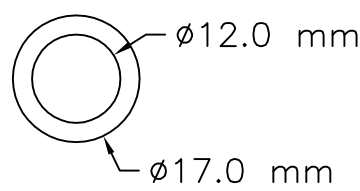
#/#	Bin Location	Part Number	QTY	Description	Material	Drawing / Scketch
1	PA10	944-001-0	1	Support Ring 2.1x4x1	Teflon-White	
2	PA10	944-212-0	1	Supporting Ring 12x16x1.5	Teflon-White	
3	PA1J	976-788-0	2	Spring 3.5 X 25	Spring wire ø.45 mm	
4	PA1A	990-320-0	1	O-Ring 4.5X1.4X1.6	Buna-Black	
5	PA1B	990-917-0	1	O-Ring (SNS-24) 24x28x2	Buna-Black	
6	PA1C	990-971-0	1	O-Ring (SNS-3) (NOK)	Buna-Black	
7	PA10	992-020-0	1	SU-Ring (Q-12) (NTN)	Buna-Black	

UL-70-RK

(Kit contains following parts)

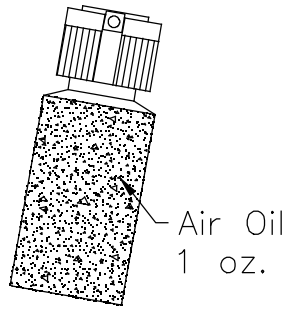
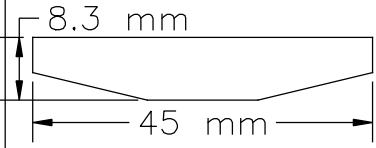
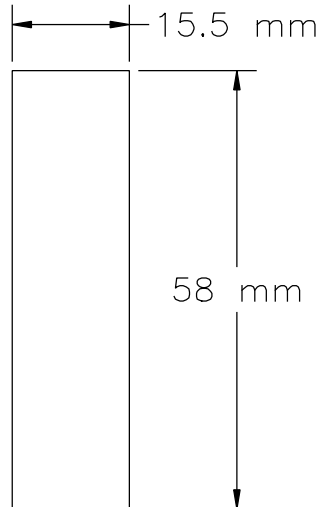
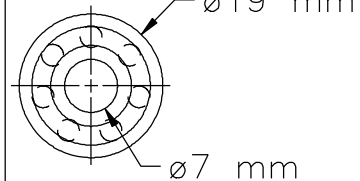
#/#	Bin Location	Part Number	QTY	Description	Material	Drawing / Scketch
1	SEWALL	AM-OIL	1	Oil Air Motor 1 oz. fluid	Plastic Container	
2	PA2B	147-288-6	9	Blade(PC) 8.3x45x1.65	Phenolic-Fiber	
3	PA3A	147-835-3	1	Filter K200 15.5x58x1.65	Sendered Plastic	
4	PA2H	982-014-0	1	Ball Bearing(607) 7x19x6	Bearing Steel	

UL-70-RK

(Kit contains following parts)

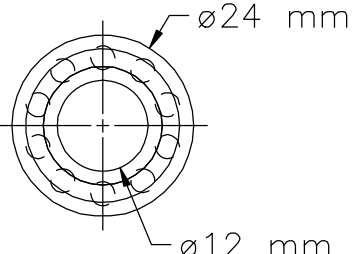
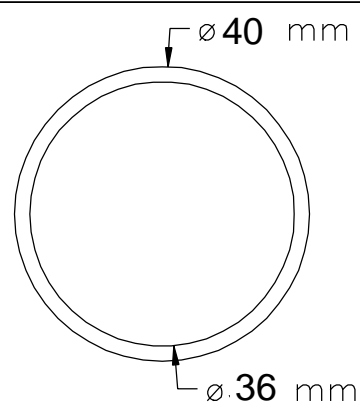
#/#	Bin Location	Part Number	QTY	Description	Material	Drawing / Scketch
5	PA2I	982-902-0	1	Ball Bearing(6901) 12x24x6	Bearing Steel	 <p>Technical drawing of a ball bearing (6901) showing an outer diameter of 24 mm and an inner diameter of 12 mm.</p>
6	PA1B	991-929-0	2	O-Ring (SNS-36) 36 x 40 x 2	Buna-Black	 <p>Technical drawing of an O-ring (SNS-36) showing an outer diameter of 40 mm and an inner diameter of 36 mm.</p>