



# Gen IV iEC Controller Operation Manual



# Table of Contents

<b>1. Safety Information</b>	<b>3</b>	4.5.10 Master Spindle Setup	46
<b>2. Controller Diagram</b>	<b>4</b>	4.5.10.1 Setting up Multi-Spindle Network	46
<b>2.1 Bottom Panel</b>	<b>4</b>	4.5.11 Languages	46
<b>2.2 Front Console LED Display</b>	<b>4</b>	<b>4.6 Tool</b>	<b>48</b>
<b>3. Initial Setup</b>	<b>5</b>	4.6.1 Tool Setup	48
<b>3.1 Connecting to the Controller</b>	<b>5</b>	4.6.2 Service Log	48
<b>3.2 Quick Set Up (Default PSets from Tool)</b>	<b>7</b>	4.6.3 Button Calibration	48
<b>4. Home Page (Main Menu)</b>	<b>8</b>	4.6.4 Torque Calibration	49
<b>4.1 Run</b>	<b>8</b>	4.6.5 Torque Calibration Routine	49
<b>4.2 PSet</b>	<b>10</b>	4.6.6 TID Parameters	49
4.2.1 Add New PSet	10	4.6.7 TID Memory	50
4.2.1.1 Add New Stage	10	<b>4.7 Accessories</b>	<b>50</b>
4.2.1.2 AcraDrive Discontinuous Drive Mode Settings	11	<b>4.8 Diagnostics</b>	<b>50</b>
4.2.2 PSet Stages	14	4.8.1 Controller Overview	50
4.2.2.1 TC Torque Control Stage	14	4.8.2 Controller Status	51
4.2.2.2 TC_AM Torque Control Angle Monitor Stage	15	4.8.3 Tool Overview	51
4.2.2.3 AC_TM Angle Control Torque Monitor Stage	16	4.8.4 Live Tool	52
4.2.2.4 TC_AC Torque Control Angle Control Stage	17	4.8.5 Indicators	52
4.2.2.5 Yield Control Stage	18	4.8.6 Identify Controller	52
4.2.2.6 Delay Stage	19	4.8.7 Record Logs	52
4.2.2.7 Unfasten Stage	19	4.8.7.1 Change Log	52
4.2.2.8 Ergo Stop Stage	20	4.8.7.2 Information Log	52
4.2.2.9 Brake Stop Stage	20	4.8.7.3 Error Log	52
4.2.2.10 AC_TA Angle Control Torque Averaging Stage	21	4.8.7.4 All	52
4.2.2.11 AC_TCOMP Angle Control Torque Compensation Stage	22	4.8.8 System Status	52
4.2.2.12 AC_TCOMP Display of Torque Compensation Value	22	4.8.9 I/O Diagnostics	53
4.2.2.13 Sync Stage	23	4.8.10 Network Diagnostics	53
4.2.2.14 Thread Forming Stage	23	4.8.11 Extended Logging	53
4.2.2.15 Homing Stage	24	<b>4.9 Login</b>	<b>53</b>
4.2.2.16 AC_TM Anti-Necking Stage	25	<b>4.10 Advanced</b>	<b>54</b>
4.2.3 Edit PSet	26	4.10.1 Login Setup	54
4.2.4 Advanced Options	26	4.10.2 Results Archive	54
4.2.5 Default Psets	27	4.10.3 Import Settings	55
4.2.6 Manage PSets	27	4.10.4 Export Controller	55
4.2.7 Multifstage Rundown Evaluation and Reporting	28	4.10.5 Update Controller	55
4.2.8 Multiple Stage Rundown Examples	29	4.10.6 Backup Restore	56
<b>4.3 Job</b>	<b>30</b>	4.10.7 Restore Factory Defaults	56
4.3.1 Add New Job	30	4.10.8 Previous Software	57
4.3.1.1 Advanced Options	30	4.10.9 Calibrate Touch Screen	57
4.3.2 Jobs "Enabled" Display and Button Function	31	4.10.10 Soft Reboot	57
<b>4.4 Results</b>	<b>31</b>	<b>4.11 Statistics</b>	<b>57</b>
4.4.1 Saving Rundown(s)	32	<b>5. Barcode Reader Details</b>	<b>58</b>
<b>4.5 Controller</b>	<b>33</b>	<b>6. Glossary of Terms</b>	<b>60</b>
4.5.1 Tool Setup	33	<b>7. Icons Defined</b>	<b>61</b>
4.5.1.1 Lock Tool On Reject	33	<b>8. Stop Codes</b>	<b>62</b>
4.5.1.2 Buzzer	34	<b>9. Error Codes</b>	<b>63</b>
4.5.1.3 Headlight	34	<b>10. Dual-Lever Tools Requiring Two-Handed Operation</b>	<b>65</b>
4.5.1.4 Start Input	34	<b>11. 24 Volt I/O</b>	<b>66</b>
4.5.1.5 MFB (Multi-Function Button)	35	<b>12. Assignable I/O</b>	<b>68</b>
4.5.1.6 Disassembly	36	<b>13. Controller Supported MIDs</b>	<b>80</b>
4.5.1.7 Tubenut	37	<b>14. Dimensions</b>	<b>81</b>
4.5.1.8 Past Due Service Calibration	37	<b>15. Specifications</b>	<b>81</b>
4.5.2 IO	38	<b>16. Tubenut Tool Setup Details</b>	<b>82</b>
4.5.2.1 Physical IO	38	<b>16.1 Overview</b>	<b>82</b>
4.5.2.2 Physical IO Monitor	38	<b>16.2 Tubenut Homing</b>	<b>82</b>
4.5.2.3 Anybus/Modbus TCP/Ethernet IP Inputs	39	16.2.1 Tubenut Home TID parameters	82
4.5.2.4 Anybus/Modbus TCP/Ethernet IP Outputs	40	<b>16.3 Setting the Tool's Tubenut Home TID Parameters</b>	<b>82</b>
4.5.3 Communication Interfaces	41	<b>16.4 Controller Parameters Affecting Tubenut Homing</b>	<b>82</b>
4.5.3.1 Ethernet/Second Ethernet	41	<b>16.5 Tubenut Pinch Detection</b>	<b>83</b>
4.5.3.2 System Port	41	16.5.1 Obstruction Detection TID Parameters	83
4.5.3.3 Serial Port	41	16.5.2 Setting the Tool's Tubenut Obstruction Detection	83
4.5.3.4 Anybus	42	16.5.3 Controller Parameters Affecting Tubenut Pinch Detection	83
4.5.3.5 Spindle USB Port	42	16.5.4 Tubenut Homing Start Input Logic Selection	83
4.5.3.6 Serial USB	44	<b>17. Troubleshooting</b>	<b>84</b>
4.5.4 Protocols	44	<b>18. AIMCO Warranty</b>	<b>85</b>
4.5.5 Front Panel Buttons	44		
4.5.6 Power Up	44		
4.5.7 Bar Code Setup	45		
4.5.8 Set Time	46		
4.5.9 Remote Connections	46		

## 1. Safety Information

### General Power Tool Safety Warnings



#### WARNING

Read all safety warnings, instructions, illustrations, and specifications provided with this power tool. Failure to follow all instructions listed below may result in electric shock, fire, and/or serious injury.

Save all warnings and instructions for future reference.

#### 1. Work area safety

- a. Keep work area clean and well lit.
- b. Do not operate power tools in explosive atmospheres, such as in the presence of flammable liquids, gases, or dust.
- c. Keep children and bystanders away while operating a power tool.

#### 2. Electrical safety

- a. Power tool plugs must match the outlet. Never modify the plug in any way. Do not use any adapter plugs with earthed (grounded) power tools.
- b. Avoid body contact with earthed or grounded surfaces, such as pipes, radiators, ranges, and refrigerators.
- c. Do not expose power tools to rain or wet conditions.
- d. Do not abuse the cord. Never use the cord for carrying, pulling, or unplugging the power tool. Keep cord away from heat, oil, sharp edges, or moving parts.
- e. When operating a power tool outdoors, use an extension cord suitable for outdoor use.
- f. If operating a power tool in a damp location is unavoidable, use a residual current device (RCD) protected supply.

#### 3. Personal safety

- a. Stay alert, watch what you are doing, and use common sense when operating a power tool. Do not use a power tool while you are tired or under the influence of drugs, alcohol, or medication.
- b. Use personal protective equipment. Always wear eye protection.
- c. Prevent unintentional starting. Ensure the switch is in the off-position before connecting to power source and/or battery pack, picking up or carrying the tool.
- d. Remove any adjusting key or wrench before turning the power tool on.
- e. Do not overreach. Keep proper footing and balance at all times.
- f. Dress properly. Do not wear loose clothing or jewelry. Keep your hair, clothing, and gloves away from moving parts.
- g. Do not let familiarity gained from frequent use of tools allow you to become complacent and ignore tool safety principles. A careless action can cause severe injury within a fraction of a second.

#### 4. Power tool use and care

- a. Do not force the power tool. Use the correct power tool for your application.
- b. Do not use the power tool if the switch does not turn it on and off.
- c. Disconnect the plug from the power source and/or remove the battery pack, if detachable, from the power tool before making any adjustments, changing accessories, or storing power tools. Such preventive safety measures reduce the risk of starting the power tool accidentally.
- d. Store idle power tools out of the reach of children and do not allow persons unfamiliar with the power tool or these instructions to operate the power tool. Power tools are dangerous in the hands of untrained users.
- e. Maintain power tools and accessories. Check for misalignment or binding of moving parts, breakage of parts, and any other condition that may affect the power tool's operation. If damaged, have the power tool repaired before use. Many accidents are caused by poorly maintained power tools.
- f. Use the power tool, accessories, and tool bits, etc., in accordance with these instructions, taking into account the working conditions and the work to be performed. Use of the power tool for operations different from those intended could result in a hazardous situation.
- g. Keep handles and grasping surfaces dry, clean, and free from oil and grease. Slippery handles and grasping surfaces do not allow for safe handling and control of the tool in unexpected situations.

#### 5. Service

- a. Have your power tool serviced by a qualified repair person using only identical replacement parts. This will ensure that the safety of the power tool is maintained.

#### 6. Equipment Installation, Operation, and Maintenance

- a. Safety of any system incorporating the equipment is the responsibility of the system assembler
- b. Position the equipment so that it is easy to access the disconnecting device
- c. Do not replace main power cord with an inadequately rated cord
- d. Only allow your power tool to be repaired by a qualified technician using only original spare parts, available from AIMCO. This ensures that the safety of your device is maintained.

## 2. Controller Diagram

### 2.1 Bottom Panel

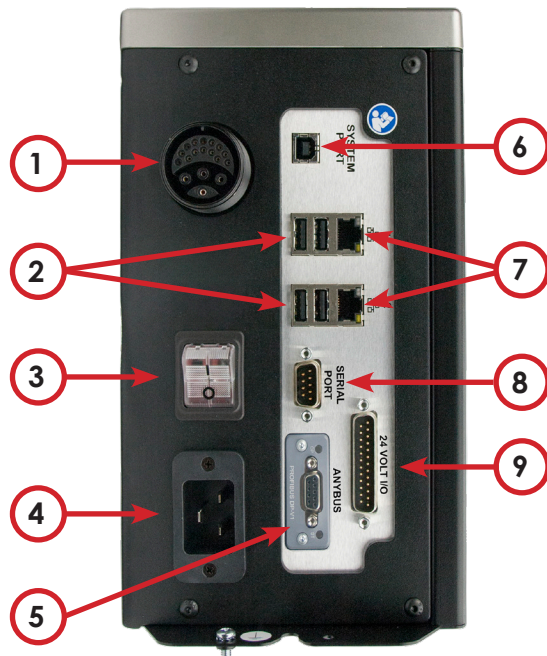

1	Tool Connector (19 pin) - Standard connection point for tool cable
2	USB Port - for import/export of data
3	Power Disconnect Switch - Turns controller on and off
4	Power Cord Connection
5	Anybus - To connect customer's fieldbus network (ex. Profibus)
6	System Port - USB connection used to connect external computer to configure/monitor the controller
7	Ethernet Port RJ45 - Connection used to connect external computer to configure/monitor the controller
8	Serial Port (DB-9 Pin M) - Serial data output for communication with peripherals such as bar code readers
9	24 Volt I/O Connector (DB-25 Pin M) - Input and output of signals for process control

### 2.2 Front Console LED Display

#### Indicator Lights

Green	Indicates fastening cycle meets specified parameters.
Red	Indicates fastening cycle rejected for exceeding high torque.
Red Flashing	Indicates low torque. Fastening cycle was rejected for not achieving low torque.
Yellow	Indicates High Angle. Fastening cycle was rejected for exceeding high angle.
Yellow Flashing	Indicates Low Angle. Fastening cycle was rejected for not achieving low angle.
Blue	Tool is In-cycle, above threshold.



**Toggle Button**  
Toggles what is shown in the secondary display

**Parameter Settings (PSet)/Job Display**

**Increment/Decrement Buttons**  
Change PSet

**Torque Display**  
Always displays torque value

**Secondary Display**  
Toggle button switches secondary display between

- Units of measure
- Ethernet IP address
- USB (System Port) IP address
- COMP: Torque Compensation Tare Value (See details in AC\_TCOMP Stage)
- Angle report

NOTE: If Jobs are enabled refer to "4.3 Job" on page 30 for Toggle Button function.

## 3. Initial Setup

**Step 1:** Connect tool cable to Tool Connector. Cable consists of a male pin set housed in a molded 19 pin connector with a polarizing notch. Align tool cable notch with tool connector notch on the controller and insert cable. Securely thread connector coupler to controller body.

**Step 2:** Repeat above process to connect tool cable to AcraDyne tool being used with the controller.

**Step 3:** Plug female end of power cable into Power Cable Connector.

**Step 4:** Plug male end of power cable into appropriate power source.

\*It is recommended that 5000, 6000, 7000 and 8000 series tools be supplied by 200-240VAC.

Due to a variety of 230Vac power outlets, the standard power cable plug-end provided with the controller may need to be modified in order to connect to local 230Vac power outlets. AcraDyne has a wide variety of country-specific power cord options available. Check with your authorized AcraDyne representative to see if your specific configuration is available. In any case, connection to local power should be made in consultation with a qualified electrician.

**Step 5:** The Redundant Earth Ground (required) must be connected to ground using the #14 AWG conductor, a green wire with a yellow stripe. Attach using a #10-14AWG ring terminal and #10 star washer (Figure 1).



Figure 1 — Redundant Earth Ground Attachment

**Step 6:** Turn controller on by pushing the Power Disconnect Switch to the POWER ON position, a light indicates power on.

### Information

Controller fault (Drive Vbus low)



**NOTE:** Warning will appear if the controller is power cycled too quickly. If fault

appears, Power Down controller, wait a minimum of 10 seconds between controller Power Down and Power Up to clear error and restart controller.

### 3.1 Connecting to the Controller

There are three ways to program/communicate with the controller:

- Controller touch-screen console
- System Port: (USB connection) Direct connection to controller.
- Ethernet Port: Via direct connection or LAN.

#### Touchscreen Console

Controller functions and programming can be accessed directly through the touch-screen.

1. Power on controller.
2. Run screen will appear
3. Controller is ready for use.

#### Connecting via the System Port Directly to PC

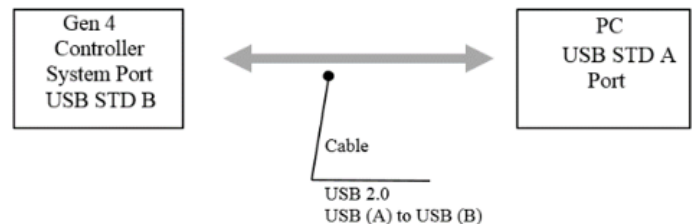

The following is an example using Window 7. Your screen may look different depending on the operating system.

#### Windows USB Setup

**Step 1:** Power on PC and controller, allow enough time for them to become fully operational.

**Step 2:** Attach controller to PC using a USB 2.0 A-B cable. If this is the first time connecting the devices, wait for Windows to install the RNDIS driver. This should happen automatically.

**Step 3:** After the driver is installed, go to 'Control Panel'.

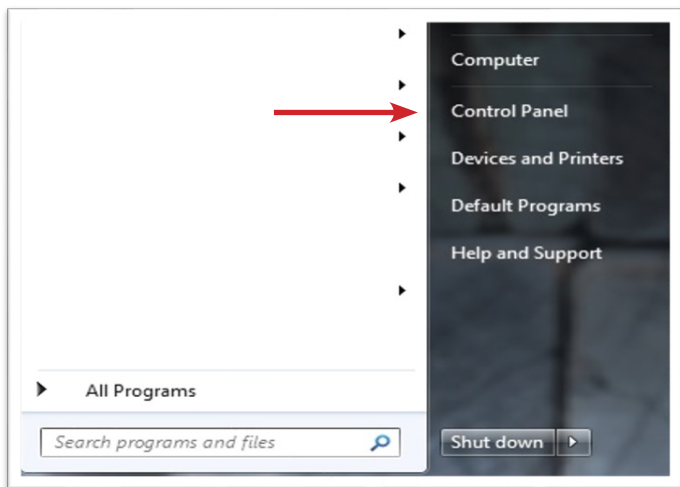

**Step 4:** Go to 'Network and Internet'.

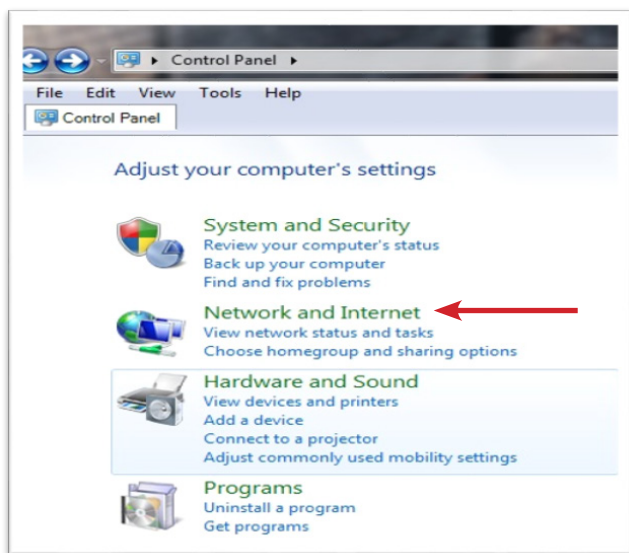

**Step 5:** Go to 'Network and Sharing Center'.

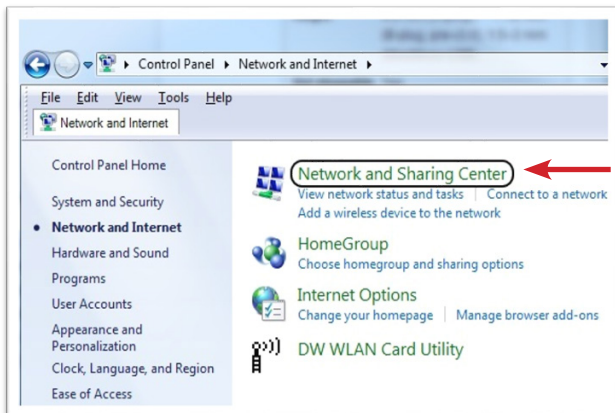

**Step 6:** Go to 'Change adapter settings'.

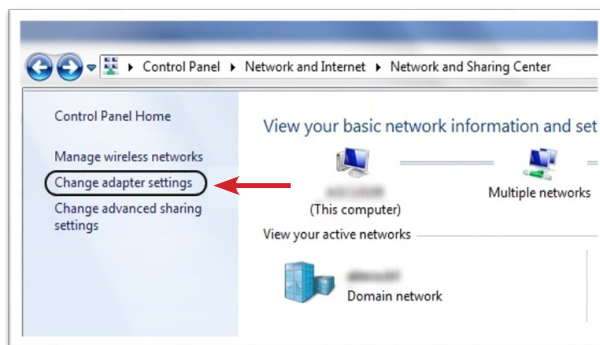

**Step 7:** Find the Local Area Connection that is using the 'USB Ethernet/RNDIS Gadget' network. Right click this network and go to 'Properties'.

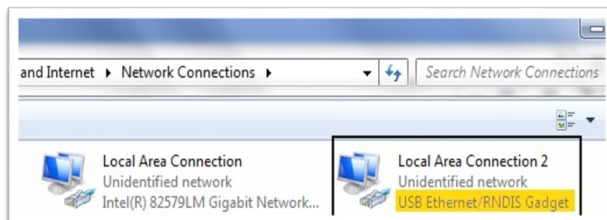

**Step 8:** In Properties window select 'Internet Protocol Version 4' and click 'Properties'.

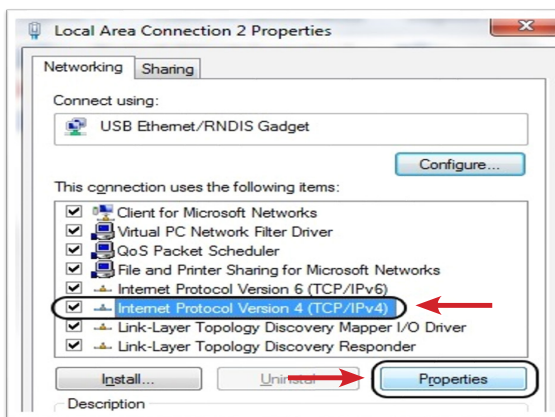

**Step 9:** In 'Properties', set the IP address to a static address.

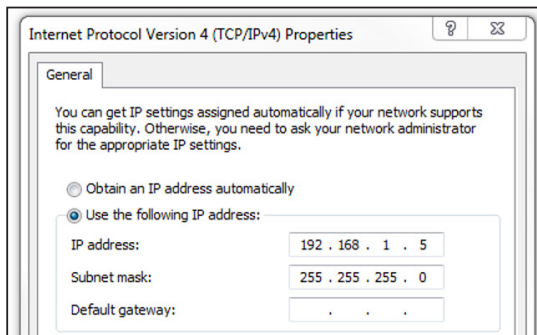

Type an IP address of 192.168.1.5 (Any address on the same subnet as the controller will work). Set subnet mask to 255.255.255.0

**Step 10:** To connect to the controller, open a browser such as Chrome or Firefox. Enter 192.168.1.4, the default system port IP address.

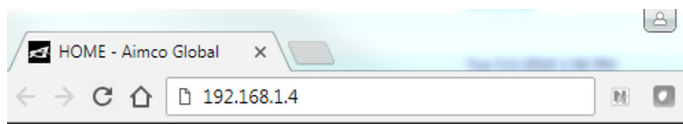

You will see the controller software on your computer screen.



Connecting using the Ethernet Port Directly or via LAN to PC

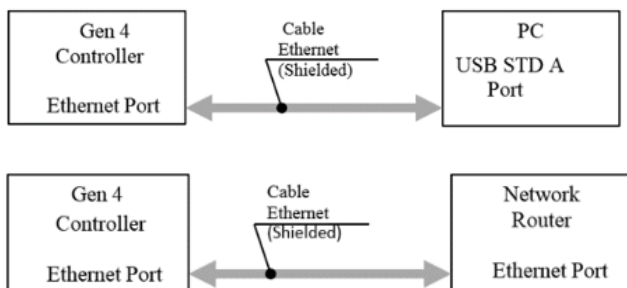

Turn on the computer and make a physical connection by using a straight through Ethernet cable.

Turn on controller. Verify the controller IP address in 'Communication Interfaces' or press toggle button to verify the IP address. If defaulted 0.0.0.0 set desired IP address.

Set a static IP address of the Computer/Laptop to 10.10.30.98 (example) and subnet mask to

255.255.255.0. (For instructions, see the example in "Step 9" earlier in this section.)

To connect to the controller. In the Computer/Laptop open a browser such as Chrome or Firefox. Enter 10.10.30.99, the default Ethernet port IP address.

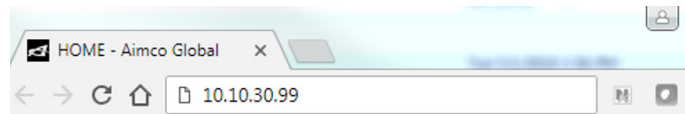

You will see on your computer screen the controller software

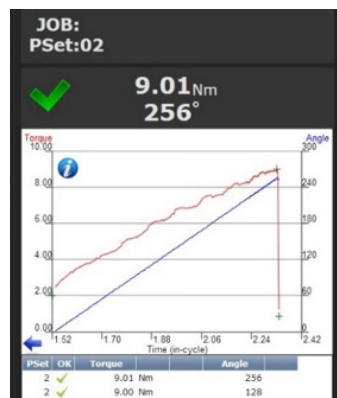

**NOTE:** Controller does not have a DHCP client, it will not automatically configure itself with a usable IP address. Consult your Network Administrator for configuring a correct IP address for your network. The PC, Laptop or Tablet IP address will need to be configured to communicate with the controller.

## 3.2 Quick Set Up (Default PSets from Tool)

On the Home Page press the following to accept default PSet Parameters:

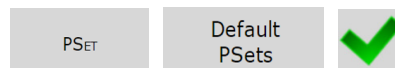

This will generate three generic PSets for the tool connected to the controller. It will automatically use the 40%, 60%, and 80% of the rated maximum torque of the tool in a two-stage Torque Control Strategy (TC). A prompt will display rated Max Torque and Max RPM of the connected tool for reference. These Psets can be modified to meet application requirements.

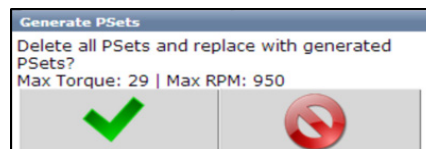

## 4. Home Page (Main Menu)



### 4.1 Run

The Run Screen is essentially the dashboard of the Gen IV controller and provides a look at real-time information regarding rundowns.

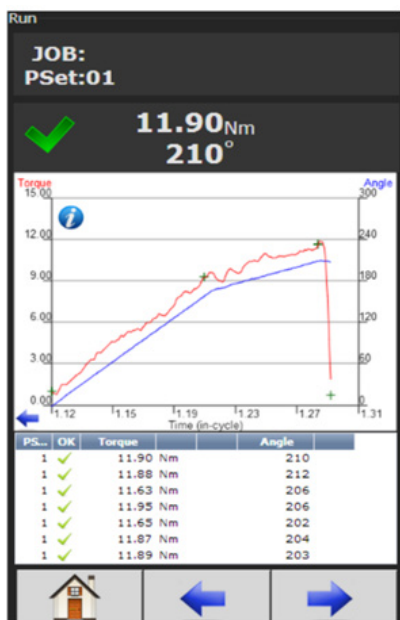

Time (In-Cycle) Screen

<b>JOB:</b>	Indicates the current JOB.
<b>PSet:01</b>	Indicates the current PSet in which you are operating.
	Indicates accepted rundown.
	Indicates failed rundown.
<b>11.90Nm</b> <b>210°</b>	Displays Torque and Angle for current rundown.

Graph displays curves representing Torque (black trace) and Angle (blue trace). The blue left arrow at the origin of the graph will change the X-axis of the rundown curve from Time (In-Cycle) to Time (Overall) and Angle.

Below the graph is a historical table that will give information and status of the most recent rundowns, including current PSet, accepted/failed rundown status, torque and angle.



Arrows allow user to scroll through screens that show real time Job information such as Run Screen or rundown indicators.

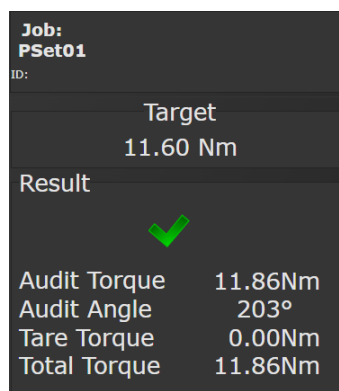

Home tab will return user to the Home Page

On the Run Screen, click for curve detail.

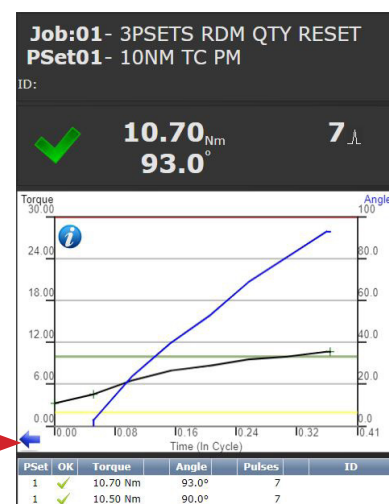

Click on blue arrow to change curve X axis.

Choose Time In-cycle, Time Overall, Angle, or Angle In-Cycle screen



## Large Screen Indicators and Audit information

The large screen indicators are helpful in viewing real time results of the rundown from a distance.

Example of Accepted Job

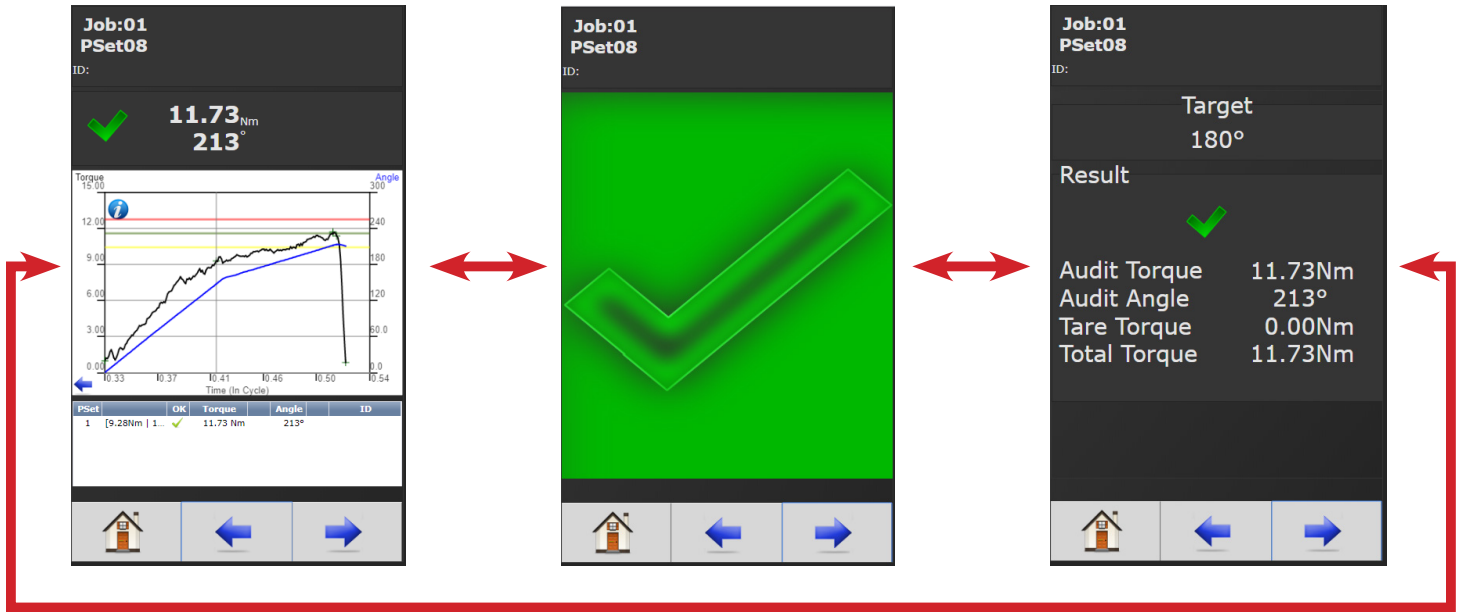

Example of Failed Job

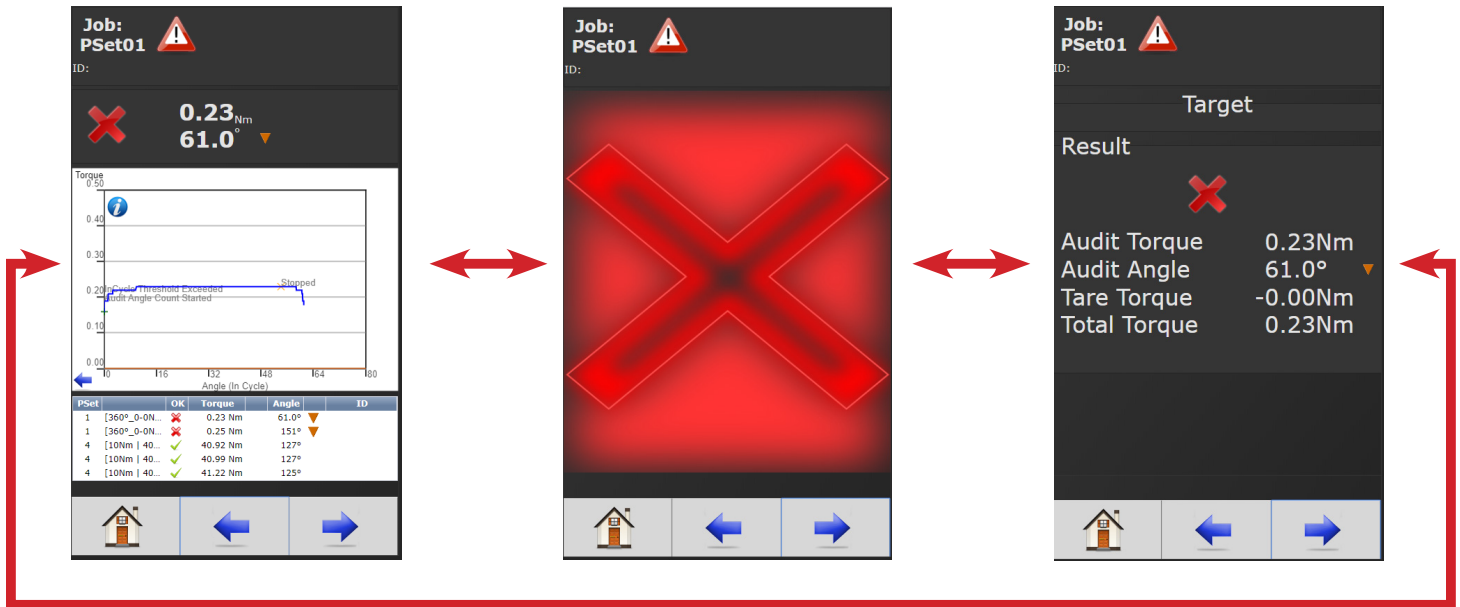

## 4.2 PSet

Parameter Settings (PSets) control the fastening process. The following describes the different fastening strategies and how to setup the basic PSet parameters necessary to perform a fastening. Up to 256 PSets are available.





**For AcraDrive capable tools see "4.2.1.2 AcraDrive Discontinuous Drive Mode Settings" on page 11.**

### 4.2.1 Add New PSet

On Home Page press the  tab.

On PSets screen press  to add a new Pset.



-  Add a PSet
-  Edit a PSet
-  Copy a PSet
-  Delete a PSet

**Default PSets:** See "3.2 Quick Set Up" on page 7.

**Manage:** See "4.2.6 Manage PSets" on page 27.

On Add New PSet screen (below) enter appropriate values.

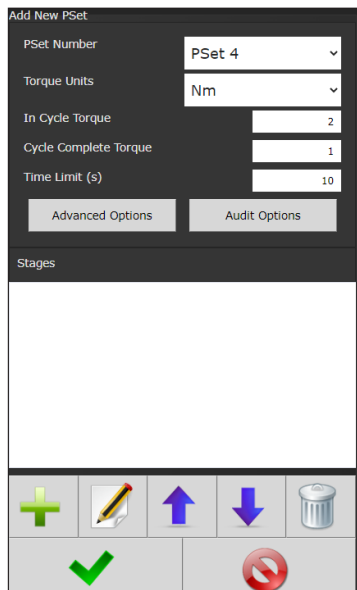

**PSet Number:** Current PSet to be added.

**Torque Units:** Unit of measure.

**In Cycle Torque:** Threshold value at which tool is "In Cycle" and results from the Rundown will be reported.

**Cycle Complete Torque:** Torque level that determines completion of a fastening cycle.

**Time Limit(s):** Maximum allowable time (in seconds) tool is allowed to run.

**Advanced Options:** see "4.2.4 Advanced Options" on page 26

**Audit Options:** A PSet can be assigned 20 stages, and a tightening or loosening event can be performed in any of them. The Audit Options button allows the user to select the one stage that is of most importance and make the OK/NOK judgment of the event based on what transpires in that Stage. Default performs the Audit function after the last Stage completes.

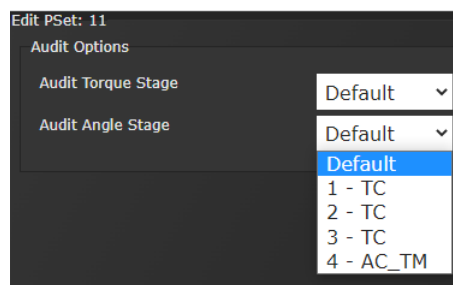

Once PSet values are entered press  to enter Add New Stage screen.

#### 4.2.1.1 Add New Stage

A single stage or multiple stages build a PSet. Up to 20 stages can be assigned per PSet.

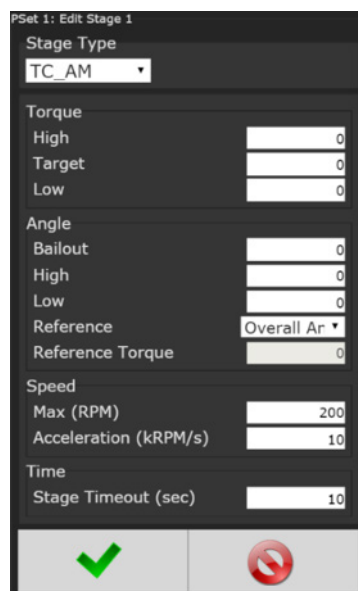

The following stage options are available:

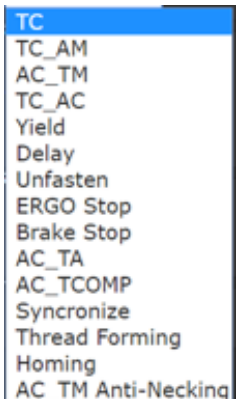

Once the desired stage(s) are selected and configured, press to save stage and again to save the PSet and return to initial PSet menu.

Next Press to go to the RUN screen or to return to the Home page. The tool should now be operational and you are ready to run a configured PSet.

#### 4.2.1.2 AcraDrive Discontinuous Drive Mode Settings

The iEC Discontinuous Mode pulses the tool output to reduce torque reaction forces on the operator. To accomplish this, the tool relies on motor and gear inertia to transmit torque to the fastener instead of only the torque capability of the motor. Discontinuous Mode is only available for tools designed for discontinuous mode operation.

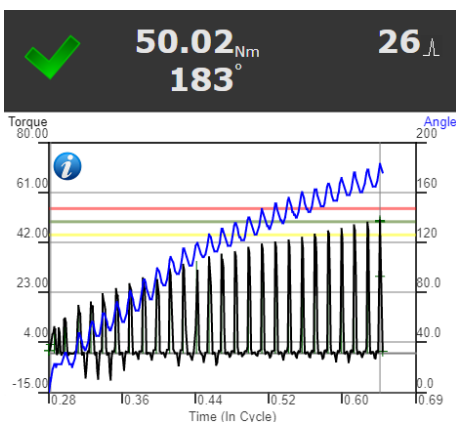

#### Discontinuous Mode Stages

The following stages can be used in Discontinuous Mode:

- TC (Torque Control)
- TC\_AM (Torque Control, Angle Monitor)
- AC\_TM (Angle Control, Torque Monitor)
- TC\_AC (Torque Control, Angle Control)

#### Discontinuous Mode Parameters

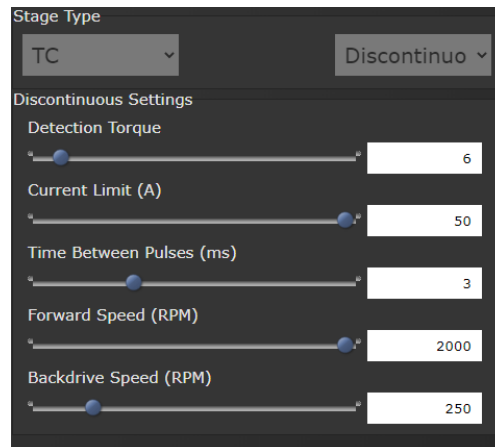

**Detection Torque:** 1.0 – 10 Nm, 0.1 – 1.0 kgm, 0.75 – 7.5 ft-lb, 9.0 – 90 in-lb

- The Torque Value at which the forward-moving state transitions to the backward-moving state. Higher values for Detection Torque mean that in order to determine a pulse, the impact torque is greater than the Detection Torque.

**Current Limit:** 10 – 50 A

- Maximum current allowed throughout the duration of the rundown. Higher values allow more aggressive fastening, but lower values can improve accuracy.

**Time Between Pulses:** 0 – 10 ms

- How long to wait before the next pulse.

**Forward Speed:** 100 – 2000 RPM

- How fast to rotate in the fastening direction.

**Backdrive Speed:** 100 – 1000 RPM

- How fast to rotate in the un-fastening direction.

## Discontinuous Mode Disassembly Parameters

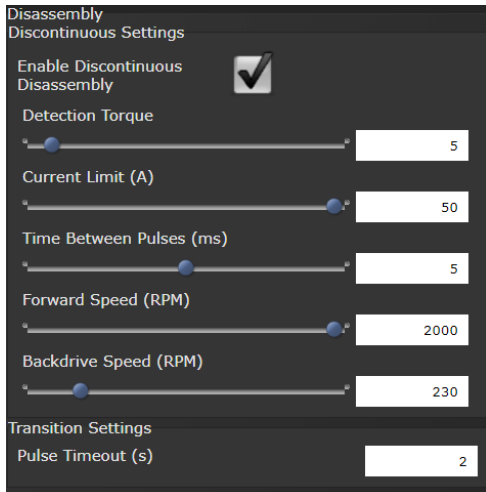

### Enable Discontinuous Disassembly:

- Determines whether to utilize Discontinuous Mode in disassembly. Only tools with Discontinuous Mode enabled can use this mode.

**Detection Torque:** 1.0 – 10 Nm, 0.1 – 1.0 kgm, 0.75 – 7.5 ft-lb, 9.0 – 90 in-lb

- The Torque Value at which the forward-moving state transitions to the backward-moving state. Higher values for Detection Torque mean that in order to determine a pulse, the impact torque is greater than the Detection Torque.

**Current Limit:** 10 – 50 A

- Maximum current allowed. Higher values allow more aggressive fastening, but lower values can improve accuracy.

**Time Between Pulses:** 0 – 10 ms

- How long to wait before the next pulse.

**Forward Speed:** 100 – 2000 RPM

- How fast to rotate in the fastening direction.

**Backdrive Speed:** 100 – 1000 RPM

- How fast to rotate in the un-fastening direction.

**Pulse Timeout:** 0.1 – 10 seconds

- Amount of time not detecting a pulse required to transition into normal continuous disassembly.
  - When running in disassembly, the Pulse Time Out timer will start counting down and reset each time a pulse is detected
  - If a pulse is not detected before the timer times out, the tool will slow down to the continuous speed setting. This can help prevent the fastener from completely backing off the threads when disassembling.

- If another pulse is detected while running the slower speed. The Pulse Time Out timer will reset, allowing the speed to return to the pulse Forward Speed setting.

## Discontinuous Mode Sequence of Operation:

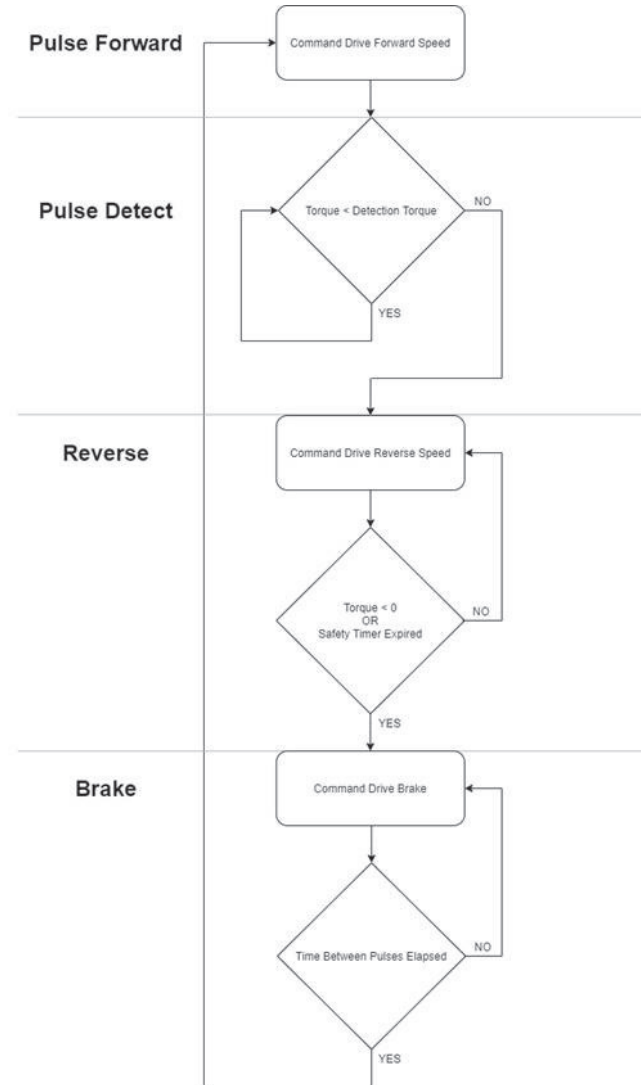

The following steps occur in sequence until either the target torque has been reached, a fault occurs, or a limit is reached:

1. The motor is commanded forward at Forward Speed until the measured torque exceeds Detection Torque.
2. The motor is commanded backward at Backdrive Speed until either the measured torque becomes negative, or an internal safety timer has expired.
3. The motor is commanded to brake until Time Between Pulses has elapsed.

## Optimization and Troubleshooting

The following are examples of potential issues and how they can potentially be solved with minor tweaks to the Pulse Settings mentioned previously in this section.

- **The tool stalls and struggles to reach the Target Torque:**

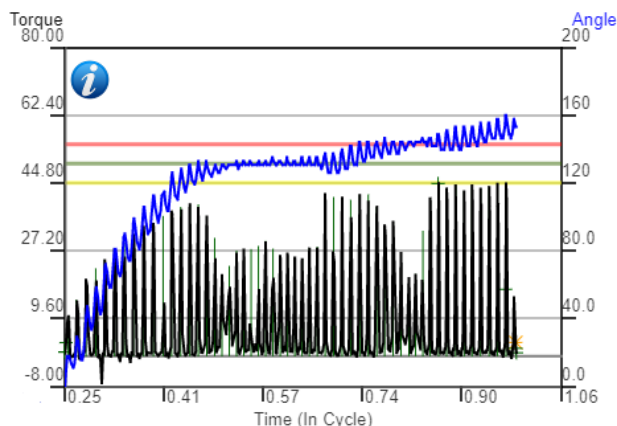

- Increase Current Limit if it isn't already at the maximum allowed value.
  - Increase Backdrive Speed to prevent the tool from vibrating in place (the flat spot on the angle graph above shows an example of this).
- **The tool exceeds the High Torque limit:**
  - Decrease Current Limit to create softer pulses.
  - Decrease Forward Speed to reduce torque overshoot.
  - If neither of the above fix the problem, try the following:
    - Change the PSet to have two Discontinuous Mode stages instead of one:
      - ▶ The first should be more aggressive, with maximum Current Limit and/or Forward Speed.
      - ▶ The second should be less aggressive, with decreased Current Limit and/or Forward Speed.
    - Ensure the PSet has a Brake Stop stage at the end.
  - Increasing Detection Torque can also sometimes increase torque accuracy.
- **The tool is not driving the fastener forward:**
  - Decrease Backdrive Speed to ensure the tool doesn't back off too much after a pulse.
- **The reaction force on the operator is too much:**
  - Decrease Detection Torque.
  - Decrease Current Limit.
  - Decrease Forward Speed.

## 4.2.2 PSet Stages

### 4.2.2.1 TC Torque Control Stage

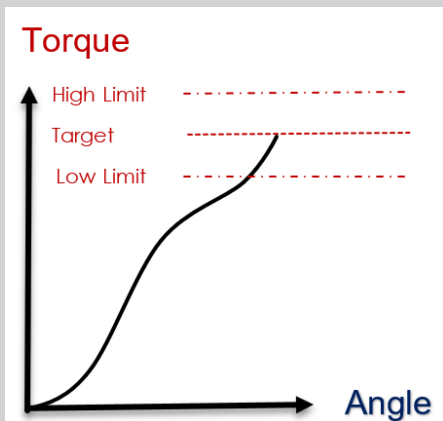

Control strategy uses torque as the only control parameter. The tool stops when *Torque Target* is reached. Rundown is considered to be successful (Accept) if the stage peak torque value falls within the range specified by the *Torque High Limit* and the *Torque Low Limit* parameters.

PSet 13: Edit Stage 1

Stage Type

TC Continuous

Torque

High 10

Target 5

Low 2

Speed

Speed (RPM) 500

Acceleration (kRPM/s) 10

Time

Stage Timeout (s) 10

#### Stage Type:

- Continuous Drive
- Discontinuous Drive

**Torque High:** The upper control limit of the rundown.

**Torque Target:** Final desired torque.

**Torque Low:** The lower control limit of the rundown.

**Speed (RPM):** Tool Output speed target.

**Acceleration (kRPM/s):** The length of time it will take for tool to change speed. The lower the value the slower the acceleration (see "Glossary" on page 60 for detailed description).

**Stage Timeout (s):** Maximum allowable time (in seconds) in this stage. If time is exceeded, the tool will stop and Rundown will be terminated.

## 4.2.2.2 TC\_AM Torque Control Angle Monitor Stage

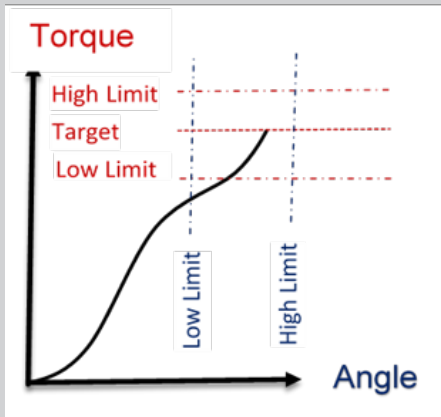

Control strategy is convenient for detection of cross threaded or stripped fasteners. Rundown is considered to be successful (Accept) if the stage peak torque value falls within range specified by *Torque High Limit* and *Torque Low Limit* and final angle value falls within the range specified by *Angle High Limit* and *Angle Low Limit* parameters.

### Stage Type:

- Continuous Drive
- Discontinuous Drive

**Torque High:** Upper control limit of the rundown.

**Torque Target:** Final desired torque.

**Torque Low:** The lower control limit of the rundown.

**Angle Bailout:** Determines when to stop the tool on angle during any Torque Control strategy. Should be set equal to or above High Angle. Units are degrees of rotation.

**Angle High:** Maximum acceptable angle rotation in degrees.

**Angle Low:** Minimum acceptable angle rotation in degrees.

### Angle Reference: (drop down menu)

- **Overall Angle:** Angle is measured starting from lever/trigger pull.
- **In-cycle Angle:** Angle is measured from In-Cycle torque value (determined in PSet screen).
- **Stage Angle:** Angle is measured from Reference Torque. If Stage Angle is selected, this will be the start point (in Torque) at which angle is monitored.

**NOTE:** Set Reference Torque to zero to measure Stage Angle from the beginning of the stage.

**Reference Torque:** If Stage Angle is selected in the Reference menu, this will be the Torque start point at which angle is monitored.

**Speed (RPM):** Tool Output speed target.

**Acceleration(kRPM/s):** How quickly the tool will change speed. The lower the value the slower the acceleration (see "Glossary" on page 60 for detailed description).

**Stage Timeout (s):** Maximum allowable time (in seconds) in this stage. If time is exceeded, the tool will stop and the Rundown will be terminated.

PSet 13: Edit Stage 1  
Stage Type

TC\_AM      Continuous

Torque

High      10

Target      5

Low      2

Angle

Bailout      600

High      600

Low      0

Reference

Reference Torque

In Cycle Ar

Overall Angle

In Cycle Angle

Stage Angle

Speed

Speed (RPM)      500

Acceleration (kRPM/s)      10

Time

Stage Timeout (s)      10

✓      ⛔

## 4.2.2.3 AC\_TM Angle Control Torque Monitor Stage

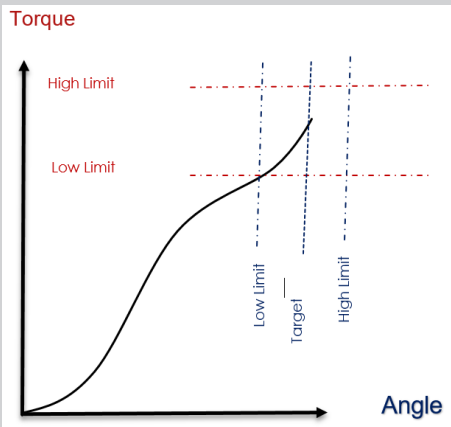

Control strategy in which the tool stops when *Angle Target* is reached or *Torque High Limit* is exceeded. Rundown is considered to be successful (Accept) if the stage peak torque value falls within range specified by torque upper and lower limits and final angle value falls within the range specified by *Angle High Limit* and *Angle Low Limit* parameters.

### Stage Type:

- Continuous Drive
- Discontinuous Drive

**Angle High:** Maximum allowed angle rotation in degrees.

**Angle Target:** Angle target desired.

**Angle Low:** Minimum allowed angle rotation in degrees.

**Angle Reference:** (drop down menu)

- **Overall Angle:** Angle is measured starting from lever/trigger pull.
- **In-cycle Angle:** Angle is measured from In-Cycle torque value (Determined in PSet screen).
- **Stage Angle:** Angle is measured from Reference Torque.

**Reference Torque:** If Stage Angle is selected in the reference menu, this will be the start point (in Torque) at which angle is monitored.

**NOTE:** Set Reference Torque to zero if you want Stage Angle measured from the beginning of the stage.

**Torque Bailout:** Determines when to stop the tool based on torque value during any *Angle Target* value should be equal or greater than High Torque.

**Torque High:** Upper control limit of the rundown.

**Torque Low:** Lower control limit of the rundown.

**Speed (RPM):** Tool Output speed target.

**Acceleration (kRPM/s):** How quickly the tool will change speed. The lower the value, the slower the acceleration (see "Glossary" on page 60 for detailed description).

**Stage Timeout (s):** Maximum allowable time (in seconds) in this stage. If time is exceeded, the tool will stop and the Rundown will be terminated.

PSet 13: Edit Stage 1  
Stage Type

AC\_TM      Continuous

Angle

High      600

Target      540

Low      0

Reference      In Cycle Ar

Reference Torque      0

Torque

Bailout      15

High      10

Low      2



Speed

Speed (RPM)      500

Acceleration (kRPM/s)      10

Time

Stage Timeout (s)      10



## 4.2.2.4 TC\_AC Torque Control Angle Control Stage

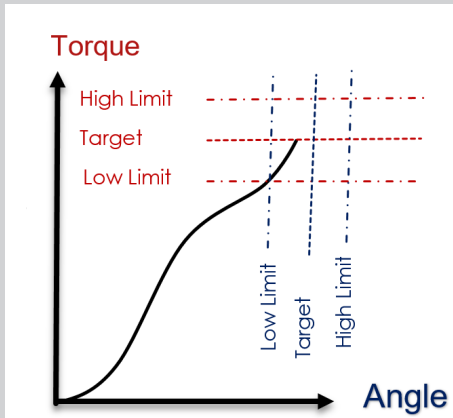

Control strategy in which the tool stops if *Target Torque* or *Target Angle* is reached, whichever happens first.

Rundown is considered to be successful (Accept) if the stage peak torque value falls within range specified by *Torque High Limit* and *Torque Low Limit*, and final angle value falls within the range specified by *Angle High Limit* and *Angle Low Limit* parameters.

### Stage Type:

- Continuous Drive
- Discontinuous Drive

**Torque High:** Upper control limit of the rundown.

**Torque Target:** Final desired torque.

**Torque Low:** Lower control limit of the rundown.

**Angle High:** Maximum allowed angle rotation in degrees.

**Angle Target:** Angle target desired.

**Angle Low:** Minimum allowed angle rotation in degrees.

**Angle Reference:** (drop down menu)

- **Overall Angle:** Angle is measured starting from lever/trigger pull.
- **In-cycle Angle:** Angle is measured from In-cycle value (determined in PSet screen.)
- **Stage Angle:** Angle is measured from Reference Torque.

**Reference Torque:** If Stage Angle is selected in the Reference Menu, this will be the start point (in Torque) at which angle is monitored.

**NOTE:** Set Reference Torque to zero if you want Stage Angle measured from the beginning of the stage.

**Speed (RPM):** Tool Output speed target.

**Acceleration (kRPM/s):** How quickly the tool will change speed. The lower the value, the slower the acceleration (see "Glossary" on page 60 for detailed description).

**Stage Timeout (s):** Maximum allowable time (in seconds) in this stage. If time is exceeded, the tool will stop and the Rundown will be terminated.

PSet 13: Edit Stage 1  
Stage Type

TC\_AC Continuous

Torque

High	10
Target	5
Low	2

Angle

High	600
Target	540
Low	0

Reference In Cycle Ar

Reference Torque

Speed

Speed (RPM)	500
Acceleration (kRPM/s)	10

Time

Stage Timeout (s)	10
-------------------	----

✓
⊘

## 4.2.2.5 Yield Control Stage

PSet 1: Edit Stage 1  
Stage Type

Yield

Yield Target %

Torque

Bailout

High

Low

Angle

Bailout

High

Low

Reference

Reference Torque

Speed

Speed (RPM)

Acceleration (kRPM/s)

Time

Stage Timeout (s)

This strategy detects the yield of the fastener and reports the torque and angle that resulted from the fastening event.

Controlling by detecting Yield is very beneficial on joints where clamp load varies greatly relative to final torque.

This strategy can be used alone or combined with other strategies as steps in a parameter set. As an example, a common fastening strategy could be three steps:

- Torque Stage – To set a minimum threshold
- Yield Stage – To control clamp load
- Angle Stage – To attain a specific bolt stretch above Yield

**Yield Target %:** Programmable with a default setting of 50%.

The lower this value, the more sensitive the strategy will be. Too low could cause early and false detection.

The higher this value, the less sensitive the strategy will be. A more pronounced change in slope is required for the yield to be determined.

The measurement is joint specific and 0% when parallel to the slope determined to be the elastic range and 100% is when the slope is horizontal.

Joint Rate parameters have default settings of 5 samples every 20 degrees. This resolution can be adjusted if needed.

See "AC\_TM Angle Control Torque Monitor Stage" on page 16 for Torque, Angle, Speed, and Time parameter details).

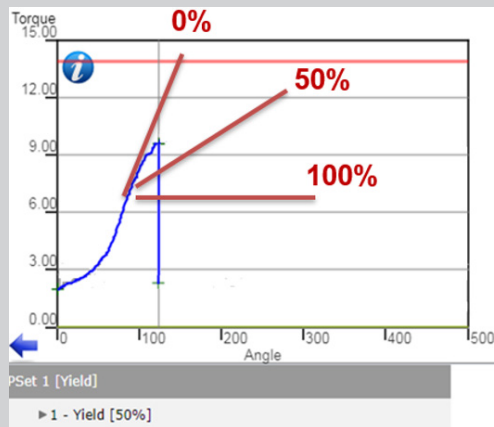

**Torque Bailout:** Determines when to stop the tool based on torque value during any Angle Torque Bailout value should be equal or greater than High Torque.

**Torque High:** Upper control limit of the rundown.

**Torque Low:** Lower control limit of the rundown.

**Angle Bailout:** Determines when to stop the tool on angle during any Torque Control strategy. Should be set equal to or above High Angle. Units are degrees of rotation.

**Angle High:** Maximum acceptable angle rotation in degrees.

**Angle Low:** Minimum acceptable angle rotation in degrees.

**Angle Reference:** (drop down menu)

- **Overall Angle:** Angle is measured starting from lever/trigger pull.
- **In-cycle Angle:** Angle is measured from In-Cycle torque value (determined in PSet screen).
- **Stage Angle:** Angle is measured from Reference Torque. If Stage Angle is selected, this will be the start point (in Torque) at which angle is monitored.  
**NOTE:** Set Reference Torque to zero to measure Stage Angle from the beginning of the stage.

**Reference Torque:** If Stage Angle is selected in the Reference menu, this will be the Torque start point at which angle is monitored.

**Speed (RPM):** Tool Output speed target.

**Acceleration(kRPM/s):** How quickly the tool will change speed. The lower the value the slower the acceleration (see "Glossary" on page 60 for detailed description).

**Stage Timeout (s):** Maximum allowable time (in seconds) in this stage. If time is exceeded, the tool will stop and the Rundown will be terminated.

## 4.2.2.6 Delay Stage

PSet 1: Edit Stage 1  
Stage Type

Delay

Time

Delay (s)

This stage determines the time delay between stages.

**Time Delay (s):** Total time (in seconds) the tool stops and waits before proceeding to the next stage. Default is 0.2 (sec).

## 4.2.2.7 Unfasten Stage

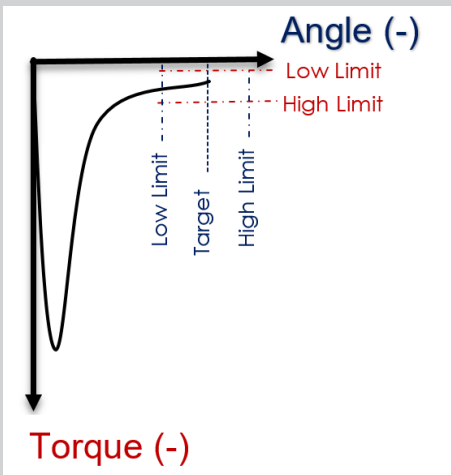

This feature is a specific “backoff” stage used, for example, in a Rundown-Backoff or Rundown-Backoff-Rundown configuration. NOTE: In this stage, the tool always runs opposite of the thread direction.

PSet 1: Edit Stage 1  
Stage Type

Unfasten

Angle

High

Target

Low

Torque

Bailout

High

Low

Speed

Speed (RPM)

Acceleration (kRPM/s)

Audit

Enable

Time

Stage Timeout (s)

**Angle High:** Maximum allowed angle rotation in degrees.

**Angle Target:** Degrees of rotation the tool will backoff in reverse.

**Angle Low:** Minimum allowed angle rotation in degrees.

**Torque Bailout:** Determines when to stop the tool based on torque value during any Angle Control strategy; should be equal or greater than High Torque.

**Torque High:** Upper control limit of the rundown.

**Torque Low:** Lower control limit of the rundown.

**Speed (RPM):** Tool Output speed target (in the unfastening direction).

**Acceleration (kRPM/s):** How quickly tool will change speed. The lower the value, the slower the acceleration (see "Glossary" on page 60 for detailed description).

### Audit Enable:

**False:** When set to False the stage will not be evaluated for pass or fail.

**True:** When set to True the stage will be evaluated for pass or fail using high and low limits.

**Stage Timeout (s):** Maximum allowable time (in seconds) in this stage. If time is exceeded, the tool will stop and the Rundown will be terminated.

## 4.2.2.8 Ergo Stop Stage

PSet 1: Edit Stage 1  
 Stage Type  
 ERGO Stop ▾

Time  
 Ramp Down Time (s)

Torque  
 Current Reduction %

Ramps cut-off power when fastening achieves *Target Torque* or *Target Angle* value. This feature reduces torque reaction to the operator in a hand-held tool as final torque or angle is achieved.

**Ramp Down Time (s):** Total time (in seconds) to ramp down to zero current/torque.

**Torque Current Reduction %:** Amount (in percent) to reduce the current to the motor.

## 4.2.2.9 Brake Stop Stage

PSet 4: Add New Stage  
 Stage Type  
 Brake Stop ▾

Time  
 Max Brake Hold Time (s)   
 Duty Cycle (%)   
 Auto-Release

The Brake Stop Stage is used for electronic braking of the tool. It can be helpful in applications where a high RPM is used for the rundown, helping to reduce torque and angle target overshoot.

The Brake Stop stage is also required after a high torque target stage, to prevent the tool motor from springing backwards too fast as the tool gearing relaxes. This motor back drive can cause a voltage spike on the drive DC bus. This spike in voltage can result in drive or other faults to occur. As a guideline, rundowns exceeding 1,000Nm should have a brake stop as the final stage.

**Max Brake Hold Time (s):** Amount of time (in seconds) that brake is applied.

**Duty Cycle %:** Manual control the strength of the brake force – a higher value is stronger

**Auto-Release:** Automatically controls the strength of the brake force and releases when cycle complete torque is reached. It is recommended to enable this when using the brake stop to relax the joint after a high torque rundown, to prevent voltage spikes.

## 4.2.2.10 AC\_TA Angle Control Torque Averaging Stage

PSet 1: Edit Stage 1  
Stage Type

AC\_TA

Angle

Target

Low

Reference

Reference Torque

Torque

Bailout

High

Average High

Average Low

Speed

Speed (RPM)

Acceleration (kRPM/s)

Time

Stage Timeout (s)

Control Strategy that is helpful in applications where the rotational resistance measured can produce a pass or fail reading. This will help in gauging rolling resistance of a given part and aid in detecting latent failures in rotating assemblies.

**Angle Target:** Angle target desired.

**Angle Low:** Minimum allowed angle rotation in degrees.

**Angle Reference:** (drop down menu)

- **Overall Angle:** Angle is measured starting from lever/trigger pull.
- **In-cycle Angle:** Angle is measured from In-Cycle torque value determined in PSet screen).
- **Stage Angle:** Angle is measured from Reference Torque.

**Reference Torque:** If Stage Angle is selected in the Reference menu, this will be the Torque start point at which angle is monitored.

**Torque Bailout:** Determines when to stop the tool based on torque value during any Angle. Torque Bailout value should be equal or greater than High Torque.

**Torque High:** Upper control limit of the rundown.



**Average High:** The average high torque of the rundown.

**Average Low:** The average low torque of the rundown.

**Speed (RPM):** Tool Output speed target.

**Acceleration (kRPM/s):** How quickly the tool will change speed. The lower the value the slower the acceleration (see "Glossary" on page 60 for detailed description).

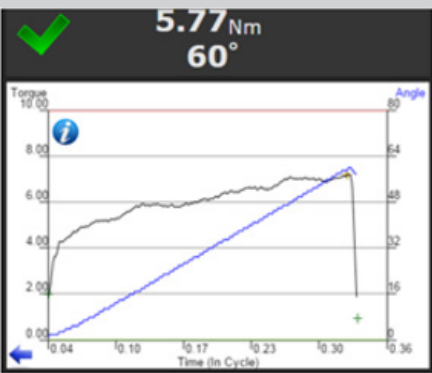
**Stage Timeout (s):** Maximum allowable time (in seconds) in this stage. If time is exceeded, the tool will stop and the Rundown will be terminated.

Pass	Fail
	
<p>Average Torque falls within Avg. Torque limits.</p> <p>Reported torque is the average of the torque measured during the AC_TA Stage.</p> <p>Notice that final torque is greater than the Avg. Torque High limit.</p>	<p>Average Torque greater than Avg. Torque High limit.</p> <p>Reported torque is the average of the torque measured during the AcTa Stage.</p>

## 4.2.2.11 AC\_TCOMP Angle Control Torque Compensation Stage

PSet 1: Edit Stage 1  
Stage Type

AC\_TCOMP ▾

Angle

Target

Low

Reference

Reference Torque

Torque

Bailout

High

Average High

Average Low

Speed

Speed (RPM)

Acceleration (kRPM/s)

Time

Stage Timeout (s)

✔
✘

The Angle Control Torque Compensation Strategy is used to compensate for the prevailing torque of the fastener. The prevailing torque can be averaged over a set angle and the torque will be adjusted by the average torque measured, allowing it's effect to be removed from the final torque applied to the fastener.

**Setup:** See "AC\_TA Angle Control Torque Averaging Stage" on page 21.

This strategy will behave the same as Angle Control Torque Averaging (AC\_TA) with the additional re-taring of the torque transducer; it has all the same parameters.

### The Problem

In the two following fastening cycles, the final torque is 4Nm. The first fastening has about 1Nm of prevailing torque during the free run and the second has about 2Nm. In the first fastening, about 3Nm of torque goes into the final clamping load of the joint. The second fastening only gets about 2Nm of torque to clamp the part, 33% less than the first.

### Removing the Prevailing Torque

The strategy will measure the average prevailing torque over a given angle. At the completion of the stage the torque transducer will have its tare value adjusted by the average torque. Removing the prevailing torque readings for the remainder of the fastening cycle.

In the fastening shown, the first stage is an Angle Control Torque Compensation strategy followed by a torque control strategy to 4Nm. This will allow a consistent 4Nm to be applied to the clamp load of the part.

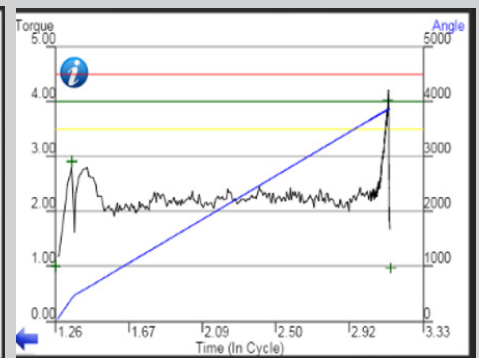
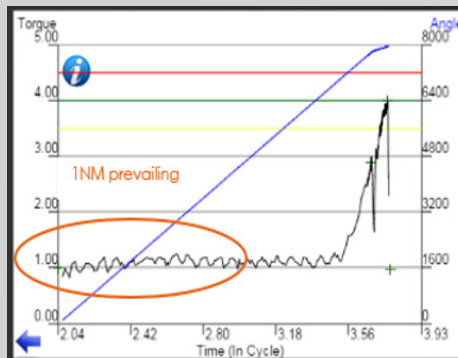

## 4.2.2.12 AC\_TCOMP Display of Torque Compensation Value



**LED Display:** The bottom LED display field can be configured to display the Torque Compensation Tare Value by using the toggle button to select 'COMP' from the available options.

**Run Screen:** In addition to the Final Audit Torque, the Final Torque Total and the Torque Compensation Value will be displayed if an AC\_TComp stage was completed during the rundown.

Target	
100.00 Nm	
Results	
Audit Torque	101.2 Nm
Tare Value	23.2 Nm
Total Torque	124.4 Nm

## 4.2.2.13 Sync Stage

PSet 1: Edit Stage 1  
Stage Type

Synchronize ▾

Time

Stage Timeout (s)

Set synchronization point between stages for spindle networks. All spindles will wait on this stage until all controllers are ready to proceed to the next stage.

**Stage Timeout (s):** Total time in seconds the controller will wait in this stage before timing out and aborting the rundown.

## 4.2.2.14 Thread Forming Stage

PSet 1: Edit Stage 1  
Stage Type

Thread Form ▾

Angle

High

Target

Low

Reference

Reference Torque

Torque

Bailout

High

Low



Speed

Speed (RPM)

Acceleration (kRPM/s)

Time

Stage Timeout (s)

The 'Thread Forming PSet Strategy' can be used in fastening applications where the initial thread forming torque is greater than the final torque target to be left on the fastener. This strategy is intended to be used as the first stage of a multistage PSet, prior to the final audit stage.

The Thread Forming Strategy is a variant of the Angle Control Torque Monitoring (AC\_TM) Stage, which in addition, includes a reset of the overall peak torque value when the stage completes. This provides a way to reset the peak torque value after thread forming so that only the peak torque from the fastening portion of the rundown is used for the overall evaluation of the rundown and reported.

**Sequence of Operation:** The stage will run until the angle target is reached, or is terminated early. If the stage completes successfully the overall peak torque is reset to the current torque value, then the next stage in the sequence will begin. If the stage is terminated early, or fails on the torque and angle limits, the overall peak torque is not reset and the rundown will be terminated.

**Setup:** See "AC\_TM Angle Control Torque Monitor Stage" on page 16 for Torque, Angle, Speed, and Time parameter details)

## 4.2.2.15 Homing Stage

PSet 1: Edit Stage 1  
Stage Type

Homing ▾

Angle

High	5
Low	5

Torque



Bailout	9.24
High	6.16
Low	5.04

Speed

Speed (RPM)	104
Acceleration (kRPM/s)	10

Time

Stage Timeout (s)	10
-------------------	----

Control strategy in which the tool's output returns to a home position in the direction set in the parent PSet. The home position is defined by the position of the output when the controller is powered on. The stage is considered successful (Accept) if the output travels and stops within the home region, defined by the angle high and low limits. If the output is already in the home region when the stage begins, the tool will perform a revolution first. When the output crosses the lower limit, the tool will brake to a stop. After completing the stage, the position of the output, referenced from the home position, will be reported.

**Angle High:** Upper limit of the Tool Output position defining the home region. (Units: Degrees from the Home position in the direction of rotation defined in the PSet)

**Angle Low:** Lower limit of the Tool Output position defining the home region. (Units: Degrees from the Home position in the opposite direction of rotation defined in the PSet).

**Torque Bailout:** The tool will stop if this torque is exceeded. The Torque Bailout value should be equal or greater than High Torque.

**Torque High:** Upper control limit of the rundown.

**Torque Low:** Lower control limit of the rundown.

**Speed (RPM):** Tool Output speed target.

**Acceleration (kRPM/s):** How quickly the tool will change speed. The lower the value the slower the acceleration (see "Glossary" on page 60 for detailed description).

**Stage Timeout (s):** Maximum allowable time (in seconds) in this stage. If time is exceeded, the tool will stop and the Rundown will be terminated.

**Note:** To maintain the tool's home position without drifting, some tools will require a more refined value for the tool parameter PPRO. Please contact an AIMCO representative for instructions on how to load this value into the tool if it is needed.



## 4.2.2.16 AC\_TM Anti-Necking Stage

PSet 1: Edit Stage 1  
Stage Type

AC\_TM Anti ▾

Angle

High

Target

Low

Reference

Reference Torque

Torque

Bailout

High

Low

Percent Peak Torque Drop



Speed

Speed (RPM)

Acceleration (kRPM/s)

Time

Stage Timeout (s)

Control strategy in which the tool stops when *Angle Target* is reached, or *Torque High Limit* is exceeded. Rundown is considered to be successful (Accept) if the stage peak torque value falls within the range specified by torque upper and lower limits and final angle value falls within the range specified by *Angle High Limit* and *Angle Low Limit* parameters. If the final torque of the rundown is not within the parameter specified by *Percent Peak Torque Drop*, the rundown is considered to be unsuccessful and a low torque will be reported.

**Angle High:** Maximum allowed angle rotation in degrees.

**Angle Target:** Angle target desired.

**Angle Low:** Minimum allowed angle rotation in degrees.

**Angle Reference:** (drop down menu)

- **Overall Angle:** Angle is measured starting from lever/trigger pull.
- **In-cycle Angle:** Angle is measured from In-Cycle torque value (determined in PSet screen).
- **Stage Angle:** Angle is measured from Reference Torque.

**Reference Torque:** If Stage Angle is selected in the Reference menu, this will be the start point (in Torque) at which angle is monitored.

**NOTE:** Set Reference Torque to zero if you want Stage Angle measured from the beginning of the stage.

**Torque Bailout:** Determines when to stop the tool based on torque value during any Angle Torque Bailout value should be equal or greater than High Torque.

**Torque High:** Upper control limit of the rundown.

**Torque Low:** Lower control limit of the rundown.

**Percent Peak Torque Drop:** The maximum allowed percentage torque drop from peak torque during a rundown. If the final torque is too low, a low torque will be reported.

**Speed (RPM):** Tool Output speed target.

**Acceleration (kRPM/s):** How quickly the tool will change speed. The lower the value the slower the acceleration (see "Glossary" on page 60 for detailed description).

**Stage Timeout (s):** Maximum allowable time (in seconds) in this stage. If time is exceeded, the tool will stop and the Rundown will be terminated.

## 4.2.3 Edit PSet

On Home page press 

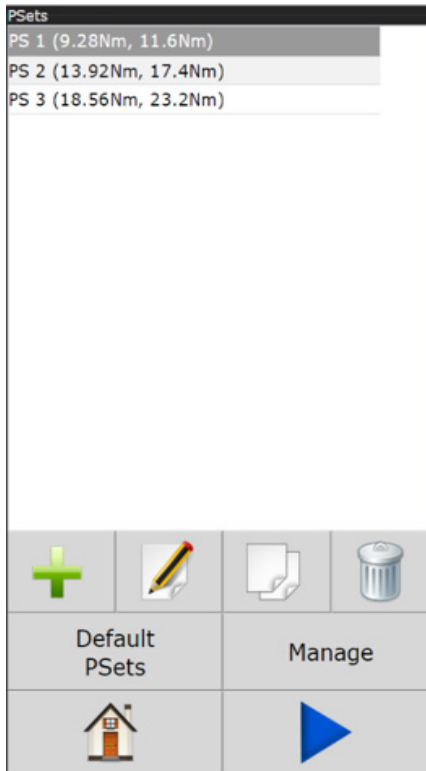

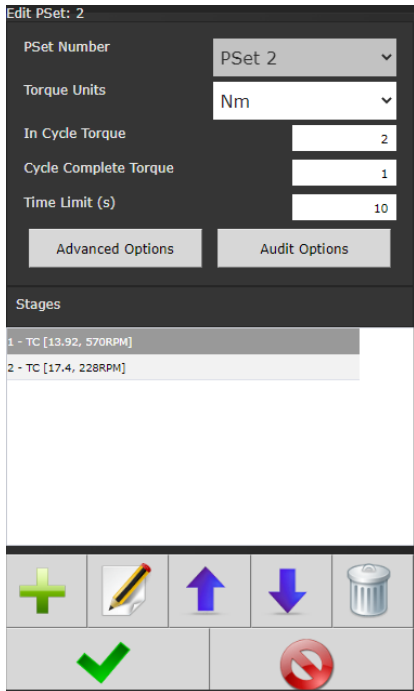

On the PSet screen click on the desired PSet you would like to edit.

Click on the Edit button  to make changes in the Edit screen (below).

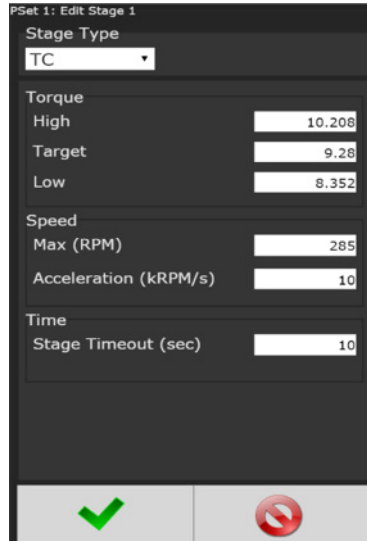

If further Stage changes are needed click the Edit button  again to enter Edit Stage screen (below).



Once desired changes are made click  twice to save changes.

## 4.2.4 Advanced Options

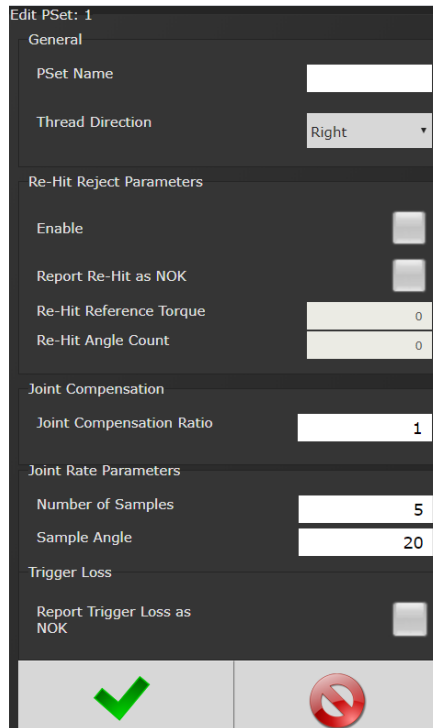

**PSet Name:** Add PSet name if desired (up to 10 characters).

**Thread Direction:** Defines fastening direction (default is right hand).

**Re-hit/Reject Parameters:** Prevents the fastening of an already tightened fastener. If enabled, tool will stop and the rundown will be aborted, if the angle of rotation

between the Re-Hit Reference Torque and the In-Cycle Torque is less than the Re-Hit Angle Count.

**NOTE:** If the attempted rundown is a Re-Hit, it will not be reported or recorded.

**Re-hit Reject Enable:** Enables the feature.

**Re-Hit Reference Torque:** This torque value is the start of the angle count that determines a Re-Hit. (This value should be lower than the In Cycle Torque specified in the PSet.)

**Re-Hit Angle Count:** If the angle count between the Re-Hit Reference Torque and the In Cycle Torque is less than this value, the rundown is determined to be a Re-Hit.

**Joint Compensation Ratio:** Adjusts the target torque of the tool to compensate for joint characteristics. This value has an inverse relationship with the target torque (Output torque = Target Torque / Ratio). Ratio values above 1.0 result in a lower output torque where values below 1.0 result in higher output torques.

**Joint Rate Parameters:** Joint rate parameters have default settings of 5 samples every 20 degrees. This resolution can be adjusted if needed.

Joint Rate Parameters	
Number of Samples	5
Sample Angle	20

**Report Trigger Loss as NOK:** If enabled and a rundown is terminated early before completion:

- The overall result of the rundown will be reported as a reject.
- The torque and angle status will be reported as evaluated with the following exception:  
If torque and angle are both within limits, the torque and angle status will both be reported as low. This is done to further indicate that the rundown was terminated before completion.

---

## 4.2.5 Default Psets

---

See "3.2 Quick Set Up" on page 7.

---

## 4.2.6 Manage PSets

---

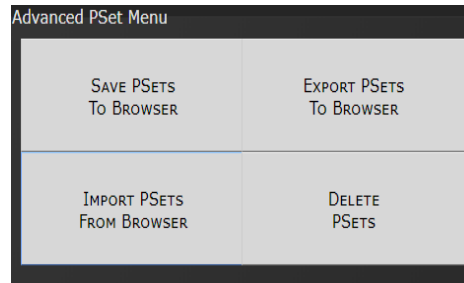

### Save PSets to Browser

Allows the PSet information to be saved to the local PC connected to controller. PSet information is saved as a .txt file and can be opened using any text editor such as WordPad. It can also be opened with Excel. The format of the .txt file is tab separated values.

### Export PSets to Browser

Save the PSets as a database file to the PC connected to controller. These PSets can later be imported to another controller.

### Import PSets from Browser

Import previously exported PSets to controller.

### Delete PSets

Enables deletion of selected PSets.

## 4.2.7 Multistage Rundown Evaluation and Reporting

### If a rundown cycle completes, or is terminated early while in or after the final audit stage of the PSet:

- The overall evaluation of the rundown will be determined using the torque and angle limits set in the final audit stage.
- The peak torque and angle achieved during the rundown, are used for the evaluation and reported.
- The torque and angle status, and overall result reported, will reflect this evaluation.

**Note:** The fastening torque must achieve the In-Cycle torque value set in the PSet for the rundown to be evaluated or reported.

### If a rundown is terminated early before reaching the final audit stage:

- The overall result of the rundown will be reported as a reject.
- The torque and angle evaluation will be determined using the limits set in the stage that was running when the rundown was terminated.
- The torque and angle at the point in time when the rundown was terminated, is used for the stage evaluation.
- The torque and angle status reported will reflect this stage evaluation with the following exception:
  - If torque and angle are both within limits of the stage that was running, or if the stage was a non-audit stage, the torque and angle status will both be reported as low. This is done to further indicate that the rundown terminated before reaching the final audit stage.
- The peak torque and angle achieved during the rundown will be reported.

**Note:** The fastening torque must achieve the In-Cycle torque value set in the PSet for the rundown to be evaluated or reported.

### Unfastening Stage special considerations:

- Rundown Back-Off multi stage PSet (Unfastening as the last stage)
  - If the unfasten stage is set to 'Non Audit':
    - The peak torque and angle reported from the fastening portion of the rundown will be used for the evaluation and reported.
  - If the unfasten stage is set to 'Audit':
    - The final torque and angle in the unfastening direction, at the point in time when the run cycle completes or is terminated, will be used for the evaluation and reported.
    - The final torque and angle will be reported as negative in the unfastening direction.
    - If the rundown cycle is terminated before reaching the final unfastening audit

- stage, the final torque and angle values will be reported as zero and the torque and angle status will be reported as low.
- Rundown Back-Off Rundown multi stage PSet (Unfastening as a middle stage)
  - The value for peak torque in the forward direction, will be reset to zero when tool begins an unfastening portion of the rundown.
  - If the rundown is terminated during the unfastening stage, the final torque and angle values will be reported as zero and the torque and angle status will be reported as low.

### Torque Averaging Stages (AC\_TA and AC\_TCOMP) reporting exception:

- If a torque averaging stage fails to complete, or is the final audit stage, and the peak torque is less than the high torque limit, the final torque reported will be the torque average during that stage.

### Torque and angle measurement details:

- Peak Torque is used for the overall evaluation and reported:
    - The peak torque achieved, from the start of the rundown to the when the torque falls below the cycle complete value set in the PSet
  - Torque is used for the stage evaluation:
    - The torque at the point in time when the stage was terminated or completed
  - Peak Angle is used for the overall evaluation and reported:
    - The peak angle achieved, measured from the angle reference set in the final audit stage, to the when the torque falls below the cycle complete value set in the PSet
- Note:** If an angle reference is not defined in the final audit stage, the angle is measured from when the torque first crosses the In-Cycle torque set in the PSet.
- Angle is used for the stage evaluation:
    - The angle at the point in time when stage was terminated or completed, measured from the angle reference set in the stage.
- Note:** 'Audit Stages' are stages that have torque and angle limits defined. These stages include:
- TC Stage
  - TC\_AM Stage
  - TC\_AC Stage
  - AC\_TM Stage
  - AC\_TA Stage
  - AC\_TCOMP Stage
  - Unfastening Stage (If Audit is selected)

**Note:** If the evaluation of any stage during the rundown fails, or a bail out limit is exceeded, the fastening cycle will be terminated early and any subsequent stages will not run.

## 4.2.8 Multiple Stage Rundown Examples

**EXAMPLE:** Two-stage rundown with downshift

This example shows a typical two stage rundown with a higher first stage free speed and slower down shift speed to minimize overshooting of the target torque.

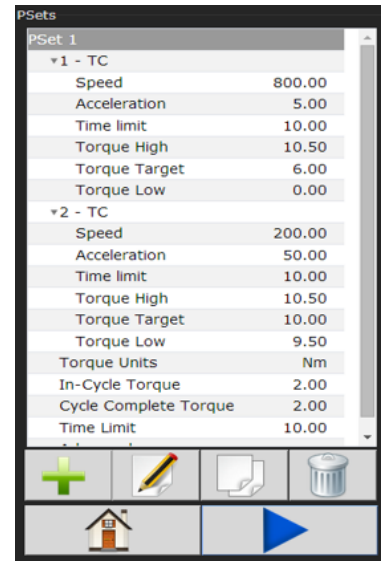
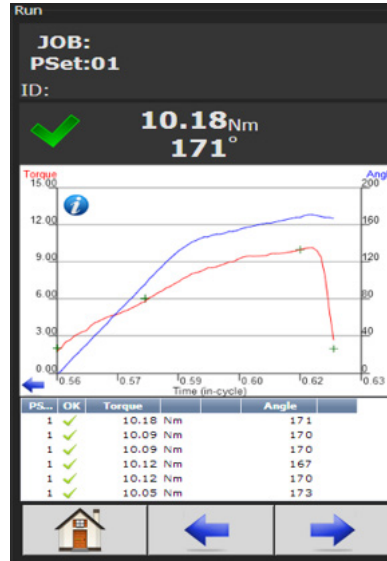

**EXAMPLE:** Three stage rundown with unfasten on the last stage. (Rundown Back-off)

This example shows a typical three stage rundown with a back-off stage at the end of the rundown.

**NOTE:** The unfasten stage's audit parameter is set to false, therefore, the torque and angle reported are from the fastening portion of the rundown.

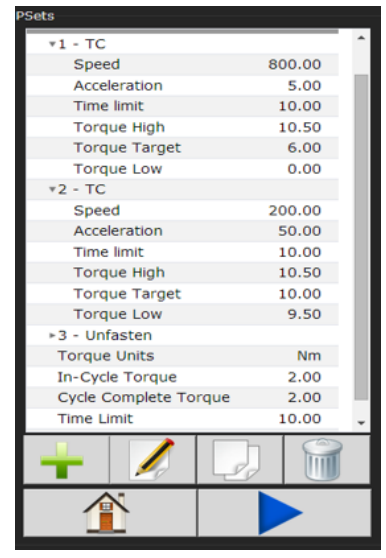
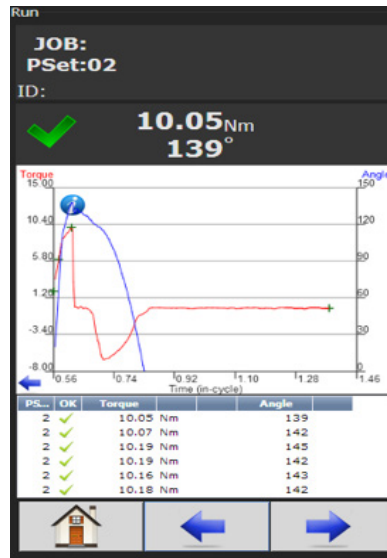

**EXAMPLE:** Four stage rundown with an unfasten stage in the middle. (Rundown back off Rundown)

**NOTE:** The peak torque was reset at the start of the fastening stage. The torque reported was from the final stage.

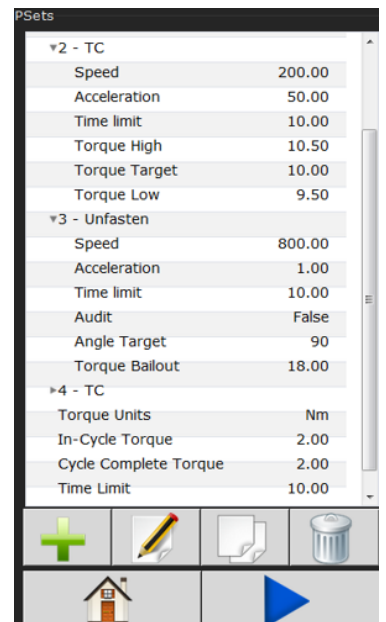
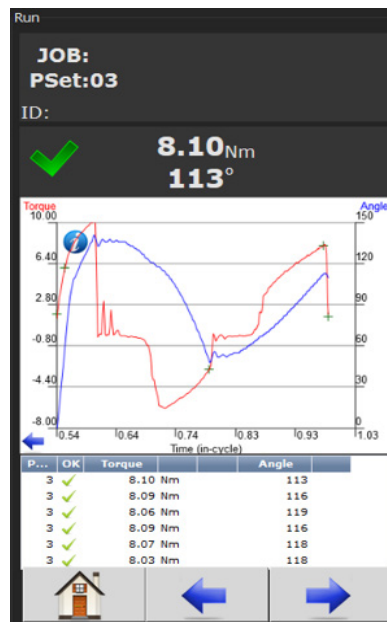

## 4.3 Job

A Job is a collection of PSets which can be run when performing multiple fastening operations on a single application.

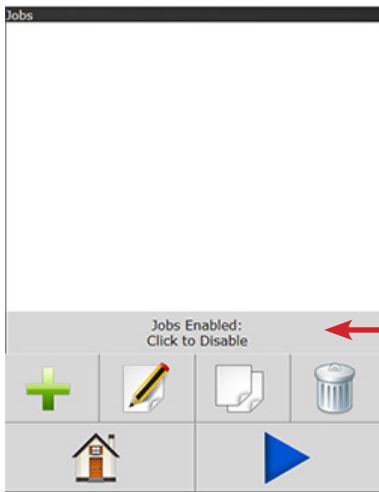

- Jobs provide:
- Error proofing
  - Logical grouping of PSets
  - Fastening order
  - Job status

Click to Enable/Disable Job function.

### 4.3.1 Add New Job

To add a new Job press on the Home Page. Press on Jobs screen (above) to enter Add New Job screen (below)

**Job Number:** Up to 99 Jobs can be configured.

**Job Name:** Enter Job Name

**Job Action:**

- **Disable Tool:** Disable tool after job is finished. Job complete icon will appear.



Tool will not operate until job is reset.

- **Reset Job:** Will reset after Job is finished. Once Reset Job is finished, the following icon appears:



This means that results from the last successful rundown of a job are cleared. Information from last successful rundown can still be

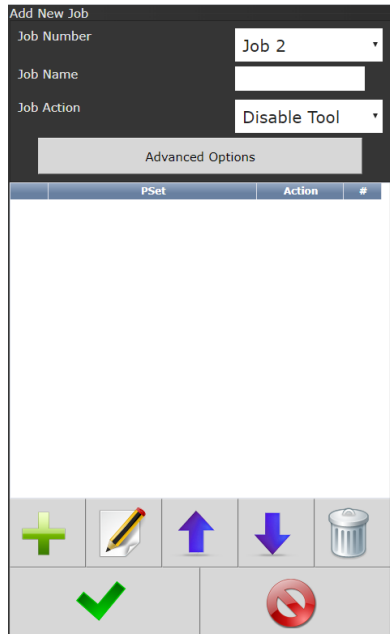

accessed in the Results screen (see "4.4 Results" on page 31).

After appropriate values are entered, press to go to Add New Job Sequence screen.

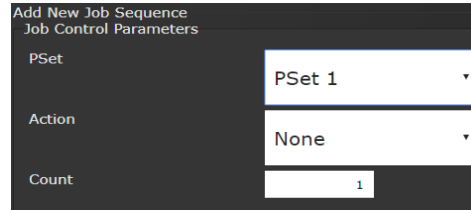

**PSet:** Choose any current PSet already configured in controller

**Action:**

- **None:** Will stay in current sequence.
- **Next:** will advance to next sequence set up after count is reached.

**Count:** Fastener number required to complete sequence.

Once values are entered press two times to return to Job screen

#### 4.3.1.1 Advanced Options

Enter Advanced Options if needed.

**Lock on Reject Parameters:**

- **Enable:** When enabled, this prevents tool from starting a new rundown if the result of the last rundown was a reject. Tool remains locked until one of the four Unlock Mode conditions are satisfied.

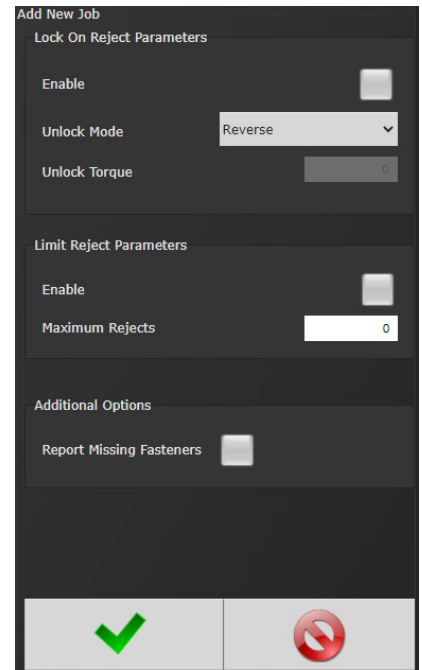

**Unlock Mode:**

- **Reverse:** Running tool in disassembly mode.
- **Reverse and Throttle:** Running tool in disassembly mode.
- **Reverse and Unlock Torque:** Exceeding "Unlock Torque" while tool is in the disassembly direction (backing off a rejected fastener).

- **Any MFB Press:** Pressing MFB button on tool (regardless of MFB configuration).
- **External I/O:** Assignment of "Remove Lock on Reject" will allow for an external Input signal to release the lock condition.

**Unlock Torque:** If Unlock Mode is set to "Reverse and Unlock Torque", this torque value must be exceeded when the tool is in the disassembly direction in order to unlock the tool.

**Limit Reject Parameters:**

- **Enable:** Enable or Disable
- **Maximum Rejects:** Number of rejected fasteners allowed

**Additional Options:**

- **Report Missing Fasteners:** Add an option to each JOB that would allow us to report any missing fasteners. When it is set, the controller will report an NOK rundown for each fastener that is defined in the JOB but has not been run. These NOK results will be reported whenever a new job is started AND the prior JOB is incomplete.

These generated NOK results are treated like any other fastening. They are displayed on the run screen, stored in the results and transmitted on all protocols.

**4.3.2 Jobs "Enabled" Display and Button Function**



- Increment and Decrement buttons change the job sequence. The PSet number will change and job sequence number on secondary display will change if jobs are enabled.

- Holding the toggle button will display will display the Job number, while pressing increment or decrement buttons will change it. The two numbers on the PSet/Job display will be separated by decimals.
- Pressing the toggle button will change secondary display between:
  - Units of measure
  - Ethernet 1 IP address
  - Ethernet 2 IP address
  - System port IP address
  - Angle report
  - Bolt count
  - Job sequence

**NOTE:** Job sequence shows which PSet you are currently on in the job (this is not the pset number). The first pset in the job is always job sequence 1, and the next is 2, etc.

Bolt count is shown as current bolt count out of total number of bolts. Example: If you have 3 total bolts. When you start the job you will see 0.3. After one rundown you will see 1.3 and then 2.3 on the next run and so on until the job is completed.

**4.4 Results**

ID	Time Stamp	PSet	OK	Torque	Angle	Fault
72	08/04 00:26:44	5	✓	1.25 Nm	124°	
71	08/04 00:26:44	5	✓	1.09 Nm	14.0°	
70	08/04 00:26:43	5	✓	1.15 Nm	22.7°	
69	08/04 00:26:42	5	✓	1.28 Nm	22.2°	
68	08/04 00:26:41	5	✓	1.26 Nm	207°	
67	08/04 00:26:39	4	✓	15.49 Nm	221°	
66	08/04 00:26:37	4	✓	15.26 Nm	218°	
65	08/04 00:26:34	4	✓	16.33 Nm	2.4°	
64	08/04 00:26:31	5	✓	1.53 Nm	22.7°	
63	08/04 00:26:30	5	✓	1.60 Nm	32.3°	
62	08/04 00:26:30	5	✓	1.51 Nm	19.3°	
61	08/04 00:26:29	5	✓	1.13 Nm	242°	
60	08/04 00:26:28	5	✓	1.13 Nm	250°	

This screen provides a history of rundowns performed. Information such as ID Number, Time Stamp, Parameter Set#, Accept / Reject status, and Torque and Angle are recorded for each rundown.

	Filter Button gives filter options in Rundown screen.
	Save Button saves rundowns as .Txt File.
	Deletes individual rundowns by clicking on them

 **Select Columns Button** lets you customize the columns shown on the Results Screen

**Select Columns**

Rundown ID  Timestamp

PSet  OK/NOK

Torque  Angle

Pulses

Barcode ID #1  Barcode ID #2

Barcode ID #3  Barcode ID #4

Stopped  Aborted

Faulted

 **Home Button** returns to main display menu.

 **Play Button** sends you directly to Run Screen.

 **Refresh Button** refreshes screen to include latest rundowns.

ID	Time Stamp	PS...	OK	Torque	Angle
112	01-01 02:29:00	1	✓	12.03 Nm	124
111	01-01 02:28:56	1	✓	11.98 Nm	124
110	01-01 02:28:50	1	✓	12.02 Nm	112
109	01-01 02:28:46	1	✓	11.63 Nm	113
108	01-01 02:20:13	1	✗	2.56 Nm	34

Click on Individual Runs for Rundown information.

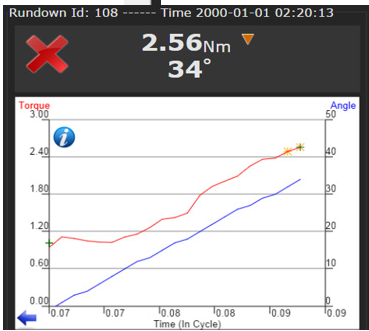

Example: Rejected Rundown Information.

## 4.4.1 Saving Rundown(s)

### Saving All Rundowns

Click on  in main rundown screen to view/save total rundowns. A dialog box will open that allows you to choose the download format, either a CSV file or a TW4 file. The CSV file includes rundown data in tab separated variables and can be viewed using Excel or opened in text editor such as Notepad. The raw data can be imported to Excel to build graphs, charts etc. Contact AIMCO Technical Service for pre-made Torque and Angle Templates.



The TW4 file can be opened using the ACE Platform G4 Utility located on the [software page](#) of the AIMCO website.

**Save Results**

File Type: CSV

Include Stage Results:

Include Log Entries:

The dialog box also shows options for including stage results or log entries in the downloaded file. If downloading a TW4 file, all information will be automatically selected.

Click  and your browser will download the file.

### Saving Individual Rundowns

ID	Time Stamp	PS...	OK	Torque	Angle
490	01-01 01:01:28	1	✓	15.69 Nm	3
489	01-01 01:01:27	1	✓	15.33 Nm	3

To save an individual rundown, select a

rundown from the Results screen.

This opens the Rundown Information View. Click on  to save the rundown. The file will automatically download as a CSV file.

### Rundown Information View

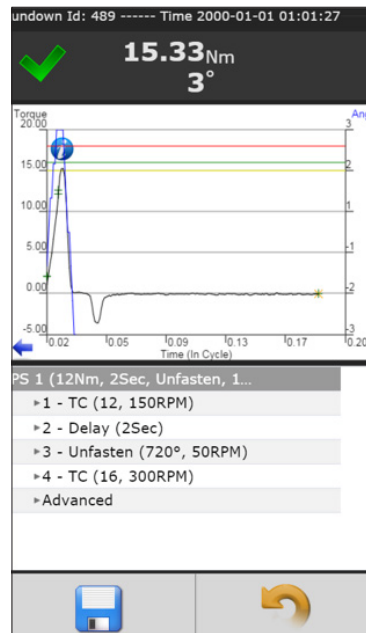

### Sample of Individual Rundown Information

1	Result	65
2	Job Num	1
3	Job Name	Paramont
4	Job Sequ	1
5	Bolt Coun	3
6	Date	##### 4:18:00
7	Master Ru	0
8	PSet ID	59
9	PSet Num	1
10	PSet Name	
11	Tool Mod	AEN32030A
12	Tool Seria	191111
13	Torque	11.69
14	Angle	57
15	Pulses	0
16	Torque St: P	
17	Angle Stat--	
18	Pulse Stat--	
19	Rundown P	
20	Tool Cycle	1111
21	ID1 ("ID #1)	2.2E+10
22	ID2 ("ID #2)	4.86E+10
23	ID3 ("ID #3")	
24	ID4 ("ID #4")	
25		
26		
27		
28	Curves	
29	Tick	Torque Angle
30	0	0.02 0
31	1	0.02 0
32	2	0.05 0
33	3	0.04 0
34	4	0.09 0



## 4.5 Controller

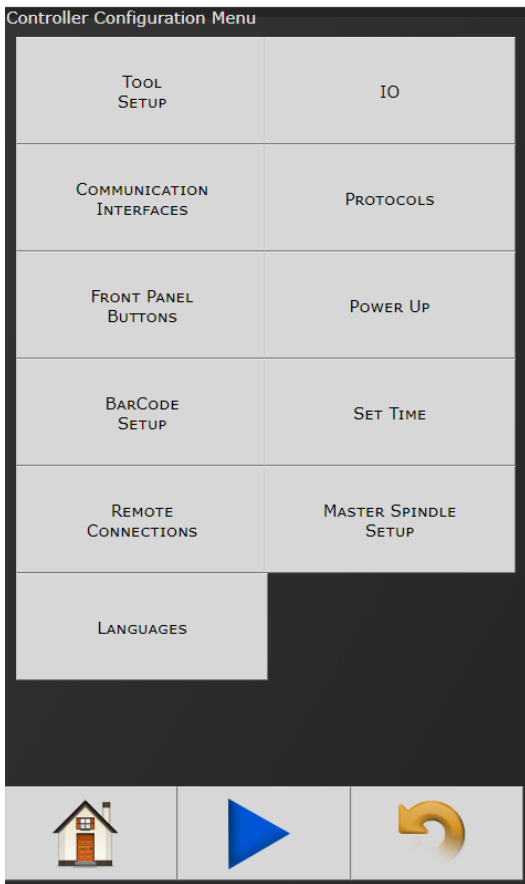

The controller menu is where all of the settings for the Gen IV controller are configured. All of the different configuration capabilities are explained below.

### 4.5.1 Tool Setup

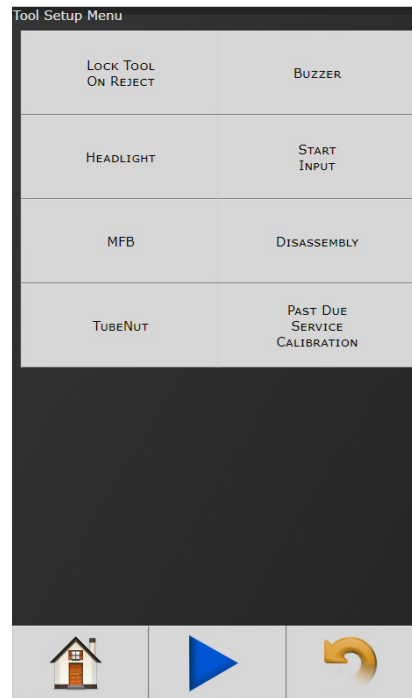

In this screen user can enable/disable various tool functions.

#### 4.5.1.1 Lock Tool On Reject

When enabled, this prevents tool from starting a new rundown if the result of the last rundown was a reject. Tool remains locked until one of the four Unlock Mode conditions above are satisfied.

**Unlock Mode:** The action that re-enables the tool for use.

- **Reverse:** Running tool in disassembly mode.
- **Reverse and Throttle:** Running tool in disassembly mode.
- **Reverse and Unlock Torque:** Exceeding "Unlock Torque" while tool is in the disassembly direction (backing off a rejected fastener).
- **Any MFB Press:** Pressing MFB button on tool (regardless of MFB configuration).
- **External I/O:** Assignment of "Remove Lock on Reject" will allow for an external Input signal to release the lock condition

**Unlock Torque:** If Unlock Mode is set to "Reverse and Unlock Torque", this torque value must be exceeded when tool is in the disassembly direction in order to unlock tool.

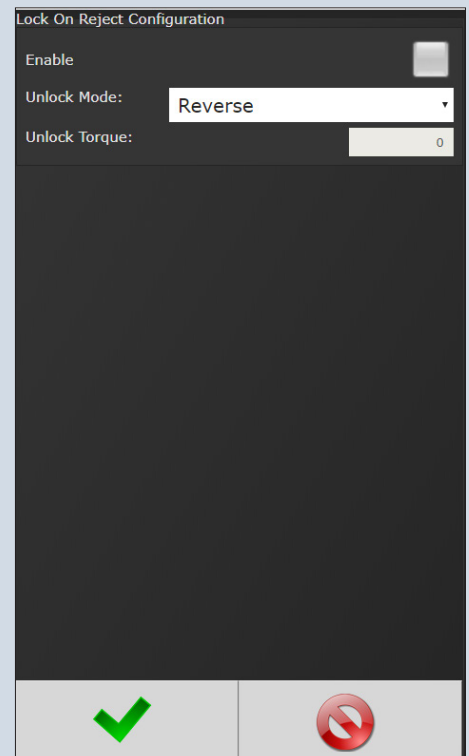

## 4.5.1.2 Buzzer

Set the way the buzzer behaves in OK/NOK situations. Menu options are

- Silent
- Constant
- Beep

If a rundown is rejected, the beeping can be stopped by making a successful rundown or by using the MFB.

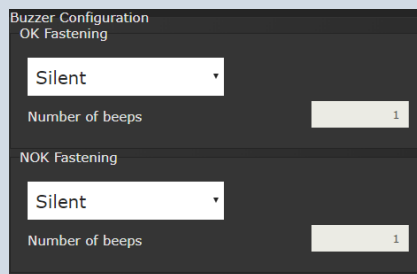

## 4.5.1.3 Headlight

**Headlight Enable:** Enables or Disables the Headlight (pistol style tools only).

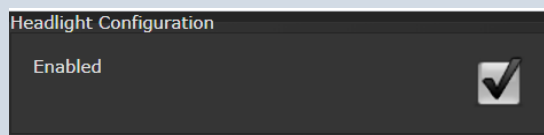

## 4.5.1.4 Start Input

**Start from IO:** Start tool through I/O from external source.

**Start From Tool Buttons:** Normal operating condition: Tool lever and MFB control tool operation.

**Start From Master Tool:** Used when one tool's start lever in the multispindle machine will be used as the start command for the entire system

**Start From Remote Start:** Used when the system start command would come over the Eth port connection

**Tool Throttle Configuration:** Four options are available:

- **Lever or PTS (Push to Start):** This the default configuration. Pressing either the Lever or PTS will start the tool.
- **Lever and PTS (Push to Start):** Both the Lever and the PTS need to be pressed in order to start the tool.
- **Lever:** Only the Lever will start the tool.
- **PTS:** Only the PTS will start the tool.

**Latching Options:**

- **Not Latched:** Start Input is not latched.
- **Latched on Time:** Start Input latches if lever is pressed for a set time.
- **Latched on MFB:** Latches on the following sequence:
  - Press and hold lever.
  - Press MFB while lever is still being held down.
  - Release the lever.
  - Release the MFB.

**Latch Hold Time (s):** Amount of time (in seconds) the lever needs to be depressed to latch throttle (if Latched on Time is selected above).

**NOTE:** Throttle will unlatch automatically at the end of the rundown or when the lever is repressed. If the tool is installed with dual levers requiring two-handed operation, the above Start Input Configuration settings will be ignored (see Dual Lever Two Handed Tools section).

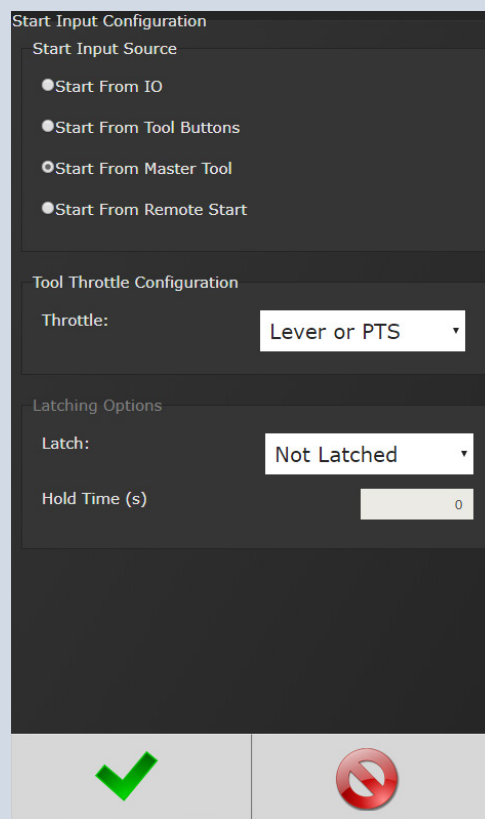

## 4.5.1.5 MFB (Multi-Function Button)

The MFB Mode configures the multiple function button for handheld AcraDyne tools. The button can be configured to operate in any of the following modes:

**Tap Mode:** Actions will commence if MFB is held less than hold time.

- **Disabled:** MFB button will not work.
- **Disassembly Toggle:** Depress the MFB each time to switch between forward and reverse.
- **Disassembly One Shot:** Tool will automatically return to forward after fastening. The MFB will NOT have to be depressed for forward operation.
- **Change PSET:** Tapping MFB button toggles between PSet A and PSet B. Status lights flash once indicating PSET A is selected twice indicating PSET B is selected.
- **Change Job:** Tapping MFB button changes jobs.
- **Arming:** Tapping MFB button arms (activates) the Start function but does not start the tool. Blue status light illuminates indicating tool is Armed. Arming resets in three seconds if tool Start is not initiated.
- **Stop Reject Tone:** Tapping MFB silences the audible reject tone.
- **Increment PSET Number:** Tapping MFB will switch upward to next PSet.
- **Increment Job Number:** Tapping MFB switches upward to next Job.
- **Increment Job Sequence:** Tapping MFB switches to next PSet in the current Job.

**Tap A Parameter:** Assign a specific PSet (Job) to the "A" parameter, toggle back and forth between "A and "B" parameters using MFB.

**Tap B Parameter:** Assign a specific PSet (or Job) to the "B" parameter.

**Hold Time (s):** Amount of time (in seconds) required to hold the MFB until Hold Action is triggered.

**Hold Mode:** Actions will commence after Hold timer preset time has elapsed (Adjustable in Hold Time window). Default value is one second.

**NOTE:** The same options are available in Hold mode as in Tap mode.

The screenshot shows the 'MFB Configuration' menu with the following settings:

- Tap Mode: Disassembly Toggle
- Tap A Parameter: 1
- Tap B Parameter: 2
- Hold Time (s): 1
- Hold Mode: Disabled
- Hold A Parameter: 1
- Hold B Parameter: 2
- Arming Timeout (s): 3

At the bottom of the screen, there are two buttons: a green checkmark icon on the left and a red prohibition sign icon on the right.

## 4.5.1.6 Disassembly

**Overall Timeout (s):** Total amount of time, in seconds, after throttle is depressed that tool will operate.

**Speed (RPM):** Maximum speed of the Output spindle.

**Acceleration (kRPM/s):** Rate at which tool is set to ramp up to maximum RPM.

**Enable on Reject Only:** If enabled, this option will only allow the tool to be placed in disassembly after a rejected fastening.

**Report Disassembly:** If enabled, disassembly events will be reported and logged.

**Threshold Torque:** Disassembly will be reported only if this torque value is reached. This is entered as a positive value.

**Torque Units:** Units for the Disassembly Threshold Torque

**Decrement Fastener Count:** If Disassembly is detected the fastener count in JOBS

- **Never:** Decrement count will be ignored
- **Always:** Decrement will always be active
- **Only after NOK:** Decrement only occurs after a tightening has been judged to be NOK (Reject)

**Discontinuous Settings:** For a description of these options, see "Discontinuous Mode Parameters" on page 11

### When a disassembly event is reported:

The disassembly will be displayed on the run screens and logged in the rundown record, containing the following:

- Overall evaluation will be marked as 'Disassembled' Peak torque during the disassembly (torque shown as negative).
- Peak overall angle during the disassembly (angle shown as negative).
- Curve data from the disassembly
- Parameters from the current PSet selected
- Fastening events from the disassembly.

All of the controller's status LEDs will be turned OFF. The LED display will show peak torque and angle as negative

### I/O Considerations:

When disassembling, all assignable IO outputs that report rundown status will remain in the state from the last fastening cycle. This includes:

- Ok and Nok signals
- Torque/Angle high or low signals
- Torque and Angle Values

All assignable I/O outputs reporting a fastening events will not change state during the disassembly. This includes:

- Fastening Complete
- In Cycle
- Fastening Stopped
- Fastening Aborted

**NOTE:** When the tool is placed into disassembly mode, all of the tool's LEDs flash and the Horn beeps. This will continue until the tool is placed back into fastening mode.

## 4.5.1.7 Tubenut

**Trigger Action:** Two options are available

- **Release and Repress:** Socket will return Home on release and repress of main lever.  
**NOTE:** If the main lever is released while homing in this configuration the tool will stop and will continue to Home once the lever is repressed.
- **Release:** Socket will return Home upon release of main lever.

**Speed (RPM):** The speed in RPMs which a tubenut tool will return to the open position (default 50 RPM).

**Acceleration (kRPM/s):** Rate at which tool is set to ramp up to maximum homing RPM.

**Reverse Dwell Time (s):** Amount of time (in seconds) before Output attempts to return Home, after Home command is initiated (default 500ms).

**Hold at Home Dwell Time (s):** Amount of time (in seconds) Output is held at Home position (default 500ms).

### Retry Home when Disabled:

This will allow a retry of the tube-nut homing sequence (by releasing then repressing the lever) even if the controller has been disabled or the stop input is on.

**NOTE:** Output is held at Home for the Home Dwell Time to prevent socket from bouncing back to partially closed position.

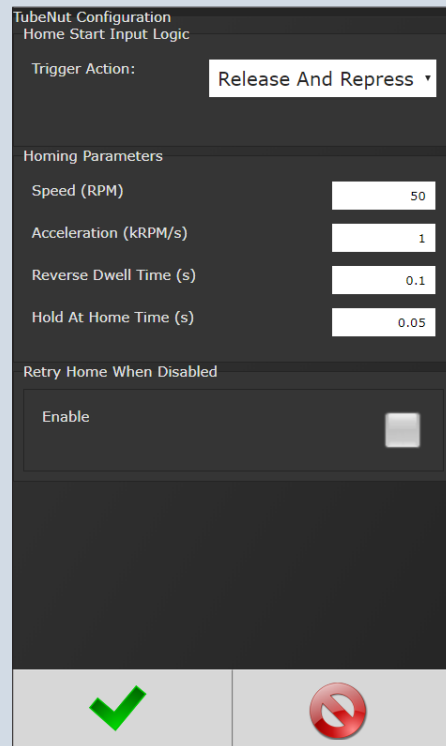

## 4.5.1.8 Past Due Service Calibration

**Service Past Due:** Four options are available:

- **No Action:** No Action will be taken.
- **Log Error:** Errors will be saved on Service Log.
- **Display Error:** Calibration/Service message will appear on screen between each rundown. Tool remains functional.
- **Disable Tool:** Disable tool in preset Service period. Exceeded (date/time) LED warning appears on the controller.

**Calibration Past Due:** Same options as above

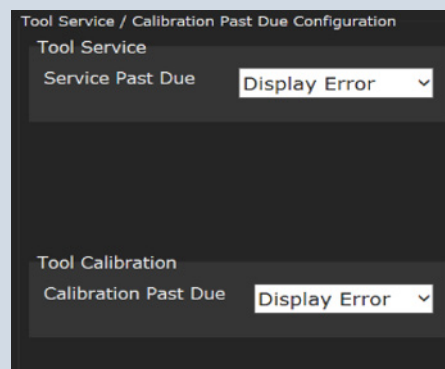

## 4.5.2 IO

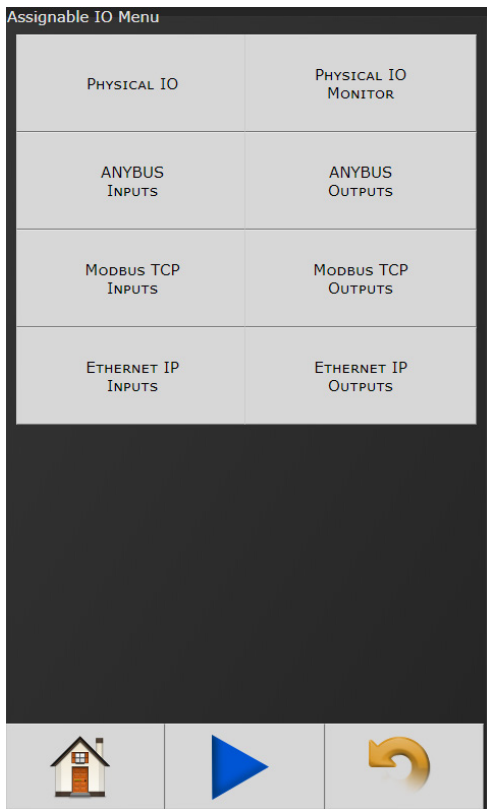

**NOTE:** See "12. Assignable I/O" on page 68 for details.

### 4.5.2.1 Physical IO

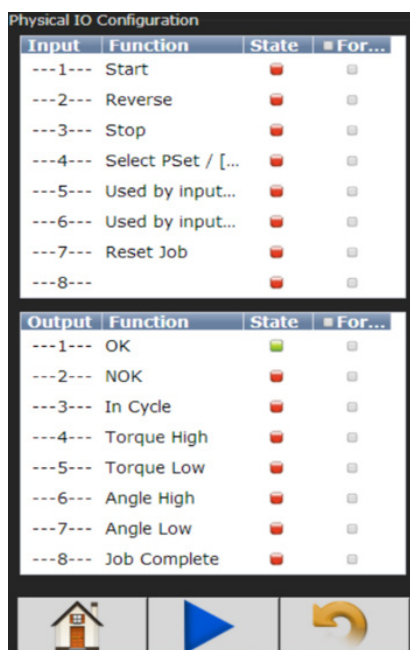

Assign functionality to 24V Input and Output pins. Shows the "live state" of each Input and Output.

Functions shown in screen shot are default settings.

To change these assignments, click on any I/O state to enter Output/Input Configuration screen (following).

### Input Configuration

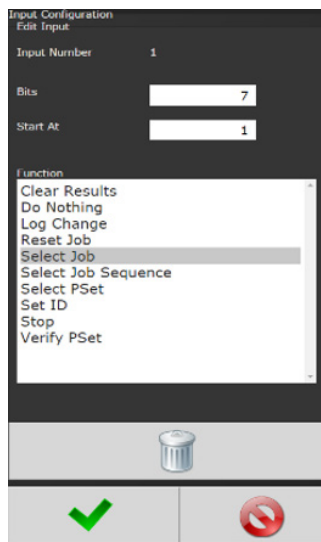

### Output Configuration

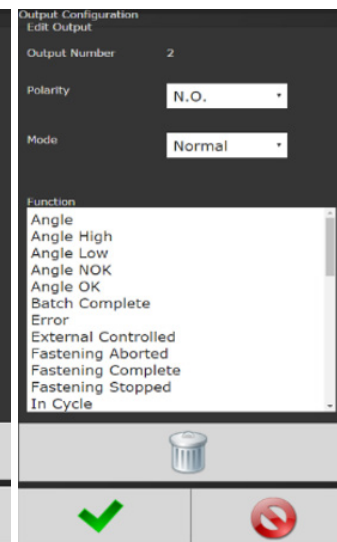

See "12. Assignable I/O" on page 68 for more details on available assignment functions and how to configure.

See "11. 24 Volt I/O" on page 66 for the pinout of the 24Volt Logic IO port, and wiring examples.

### 4.5.2.2 Physical IO Monitor

Provides monitoring of Physical 24 Volt I/O. Force on/off the individual I/O pins for testing of field wiring.

Each indicator shows the state of the associated pin.  
Green = On  
Red = Off

- Force:** When Buttons from I/O are selected, this field selects which Inputs and Outputs can be forced through the Monitor I/O screen.
- Off/On:** If Force is enabled this button will toggle the state of pin selected.

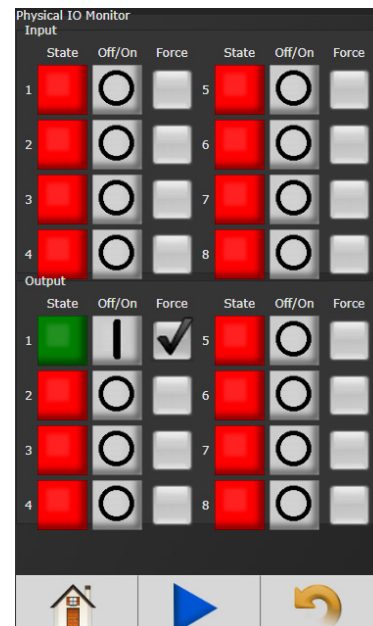

### 4.5.2.3 Anybus/Modbus TCP/Ethernet IP Inputs

These types of communication are useful for data communication between controller and PLCs. It is an effective, quick way for the data transfer of short data packages.

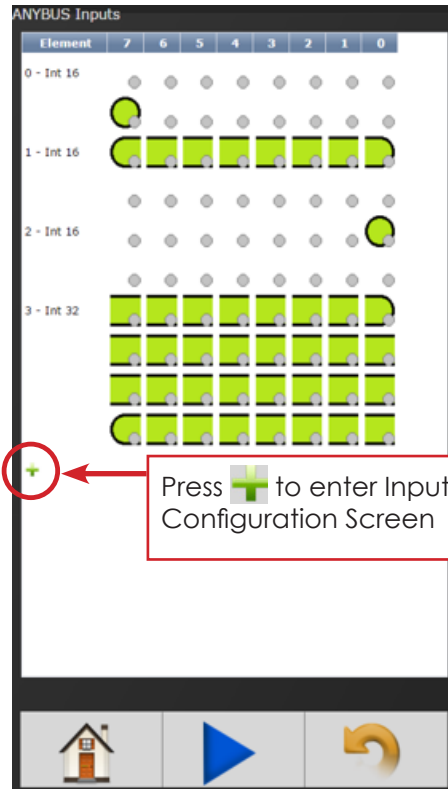

Press to enter Input Configuration Screen

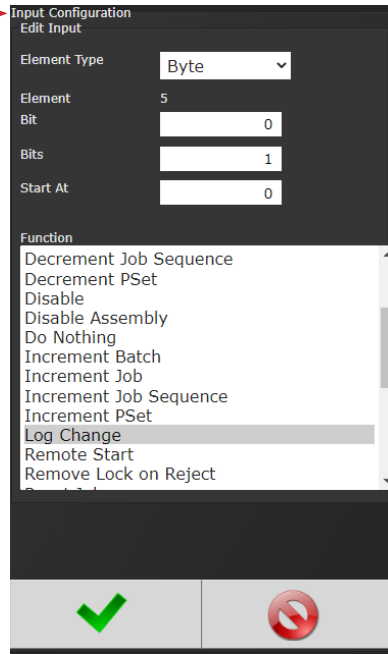

**Element Type:** Choose from Byte, Int16, Int32, or ASCII.

**Element:** Shows element # being configured

**Bit** (not shown): Enter Bit #.

**Bits:** # of bits the assignment will read.

**Start at:** Starting bit location.

**Polarity** (not shown): Select Normally Open (N.O.) or Normally Closed Outputs (N.C.).

**Length** (not shown, available in ASCII ID function): Number of characters desired to send.

**Torque** (not shown, available in Click Wrench function): Torque value to be reported when using Click Wrench input. Value input is what will be sent from controller when Input Signal is received from a Click Wrench. **Value is NOT calculated by the controller rather it is solely what the Click Wrench is calibrated to by outside means.**

**Torque Units** (not shown, available with Click Wrench function): Choose from Nm, Kgm, Kgcm, Ftlb, and Inlb.

**Function:** See "12. Assignable I/O" on page 68 for details. Select desired Input Function(s).

Click on after appropriate selections are made.

Example of the Anybus Input screen with five Inputs set up.

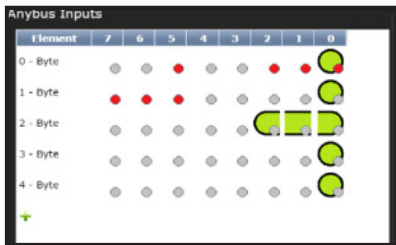



Click on to change an individual Element or return to Input Configuration screen.

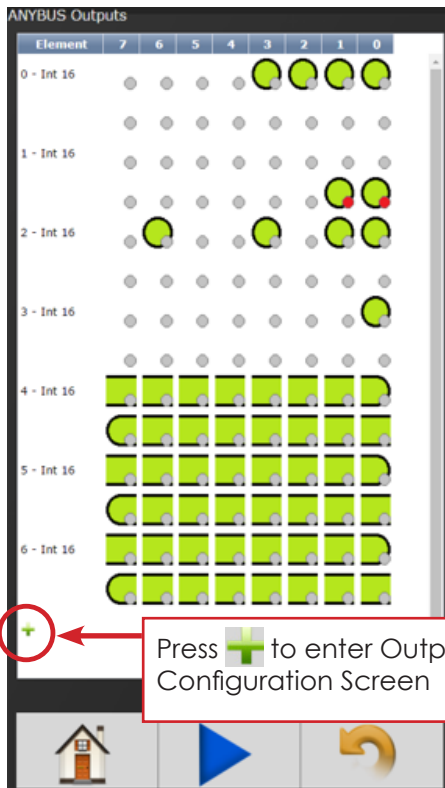

Will delete individual Elements.

## 4.5.2.4 Anybus/Modbus TCP/Ethernet IP Outputs



Press  to enter Output Configuration Screen

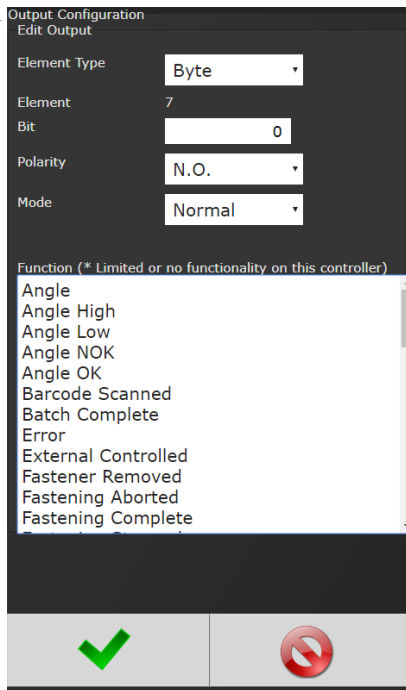

**Element Type:** Choose from Byte, Int16, Int32, or ASCII.

**Element:** Shows element # being configured

**Bit:** Enter Bit #.

**Bits (not shown):** # of bits the assignment will read.

**Start at:** Starting bit location.

**Polarity:** Select Normally Open or Normally Closed Outputs.

**Mode:**

- **Normal:** Output signal sent.
- **Timed Signal Sent:** Time entered in seconds
- **Flash Signal Sent:** Time entered in seconds

**Function:** See "12. Assignable I/O" on page 68 for more details on assignable functions.

Click on  after appropriate selections are made.

Example of the Anybus Output screen with five Outputs set up.

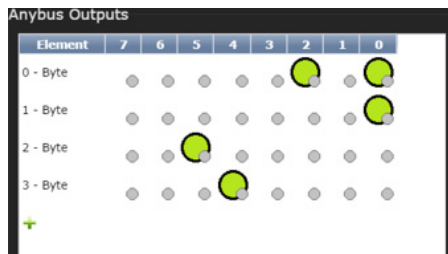

Click on  to change an individual Element or return to Input Configuration screen.



Will delete individual Elements.



## 4.5.3 Communication Interfaces

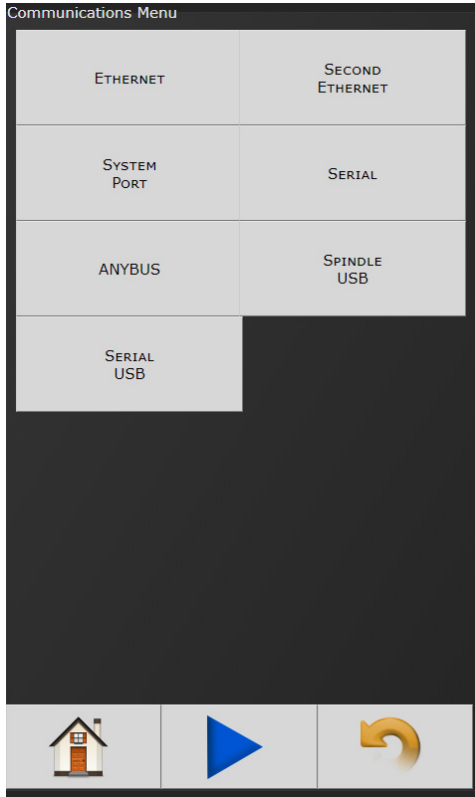

### 4.5.3.1 Ethernet/Second Ethernet

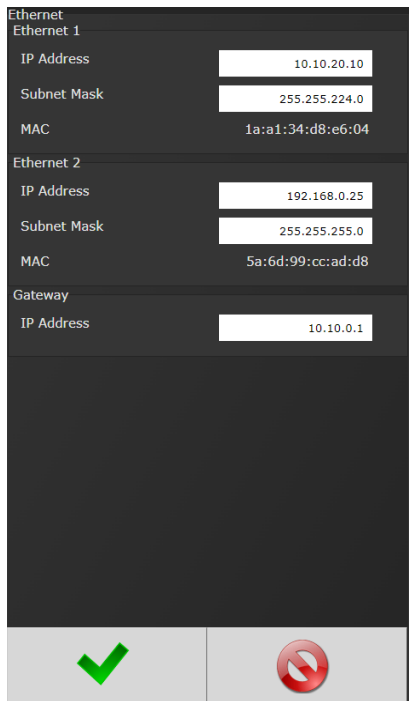

**IP Address:** IP address of controller's Ethernet port.

**Subnet Mask:** Subnet mask of the controller.

**Gateway:** Gateway is the IP address of the gateway computer that provides access beyond the local network.

**NOTE:** Consult your local System Administrator to connect the controller to your Network and assign IP addresses.

### 4.5.3.2 System Port

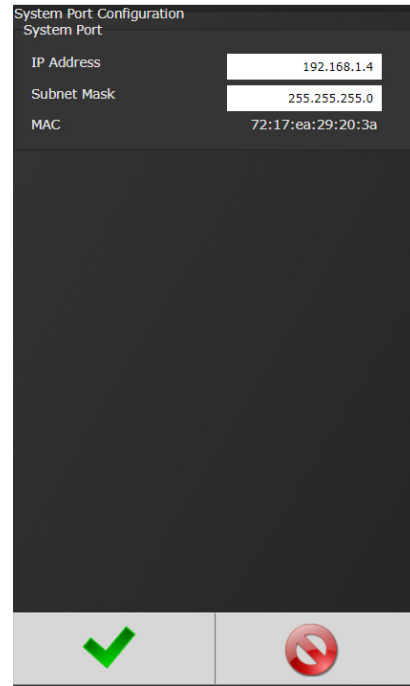

**IP Address:** The IP address of controller's System Port (Default is 192.168.1.4)

**Subnet Mask:** The Subnet Mask of controller's System Port.

**NOTE:** It is not recommended to change this setting.

### 4.5.3.3 Serial Port

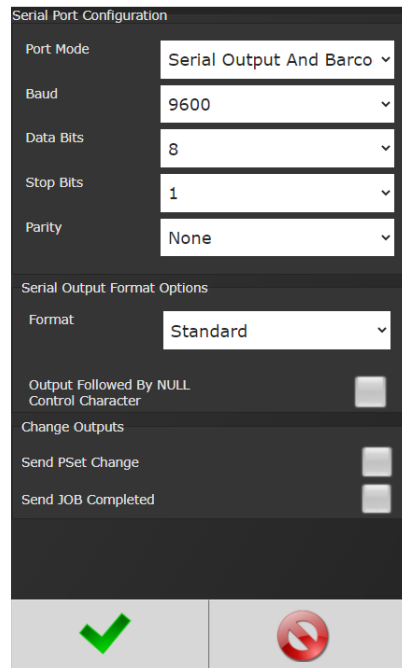

**Port Mode:** The following modes are available:

- **Serial Output:** A serial data string will be Output in the following format after each rundown:
  - # P 1 BB TTT.T AAAA 0000 0000 J  
(Notice the decimal point next to the least significant T)

- P: Parameter set ("1" – "9") for PSets 1-9, ("A" – "W") for PSets 10-32.
- B: Job count
- T: Torque result
- A: Angle result
- J: Judgment
  - @=overall pass, H=low torque, I (eye)=high torque, J=low angle, K=high angle, G=fault during fastening
- **Barcode Reader:** See "5. Barcode Reader Details" on page 58 for Barcode setup.
- **Serial Output and Barcode Reader:** Select from dropdown and configure per hardware requirements
- **Open Protocol:** Select from dropdown and configure per hardware requirements
- **PFCS:** Select from dropdown and configure per hardware requirements
- **PI Line Control:** This is customer specific. Please reference PI Line Control Document on [AIMCO Website/Manuals](http://AIMCO Website/Manuals).

**Baud:** Serial ports can be configured for different baud rates available.

- 75, 110, 300, 1200, 2400, 4800, 9600, 19200, 38400, 57600, 115200

**Data Bits / Stop Bits / Parity:** Configure per hardware requirements

**Serial Output Formats:** See "Serial Output Format Options" on page 43 for details.

- Standard
- Standard with PSet
- UEC Serial Modified
- Profibus
- UEC Serial
- CVS String

**Output Followed by Null Control Character:** Adds a one-byte NULL character to the end of the serial string. Needed by systems that use the NULL character to signify the end of the string. See following section for more information.

**Send PSet Change**

- Sends a serial string any time the PSet is changed. String is in the form '%CAN8X%%CAN4YNAC%' where X is the previous pset and Y is the new pset. See following section for more information.

**Send Job Completed:**

- Sends a serial string containing "Job Completed" whenever a job has been completed.

**Gen IV Serial Port Pin-out**

Pin	Signal
1	
2	RX
3	TX
4	DTR
5	GND
6	
7	
8	
9	

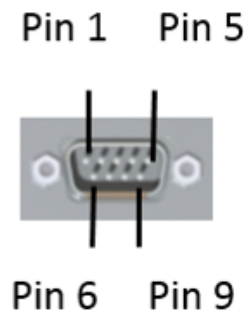

**4.5.3.4 Anybus**

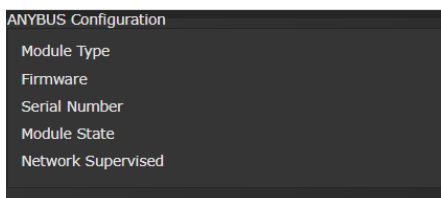

Displays when the controller is AnyBus-enabled by hardware

**4.5.3.5 Spindle USB Port**

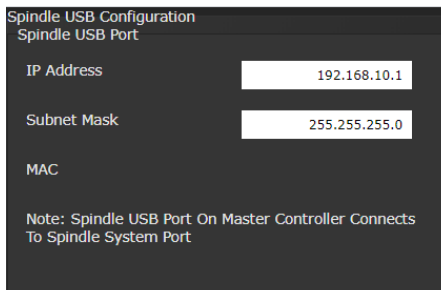

This can be used to set up a 2 spindle network through the USB port.

## Serial Output Format Options

### Standard Output Format:

- ○ P HHHHH LLLLL TTTT P HHHHH LLLLL AAAAA CR CR NULL\*
  - O: Overall Pass/Fail
    - 'P' = Pass, 'F' = Fail
  - P: Torque Pass/Fail
    - \* 'P' = Pass, 'F' = Fail
  - HHHHH: Torque High Limit
    - Units selected in the PSet X10
  - LLLLL: Torque Low Limit
    - \* Units selected in the PSet X10
  - TTTT: Torque Result
    - Units selected in the PSet X10
  - P: Angle Pass/Fail
    - 'P' = Pass, 'F' = Fail
  - HHHHH: Angle High Limit
    - Degrees
  - LLLLL: Angle Low Limit
    - Degrees
  - AAAAA: Angle Result
    - Degrees
  - CR: Carriage return control character
  - CR: Carriage return control character
  - NULL\*: Null control character (\*if option is selected)

### Standard Output with Carriage Return, Line Feed and PSet Format:

- ○ P HHHHH LLLLL TTTT P HHHHH LLLLL AAAAA 1 CR LF NULL\*
  - O: Overall Pass/Fail
    - 'P' = Pass, 'F' = Fail
  - P: Torque Pass/Fail
    - 'P' = Pass, 'F' = Fail
  - HHHHH: Torque High Limit
    - Units selected in the PSet X10
  - LLLLL: Torque Low Limit
    - Units selected in the PSet X10
  - TTTT: Torque Result
    - Units selected in the PSet X10
  - P: Angle Pass/Fail
    - 'P' = Pass, 'F' = Fail
  - HHHHH: Angle High Limit
    - Degrees
  - LLLLL: Angle Low Limit
    - Degrees
  - AAAAA: Angle Result
    - Degrees
  - 1: PSet
    - PSet('1' - '9') for PSets 1-9, ('A' - 'Z') for PSets 10-35
  - CR: Carriage return control character
  - LF: Line feed control character
  - NULL\*: Null control character (\*if option is selected)

### UEC Serial Modified Format (matches some Gen4 earlier versions):

- # P 1 BB TTT.T AAAAA PPPP 0000 J CR NULL\*
  - #: Message Start
  - P: PSet
    - PSet('1' - '9') for PSets 1-9, ('A' - 'Z') for PSets 10-35
  - 1: Spindle Number (Always 1)
  - BB: Job Bolt Count
    - Total number of accepts during the Job
  - TTT.T: Torque Result
    - Units selected in the PSet
  - AAAAA: Angle Result
    - Degrees
  - PPPP: Pulse Count
  - 0000
  - J: Judgment
    - '@' = Overall Pass, 'H' = Low Torque, 'I' = High Torque, 'J' = Low Angle, 'K' = High Angle, 'G' = Fault During Fastening
  - CR: Carriage return control character
  - NULL\*: Null control character (\*if option is selected)

### Profibus Output Format:

- %CAN 1 O P HHHHH LLLLL TTTT P HHHHH LLLLL AAAAA NAC% CR LF NULL\*
  - %CAN: Message Start
  - 1: PSet
    - \* PSet('1' - '9') for PSets 1-9, ('A' - 'Z') for PSets 10-35

- O: Overall Pass/Fail
  - \* 'P' = Pass, 'F' = Fail
- P: Torque Pass/Fail
  - \* 'P' = Pass, 'F' = Fail
- HHHHH: Torque High Limit
  - \* Units selected in the PSet X10
- LLLLL: Torque Low Limit
  - \* Units selected in the PSet X10
- TTTT: Torque Result
  - \* Units selected in the PSet X10
- P: Angle Pass/Fail
  - 'P' = Pass, 'F' = Fail
- HHHHH: Angle High Limit
  - Degrees
- LLLLL: Angle Low Limit
  - Degrees
- AAAAA: Angle Result
  - Degrees
  - NAC%: Message End
- CR: Carriage return control character
- LF: Line feed control character
- NULL\*: Null control character (\*if option is selected)

### UEC Serial Format (matches UEC 4800 and Gen3):

- # 1 P BB TTT.T AAAAA PPPP 0000 J CR NULL\*
  - #: Message Start
  - 1: Spindle Number (Always 1)
  - P: PSet
    - \* PSet('1' - '9') for PSets 1-9, ('A' - 'Z') for PSets 10-35
  - BB: Job Bolt Count
    - \* Total number of accepts during the Job
  - TTT.T: Torque Result
    - \* Units selected in the PSet
  - AAAAA: Angle Result
    - \* Degrees
  - PPPP: Pulse Count
    - L = Low Pulse Count, M = High Pulse Count
  - 0000
  - J: Judgment
    - \* '@' = Overall Pass, 'H' = Low Torque, 'I' = High Torque, 'J' = Low Angle, 'K' = High Angle, 'G' = Fault During Fastening, '\*' = None of these conditions apply
  - CR: Carriage return control character
  - NULL\*: Null control character (\*if option is selected)

### 'CSV String'

- S01,JB01, TTT.T, S, AAA.A, S, O, MM/DD/YYYY HH:MM:SS, VVV<CR><LF>
  - S01: Spindle number
  - JB01: Job number
  - TTT.T: Torque
  - S: Torque Status (A = OK, H = High, L = Low)
  - AAA.A: Angle
  - S: Angle Status (A = OK, H = High, L = Low)
  - O: Overall Status (A = OK, R = NOK)
  - MM: Month
  - DD: Day
  - YYYY: Year
  - HH: Hour
  - MM: Minute
  - SS: Second
  - VVV: 32 character barcode ID
  - <CR>: Carriage Return
  - <LF>: Line Feed

### 'Output Followed by NULL Character'

- The NULL characters can be seen by using PUTTY and connecting to the controller in 'Raw' mode. Then set logging to log all output and check the log to see the NULL characters.

### 'Send PSet Change'

- PSets up to 9 match the number, 10-35 are A-Z, greater than 35 is '\*':
  - %%CAN8X%%CAN4YNAC%%
  - X: Last PSet
  - Y: New PSet

## 4.5.3.6 Serial USB

Serial Port Configuration

Port Mode: Serial Output And Barco

Baud: 9600

Data Bits: 8

Stop Bits: 1

Parity: None

Serial Output Format Options

Format: Standard

Output Followed By NULL Control Character:

PSet Change Output

Send PSet Change:

Status: Port is not connected

See "4.5.3.3 Serial Port" on page 41 for reference

## 4.5.4 Protocols

Protocols Menu

OPEN PROTOCOL	PFCS
TOOLSNET	TELNET
XML	FTP CLIENT

For information about these settings, see individual protocol instructions on AIMCO's website at [www.aimco-global.com/manuals](http://www.aimco-global.com/manuals).

## 4.5.5 Front Panel Buttons

Enable / Disable Front Panel Buttons

Enabled

Enable/ Disable front panel buttons on controller console.

## 4.5.6 Power Up

Allows user several "Job" choices upon controller Power Up:

Power Up Parameters

Power Up Job Number

Job Number: Last Job

Power Up Job Action

Job Action: Reset Job

### Power Up Job

**Number:** Controller will power up on the job # selected.

- **Last Job:** When "Last job" is selected, controller will power up on last job selected prior to being Powered Down.

### Power Up Job Action

- **Reset Job:** Job will be reset when controller is Powered Up.
- **Wait for Job Reset:** Controller will wait for an External Job reset command upon Power Up and will retain job information existing prior to power down.
- **Resume Last Job:** Upon Power Up, tightening sequence will resume at the next fastening from the point in the job when power was shut down.

## 4.5.7 Bar Code Setup

**Required Identifiers for Tool Enable:** Selects which four Identifiers (ID#1-4) are required to enable tool.

**Reset identifiers for Job Complete:** Selects which four Identifiers (ID#1-4) to reset on a job complete. Select Identifiers by clicking on them.

**Block New Identifiers While Job is Running:** Check to enable feature that ignores any barcode scanning while a JOB is in progress

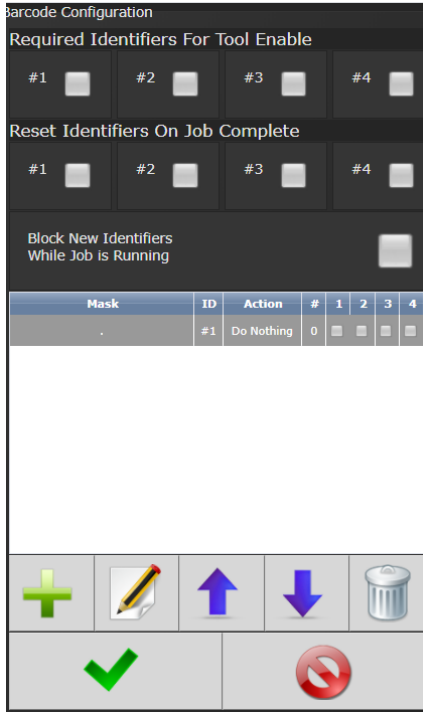

**Step 2:** Enter appropriate information on Barcode ID Configuration Screen.

**Identifier Mask:** The Mask is a string used to compare the received barcode against. The received barcode must be at least as long in length as the Mask. The Mask can also contain "don't care" characters of a decimal point or period in the string. These characters are counted in the length, however, the actual received character in that position doesn't matter.

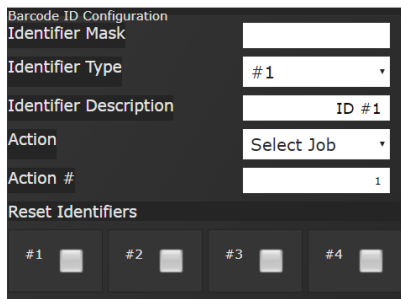

Example:



VIN#123456

**Identifier Type:** Identifies which identifier (ID#1-4) received barcode will be stored into.

**Identifier Description:** Text field can be used to give a description to each identifier type. (Example: Vehicle).

**Action:** Action executed by controller when barcode with a matching identifier mask is scanned. The actions are:

- Do Nothing
- Select Job (This will require a Job to be configured on the JOB page when using this option)
- Select PSet

**Action #:** When Select Job or Select PSet is selected, this is the number of the Job or PSet that will be selected.

**Reset Identifiers:** Can reset other identifiers (ID#1-4) when barcode is received. Click on identifiers to reset.

**Step 3:** Press  to save and re-enter completed barcode configuration screen.

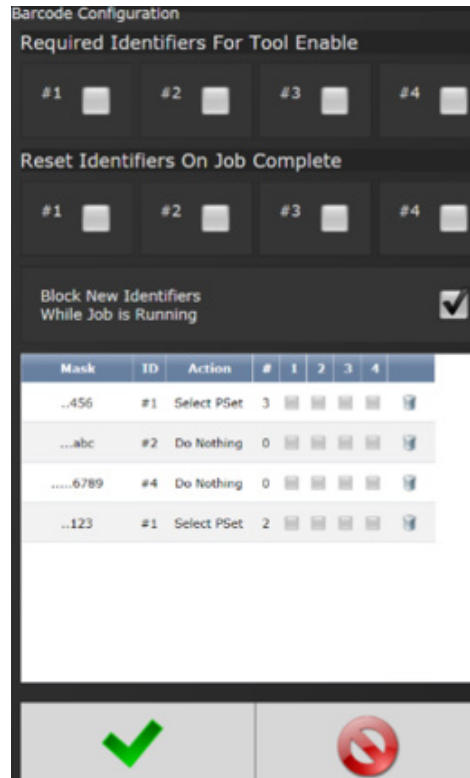

Click anywhere in body if additional identifiers are required.

Press  to save barcode configuration.

See "5. Barcode Reader Details" on page 58 for more information)

To configure Serial Port for Barcode Reader: On Home page click Controller → Communication Interfaces → Serial

Select Barcode Reader and the correct Baud rate.

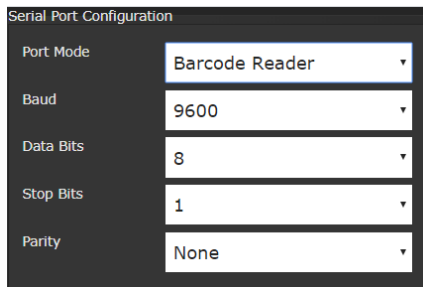

Press  to save changes.

## 4.5.8 Set Time

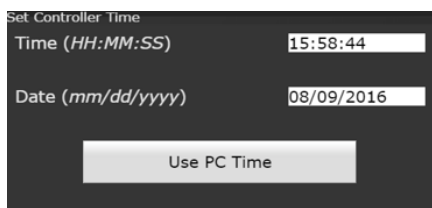

Set time and date. If connected to a PC, use PC Time to set controller time.

## 4.5.9 Remote Connections

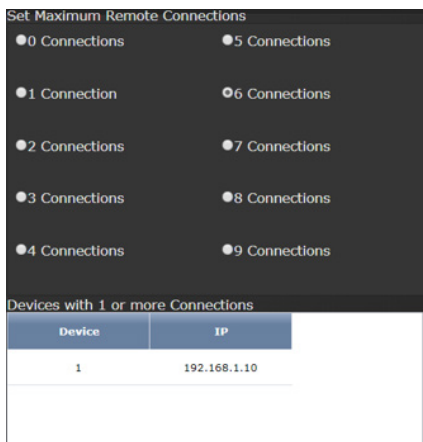

Sets number of remote browser connections to controller.

Displays the IP addresses of remote browser connections to the controller.

## 4.5.10 Master Spindle Setup

Several Gen IV controllers can be linked together via an Ethernet connection to create a multi-spindle network. Operations requiring multiple fasteners to be inserted simultaneously or in a synchronized fashion is possible with this setup. Up to 10 tools can be operated from one master controller. The spindle network can be controlled via physical IO or across supported protocols. PSets will be synchronized across the spindle network so PSets and Jobs will only need to be set up on the master controller. Spindle

rundown results are also viewable from the master.

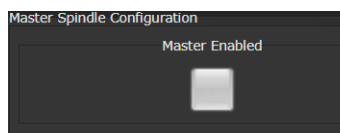

Click "Master Enable" to enter Master Spindle Configuration screen.

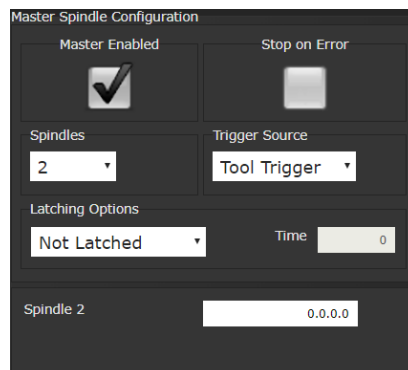

**Master Enabled:** Enable or disable the spindle network.

**Stop on Error:** All spindles will stop if any problem is reported (bad rundown, a stop condition, or a cable

disconnection has occurred on any spindle). If this option is not checked, spindles will finish the current rundown even if an error has occurred on one spindle.

**Spindles:** Use Dropdown to select number of Spindles to be connected in a Multispindle configuration

**Trigger Source:** Select whether the start input for running the spindle network comes from the master spindle's tool trigger, IO, or Remote Start.

\*All spindles need to have their start input set to respond to the master tool in order to have them all run from a single trigger or IO start signal. This is configured under Controller → Tool Setup → Start Input and set the input source to 'Start from Master Tool'.

**Latching Options:** Select latching throttle option. If Latch on Time is selected, the spindle network will continue to run after the throttle has been held down for the selected amount of time.

### 4.5.10.1 Setting up Multi-Spindle Network

See following page

## 4.5.11 Languages

Select from:

- English
- Chinese
- Japanese
- Korean
- Spanish
- Portuguese

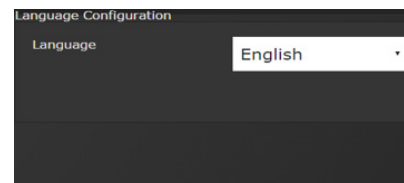

## 4.5.10.1 Setting up Multi-Spindle Network

### Hardware

Connect the master controller and spindles together via an Ethernet switch. Ensure that all controllers have the appropriate tools connected and apply power.

### Software

Steps to enable the multi-spindle network:

1. **Configure the IP address of each spindle:** Ensure that they are all on the same subnet.
2. **Set each controller to be controlled from the master controller:** Go to Controller → Tool Setup → Start Input and set the input source to 'Start from Master Tool'.
3. **Enable the master controller:** The configuration screen for setting up the master spindle controller is found under Controller → Master Spindle Setup. To begin setup, enable the master spindle by clicking on the red X under 'Master Enabled'. This will unroll several new options. Now set the number of spindles and add their IP addresses to the list. Click OK to add the spindles to the master controller. Clicking OK will synchronize PSets and time across the controllers.
4. **Add a PSet:** Once the PSet is saved then it is ready to be run.
5. **View the results:** Spindle network results can be found under the "Spindle Results" tab now appearing on the main menu. Clicking on a spindle result will show the results of each individual spindle.

**Spindle IP Addresses:** The number of spindles listed depends on the number of spindles enabled. Add the IP addresses of the spindles to add them to the spindle network.

### PSets: Synchronizing Stages

When setting up a PSet, the Sync stage is available to synchronize spindle rundowns. Sync stages allows each spindle to pause between stages and wait for other spindles to reach the same stage before proceeding.

For example, a PSet set up to perform TC, Sync, Unfasten, Sync, TC will ensure that all spindles reach the target torque before going to the unfasten stage. At that time, all spindles will unfasten to the desired angle and will not proceed until each spindle has completed that stage before running down to the final torque. The rundown curve for this type of PSet is shown with four spindles.

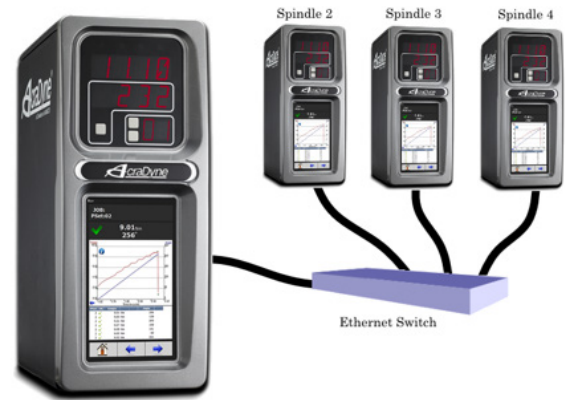

Master Controller (Spindle 1)

49 Total Master Spindle Rundowns				
ID	Time Stamp	Spindles	OK	ID Codes [1] [2]
49	04-27 15:45...	1,2,3,4	✗	
48	04-27 15:45...	1,2,3,4	✓	
47	04-27 15:44...	1,2,3,4	✓	
46	04-27 13:29...	1,2,3,4	✓	
45	04-24 18:13...	1,2,3,4	✓	
44	04-24 18:13...	1,2,3,4	✓	

Clicking on a spindle result item will display results of each spindle used in the operation

4 Spindle Rundowns					
Spin...	Ok	PSet	Torque	An...	
1	✓	1 [4Nm, Sync, Unfast...	8.18 Nm	✓	95°
2	✓	1 [4Nm, Sync, Unfast...	8.10 Nm	✓	114°
3	✓	1 [4Nm, Sync, Unfast...	8.12 Nm	✓	83°
4	✓	1 [4Nm, Sync, Unfast...	8.17 Nm	✓	58°

### PSet with Sync Example

PS 1 [4Nm, Sync, Unfasten, Sy...	
▶ 1 - TC [4, 100RPM]	
▶ 2 - Sync [5Sec]	
▶ 3 - Unfasten [180°, 200RPM]	
▶ 4 - Sync [5Sec]	
▶ 5 - TC [8, 100RPM]	
▶ Advanced	

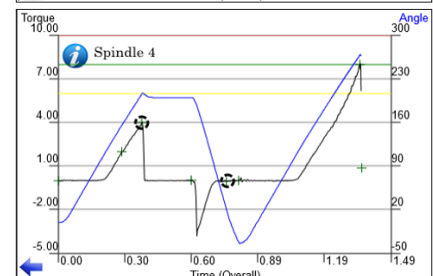
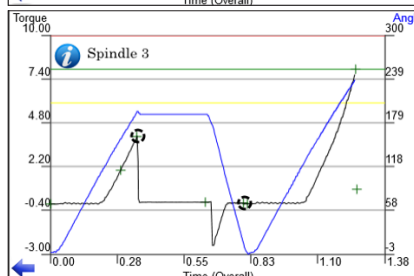
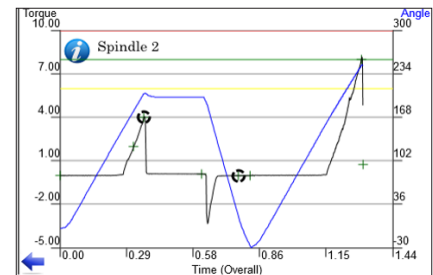
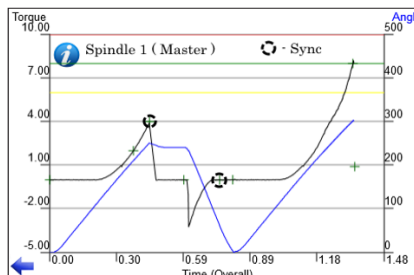

## 4.6 Tool

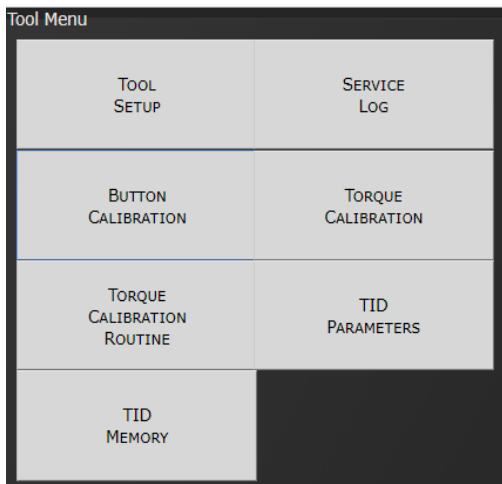

### 4.6.1 Tool Setup

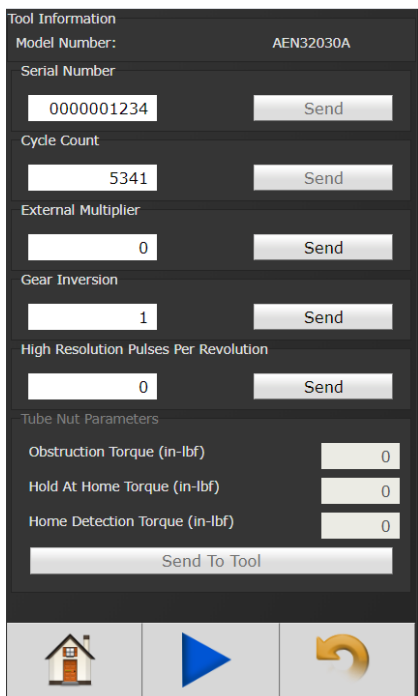

Allows user to make changes to Tool Setup.

**Model Number:** Tool model number of tool connected to controller.

**Serial Number:** Serial Number of current tool connected to controller.

**Cycle Count:** Total number of cycles since last reset.

**External Multiplier:** Configures tool to include gearing added to the base model. Units: Gear Ratio \* 100 (Example: Adding a multiplier with a gear ratio of 5:1, Multiplier setting = 5).

**Gear Inversion:** 1 = tool Output rotates same direction as motor  
-1 = tool Output rotates in opposite direction as motor.

**High Resolution Pulses Per Revolution:** Determines resolution of the tool motor hall sensors

**Tube Nut Parameters:** See "16. Tubenut Tool Setup Details" on page 82 for more information

**Obstruction Torque (in-lbf):** First 90° of rotation in the fastening direction. Cycle will be aborted if this torque is exceeded. If the tool rotates 90° and stops without any obstruction, the value is too low.

**Hold At Home Torque (in-lbf):** After reaching the open position, this is the torque preventing socket from bouncing to a partially closed position. This torque should be set to a value slightly less than the tubenut Home torque.

**Home Detection Torque (in-lbf):** In the reverse direction, reaching this torque indicates to controller that socket is in open position. If socket does not attempt to return to open position, this value is too low. AcraDyne recommends starting at approximately 12 in-lbs.

### 4.6.2 Service Log

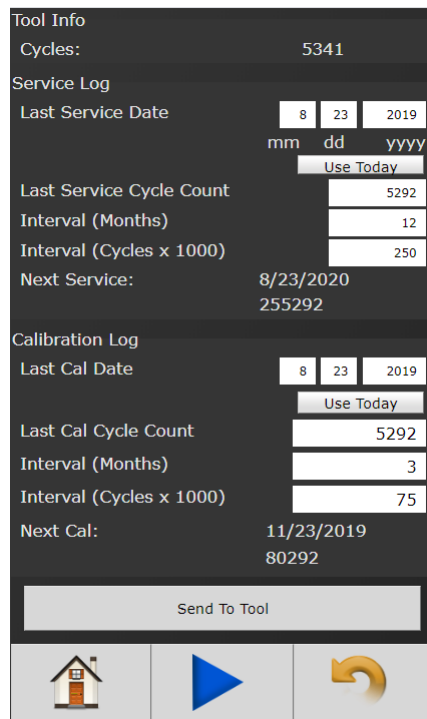

Service Parameters are stored in memory of tool and can be viewed in this screen. 'Next Service' or 'Next Cal' will turn red if value entered is exceeded.

### 4.6.3 Button Calibration

After a tool has been worked on, it is possible the relationship between hall sensors and magnet have changed. Using the 'Button Calibration' screen calibrates the field between the two.

Select "Button Calibration" from the Tool Menu.

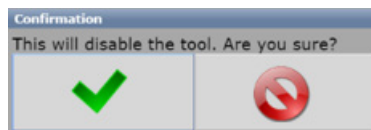

Tool disable confirmation screen will appear.



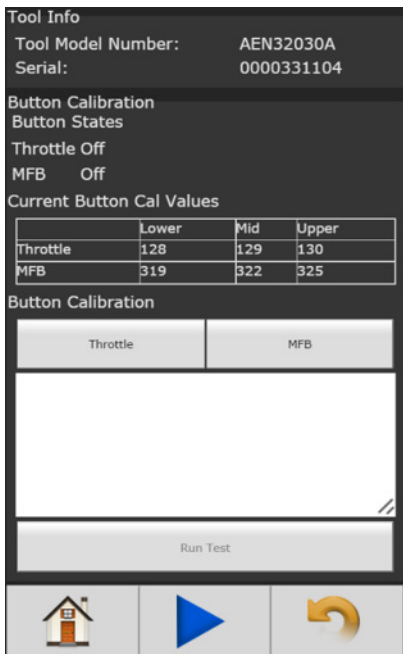

Test throttle and MFB (Multi-Function Button), send values to Tool ID board in this screen. Follow the on-screen instructions for button calibration.

## 4.6.4 Torque Calibration

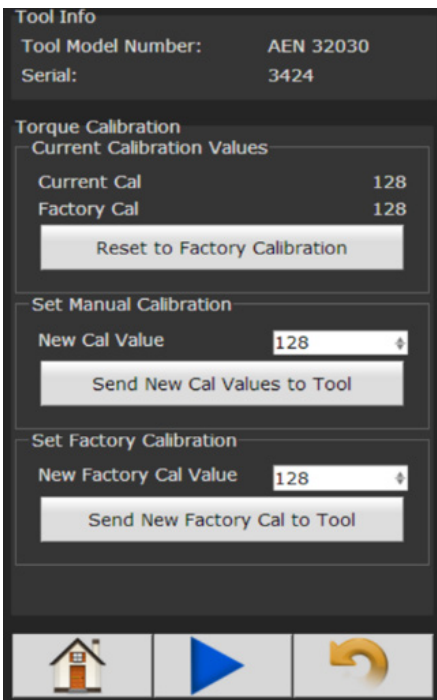

Manually calibrate and reset tool to Factory Calibration.

## 4.6.5 Torque Calibration Routine

Used to calibrate tool using a Master Transducer. The following are steps to calibrate tool.

1. Press the "Start Calibration" button.
2. Run Tool to Final Torque.
3. Enter external transducer (Master) value in Measured Torque box.
4. Press "Send New Cal Values to Tool" button.
5. 'New Cal' value is calculated automatically and assigned to tool ID Board.

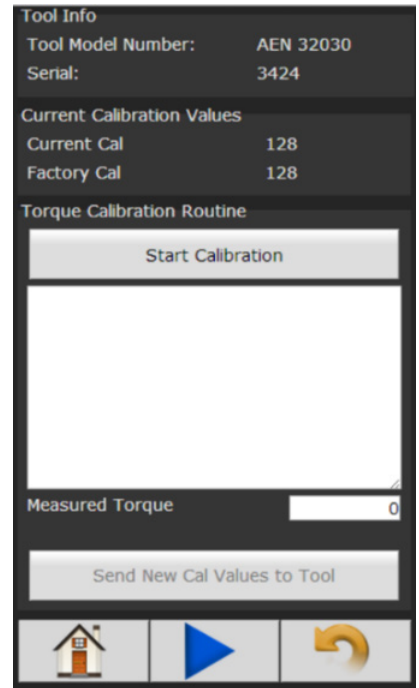

## 4.6.6 TID Parameters

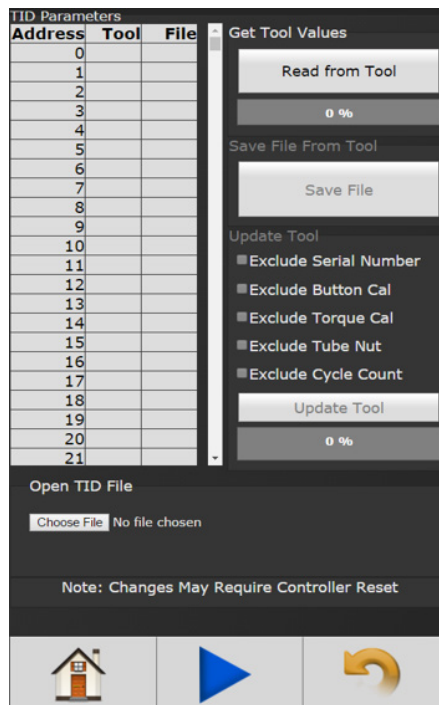

Used by factory to load Tool ID parameters into tool.

## 4.6.7 TID Memory

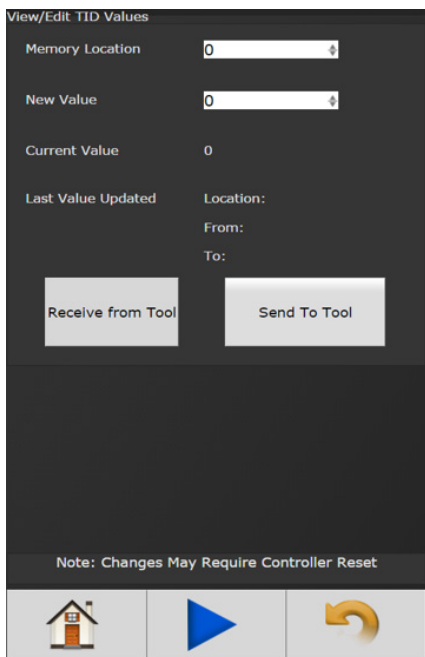

Allows a Qualified Service Technician to view or edit tool.

## 4.7 Accessories

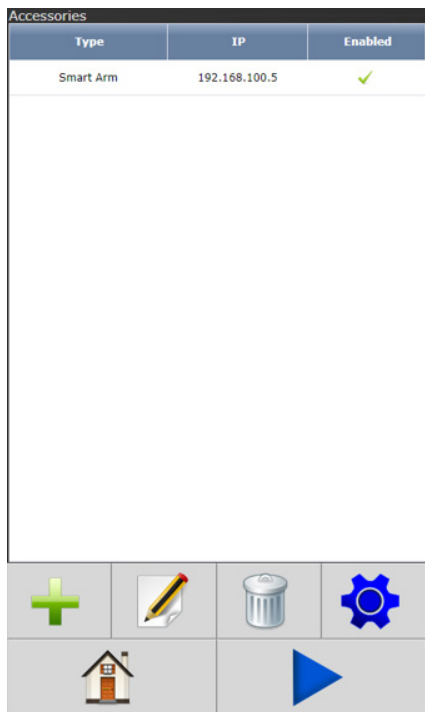

This screen shows accessories configured in the controller. New accessories can be added, edited, and deleted using the buttons at the bottom of the table. The gear icon navigates to the Accessory Scanning and Setup page.

The Smart Arm Accessory allows an articulated arm with encoders to be used with the Gen IV controller. Fastener locations

can be programmed into the controller so that the controller will perform specific actions when the tool is located on a specific fastener.

For more specific instruction contact: **AIMCO Technical Service, Toll Free 1-800-852-1368** or go to <http://www.aimco-global.com/manuals> and download the **Gen-IV Controller Smart Arm Configuration Manual**.

## 4.8 Diagnostics

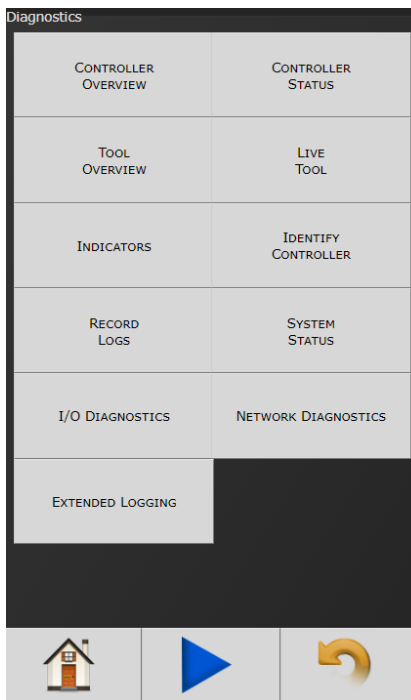

The Diagnostics menu contains all pertinent information regarding unusual behavior of the system. Detailed descriptions are given in the following sections.

### 4.8.1 Controller Overview

**Model Number:** Model Number of the controller.

**Serial Number:** Serial Number of the controller.

**Type:** Type of controller:

- **IEC:** Intelligent Electric Controller
- **IEC4W:** Intelligent Electric Controller 4 Mobile

**SYSREL:** System Release # shown

**Application:** Current Application software version.

**Firmware:** Current Firmware software version.

**Servo:** Current Servo Drive

**Available Hardware:** Available hardware on the controller.

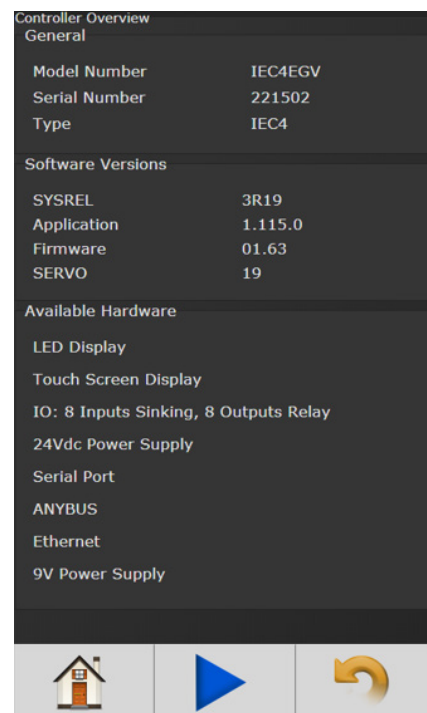

## 4.8.2 Controller Status

Controller Status	
<b>Bus Voltages</b>	
Servo Power	326
24 Vdc	OK
9 Vdc	8.93
5 Vdc	4.70
3.3 Vdc	3.21
SOM 1.8 Vdc	1.81
<b>Temperatures</b>	
CPU Temperature (° C)	34
Mainboard Temperature (° C)	32
<b>Active Faults</b>	

Shows "Live" status of controller, voltages, active faults, and temperature.

**Bus Voltages:** Alarm icon will appear on controller console and under "Active Faults" (see below) if any of these values are out of range:

- **Servo Power:** Live monitoring of power demand from tool to controller
- **24 Vdc:** Represents voltage from 24V power supply. Value is reported as on or off (.0-24.0 volts) and is for external use via 24V I/O port.
- **9 Vdc:** Represents voltage from 9V power supply powering Tool electronics.
- **5 Vdc:** Represents voltage from 5V power supply powering controller electronics.
- **3.3 Vdc:** Represents controller electronics internal 3.3V Bus voltage.
- **SOM 1.8 Vdc:** Represents controller electronics internal 1.8V Bus voltage

**CPU Temperature (° C):** Represents temperature of CPU measured in Celsius.

**Mainboard Temperature (° C):** Represents temperature inside controller measures in Celsius.

**Active Faults:** Any tool/ controller faults will be shown in this area.

## 4.8.3 Tool Overview

This "read only" screen gives an overview of the tool connected to the controller. The information is stored in the memory on the Tool ID board (TID).

- **Model Number:** Model number of tool connected to controller.
- **Serial Number:** Serial number of tool connected to controller.
- **Cycle Count:** Number of fastening cycles tool has performed since counter was reset.
- **Speed Range (RPM):** Free speed of tool output.
- **Maximum Torque (Nm):** Maximum torque output of tool.

The following information is used internally by AcraDyne Technicians and not generally relevant to the end user:

- **Gear Ratio After Transducer:** Any gearing between transducer and tool output.
- **Gear Inversion:** 1= Tool Output rotates same direction as motor. -1= Tool Output rotates in opposite direction as motor. (Example: Tube nut tools typically show -1 for gear inversion)
- **External Multiplier:** Gear ratio of external "after market" multiplier.
- **Pulses Per Revolution Output:** Number of motor hall pulses that occur per one revolution of motor Output.
- **Transducer Full Scale (Nm):** Full scale torque rating of transducer.
- **Discontinuous Mode Allowed:** Yes or No

Tool Overview	
<b>General</b>	
Model Number	AEN32030A
Serial Number	0000001234
Cycle Count	5505
<b>Capabilities</b>	
Speed Range (RPM)	47 - 950
Maximum Torque (Nm)	30.00
<b>Gear Information</b>	
Gear Ratio After Transducer	1.55
Gear Inversion	1
External Multiplier	0.00
Pulses Per Revolution Output	747
Transducer Full Scale (Nm)	20.00
<b>Discontinuous Information</b>	
Discontinuous Mode Allowed	No

## 4.8.4 Live Tool

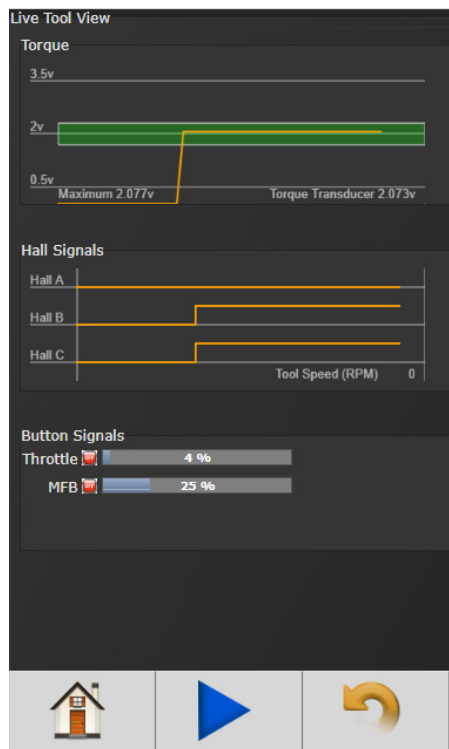

**Torque:** Shows a live view of tool transducer in volts. Voltage will be approximately 2.0 volts ( $\pm 0.005$  Vdc) when tool is at rest and torque is zero (verify the voltage is within the green zone in the graph).

During a rundown, tool transducer voltage increases as torque increases.

Motor Hall sensors A, B, C will be monitored along with tool throttle, Multi-Function Button, and RPM.

## 4.8.5 Indicators

Allows user to test tool LEDs, headlight, and buzzer.

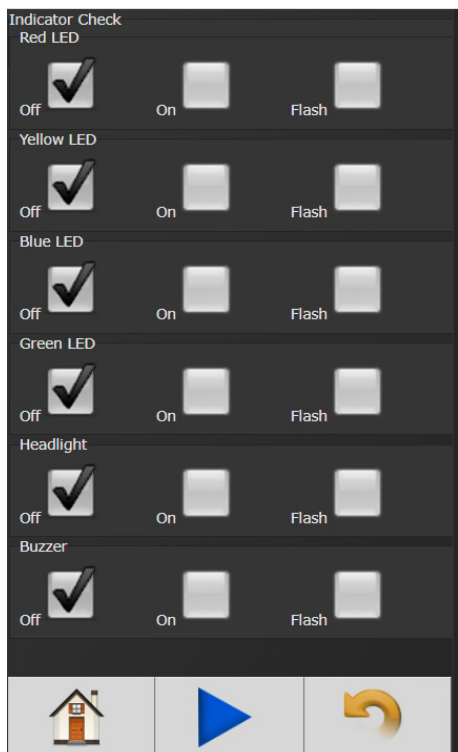

## 4.8.6 Identify Controller

'Identify Controller' will cause lights on controller and tool to flash making the system easy to locate. This is especially helpful when programming is being done and multiple controllers are being used in close proximity to each other.

## 4.8.7 Record Logs

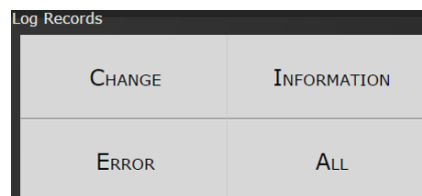

Logs information describing usage of controller and tools that have been used with that controller.

### 4.8.7.1 Change Log

Log displays changes made to tool or controller.

### 4.8.7.2 Information Log

Log displays all information entries.

### 4.8.7.3 Error Log

Log displays ONLY Error Entries.

### 4.8.7.4 All

Displays all Changes, Information and Error entries.

## 4.8.8 System Status

System Status		
Memory Usage		
Startup	Current	Increase
215712	246552	14.30%
Internal Storage		
KB Allocated	KB Available	KB Used
15620038	10934784	30%
USB Flash Drive		
KB Allocated	KB Available	KB Used
0	0	0

## 4.8.9 I/O Diagnostics

The I/O Diagnostics screen shows a log of all IO state changes from any assignable input or output. This can aid in verifying the correct functionality for IO configuration.

Assignable I/O Diagnostics			
I/O	Bus	Assignment	I/O State
Out	24v	Job Complete	0
Out	24v	Angle Low	0
Out	24v	Angle High	0
Out	24v	Torque Low	0
Out	24v	Torque High	0
Out	24v	NOK	0
Out	24v	OK	0

The refresh button will update the screen with the most recent IO changes.

The save button will generate a log file that can be viewed on a PC. This file can be downloaded when viewing from a PC or saved to a USB drive when using the controller touch screen. This saved CSV file contains much more detailed information (timing, IO settings, etc) than can be displayed on the controller screen.

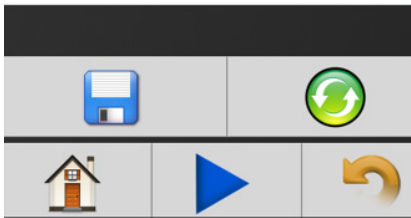

## 4.8.10 Network Diagnostics

Network Diagnostics can be useful in troubleshooting Ethernet communication issues

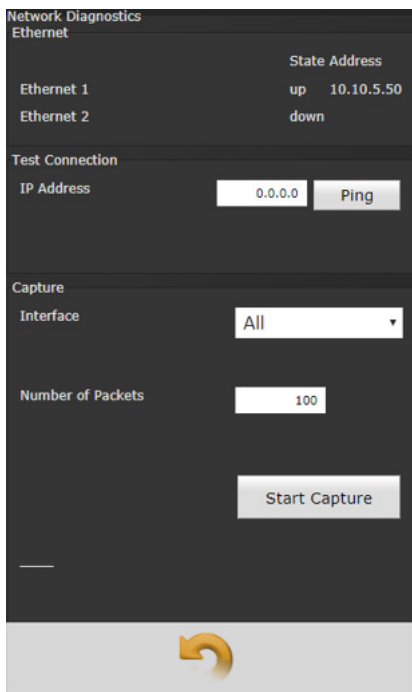

**Ethernet:** Shows if the Ethernet port is physically connected and if the hardware is operational.

**Test Connection:** Provides a way to check the ethernet connection to other devices on the same network.

**Capture:** Captures and saves the ethernet traffic for evaluation

## 4.8.11 Extended Logging

Extended Logging can provide more details to the rundown's curve data.

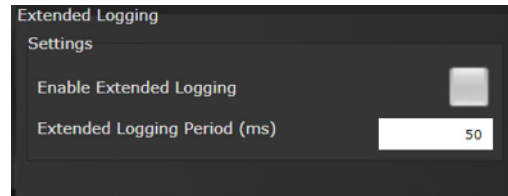

If Extended Logging is enabled, extra fastening events are logged in the curve data.

**NOTE:** Care should be taken when using this feature, as it will require more memory to store the curves and make the saved rundown records larger.

## 4.9 Login

When a password is required it can be entered in this screen.

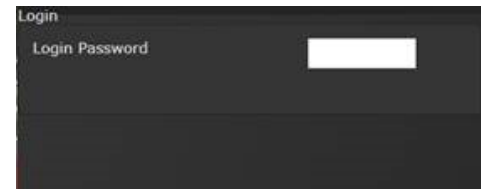

Three levels of access to the controller are available:

- **Operator:** Run/Login screens available.
- **Technician:** Run/PSet/Job/Diagnostics and Login screens available.
- **Administrator:** All screens available.

## 4.10 Advanced

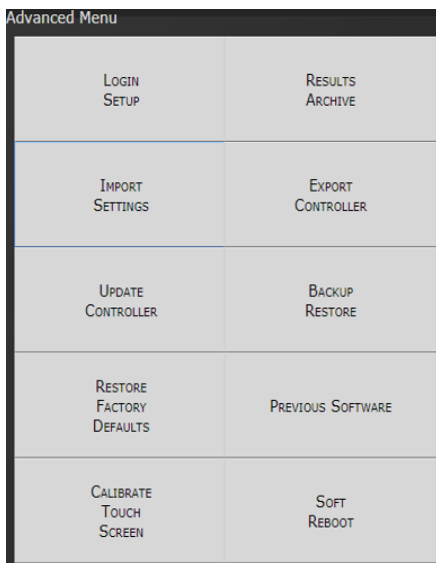

The 'Advanced' menu handles complex settings within the controller. Detailed descriptions are given in the following sections.

### 4.10.1 Login Setup

This screen allows the user to select the default Login level upon controller start up.

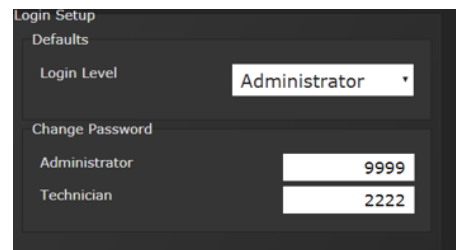

- Operator
- Technician
- Administrator

### 4.10.2 Results Archive

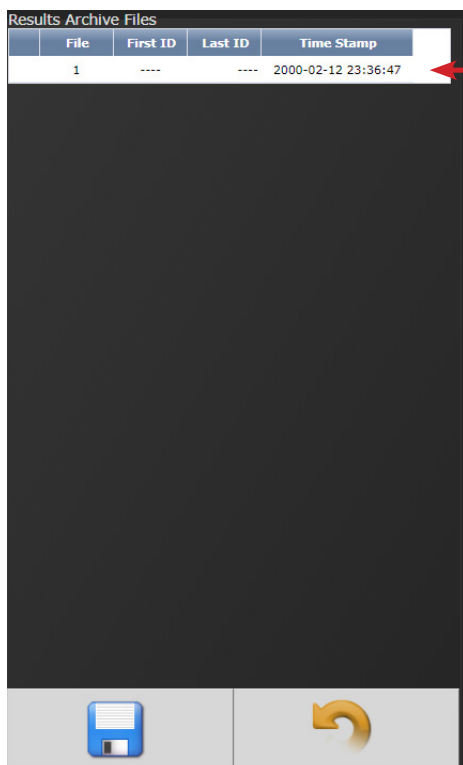

Select a file and press 

Approximately one million rundowns can be stored. Twenty files with approximately 50,000 rundowns are maintained at a time. The user can, at any time, save the runs to either a USB stick or to the Web as a CSV file imported directly into an Excel spreadsheet.

Using the touchscreen console, you can select multiple files to save.

Using the web option, you can select one of these files at a time to save (web option is default).

Select either USB or Web Archive location

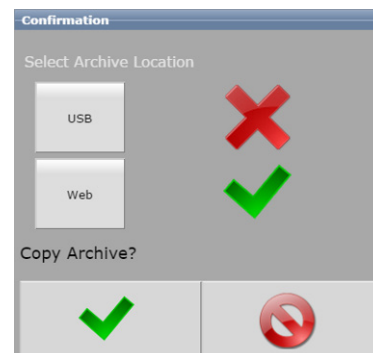

#### Example of Saved Excel File

Rundown	Job Num	Job Name	Sequence	Bolt count	Status	Date	Time	Torque	Status	Angle	Status	PSet Num	PSet Name	Tool Mod	Tool Serial	Id1 (ID #1)	Id2 (ID #2)	Id3 (ID #3)	Id4 (ID #4)
2068	0		0	0	P	#####	11:13:42	5.08	P	480	--	1			0				
2069	0		0	0	P	#####	11:13:49	5.054	P	535	--	1			0				
2070	0		0	0	P	#####	11:13:50	5.002	P	450	--	1			0				
2071	0		0	0	P	#####	11:13:52	5.013	P	595	--	1			0				
2072	0		0	0	P	#####	11:13:53	5.085	P	495	--	1			0				
2073	0		0	0	P	#####	11:13:54	5.1	P	440	--	1			0				
2074	0		0	0	P	#####	11:13:56	5.089	P	575	--	1			0				

## 4.10.3 Import Settings

This allows the user to download any previously saved settings onto the controller (refer to 'Export Controller' for help with saving data).

1. Plug the USB with an export file into any port on the controller.
2. From the Home screen, navigate to Advanced → Import Settings.
3. Select the settings to be checking the

corresponding box 

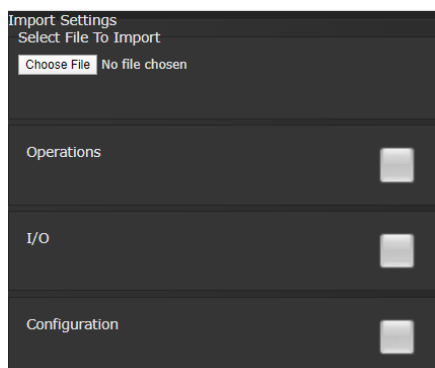



**Operations:** This includes PSets and Jobs.

**I/O:** This includes I/O settings for the local I/O, Anybus, Modbus, and EtherNet/IP.

**Configuration:** This includes all settings of the controller except I/O, Master Spindle, Rundowns, PSets or Jobs.

**Spindle:** This includes any Master Spindle setup (i.e. number of spindles, IP addresses, etc).

4. Press  to accept the changes.
5. Press  to proceed.
6. Press  when the import is complete and the controller will restart.

Import settings that were exported from another controller via a USB flash drive. Use this to quickly apply the same settings across several controllers. For example, it is common to have multiple controllers with the same I/O configuration. Set up one controller with the correct I/O configuration and export the controller from Advanced → Export Controller. Now the I/O settings can be imported using this screen.

**NOTE:** Setting can only be imported from controllers running the same version of software.

## 4.10.4 Export Controller

This allows the user to save Configuration, Operations, I/O, and Spindle settings onto a USB flash drive.

1. Plug a USB into any port on the controller.
2. From the Home screen, navigate to Advanced → Export Controller.
3. Press  to continue, and the controller will begin the export process.

4. Press  to complete the export.

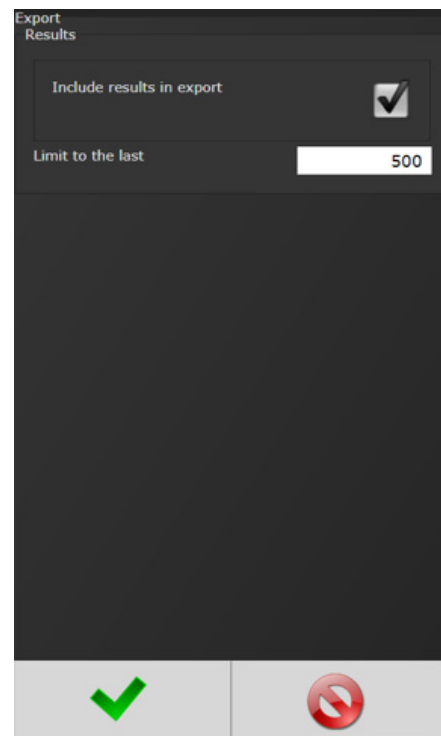

## 4.10.5 Update Controller

**NOTE:** Updated firmware versions will typically be sent via email zip file. Always save PSet and IP address information before upgrading controller.

### Upgrading the AIMCO Gen IV Controller

Using the TouchScreen or a System Port browser session, navigate to the 'Advanced' menu. Click 'Update Controller.'

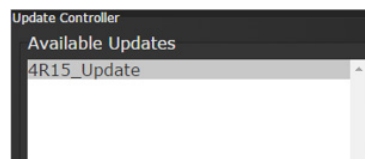

If a USB stick containing the zip file has been plugged in to the controller, the file will show in the

Available Updates list. Select the latest release and click  when ready.

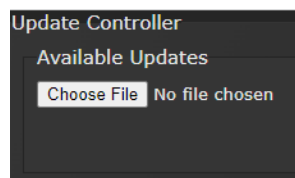

If updating through a system port browser session, a dialog box will appear. Click the Choose File button and navigate to the folder where the zip file is located on the computer. Select the latest release and click  when ready.

After the controller restarts, the user should see following messages

**Updating System**

**Do not unplug USB**

**Do not Power Off Controller**

**This may take a few minutes...**

*Controller Upgrade Notification*

When the controller has finished, navigate to Diagnostics → Controller Overview to view any changes to the 'Software Versions'. Any system settings (Ethernet IP address, PSets, Jobs, etc.) will remain unchanged.

## 4.10.6 Backup Restore

The Backup function allows the user to create an image of the controller software/firmware including all Configurations, Operations, I/O, and Spindle settings. This is used to create a point in which the controller can restore to if the need arises. In that case, the Restore function would be used.

1. From the Home screen, navigate to Advanced → Backup Restore.

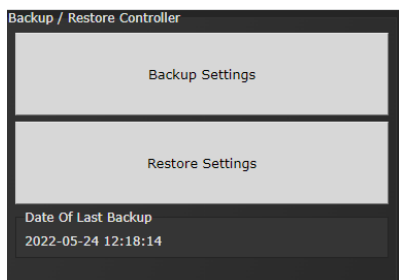

2. Press Backup to initialize the backup process.

3. Press  to replace previous backup with current system, the backup process will begin.

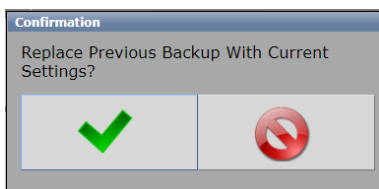

4. Press **Restore** to initialize the restore process.

5. Press  to restore all settings and firmware to last backup, the restore process will begin.

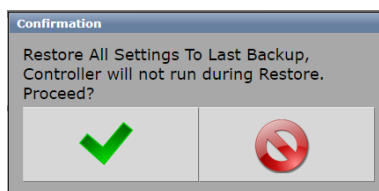

6. The controller will restart when finished.

## 4.10.7 Restore Factory Defaults

This allows the user to reset the controller's parameters to factory settings

1. From the Home screen, navigate to Advanced → Restore Factory Defaults.
2. Select the settings to be changed and accept 

- **Operations:** This includes PSets and Jobs.
- **I/O:** This includes I/O settings for the local I/O, Anybus, Modbus, and EtherNet/IP.
- **Configuration:** This includes all settings of the controller except I/O, Master Spindle, Rundowns, PSets or Jobs.
- **Results:** This includes all rundown data /information
- **Log:** This includes the Change, Information, Error, and Combined logs.

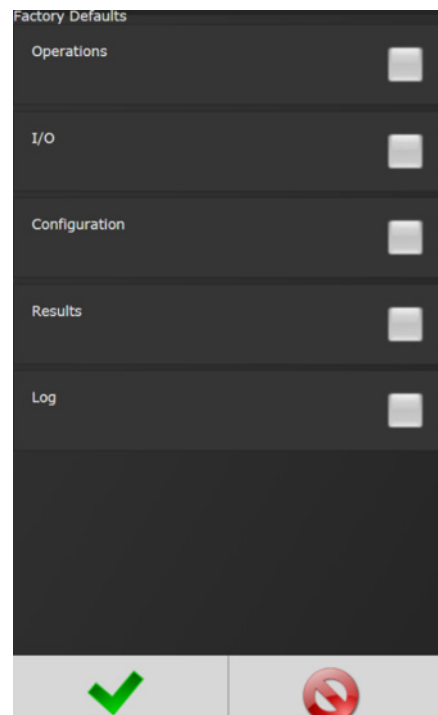

3. Press  to accept the changes.

4. Press  to proceed.

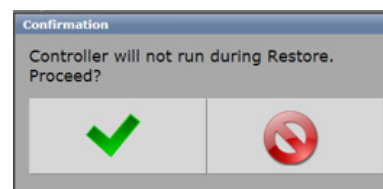

5. Press  when the calibration is complete, the controller will restart.

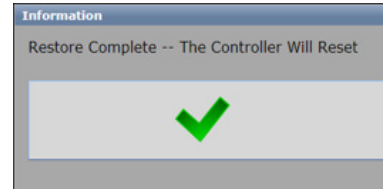



## 4.10.8 Previous Software

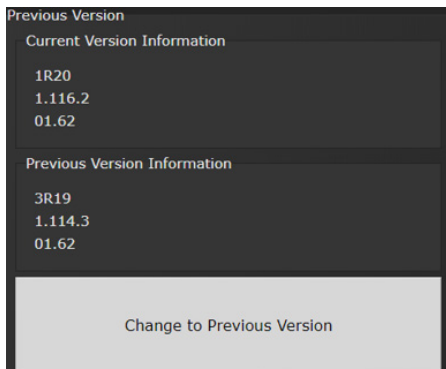

The 'Previous Software' page enables users to change the software to an alternate version. When the controller is updated, the previous version will be retained to easily revert

versions. Settings are not affected. Any changes to settings are retained when changing to an alternate version. The screen shows the current version along with the version information of the alternate version.

This feature is only available for versions 3R19 going forward. It is not possible to revert to a release earlier than 3R19.

## 4.10.9 Calibrate Touch Screen

Custom and Factory default calibration are available on the controller console.

1. From the Home screen, navigate to Advanced → Calibrate Touch Screen.
2. Press to disable the tool.
3. Select the desired calibration

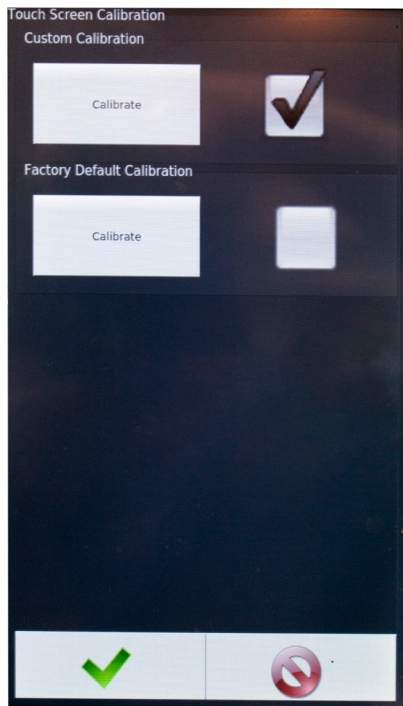

**Custom Calibration:** This allows the user to create a custom calibration setting for the touch screen.

**Factory Default Calibration:** This calibrates the touchscreen to the factory defaults.

4. Press to accept the selection.
5. Press to proceed.

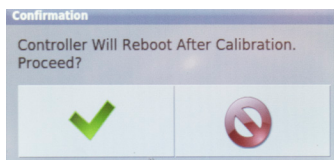

In the case of custom calibration, a screen will appear with instructions on how to increase precision.

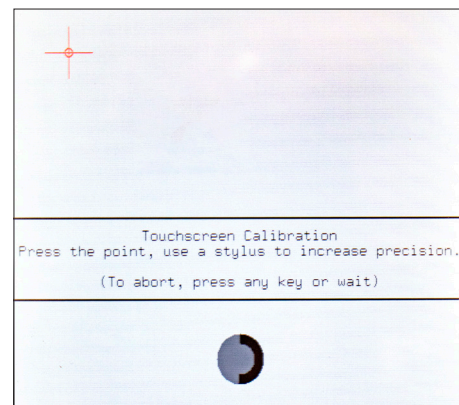

6. Press when the calibration is complete, the controller will restart.

**NOTE:** The controller may need to be reset before the custom calibration is possible.

## 4.10.10 Soft Reboot

Restart the controller without turning the power off.

1. From the Home screen, navigate to Advanced → Soft Reboot.
2. Press to proceed, the controller will restart.

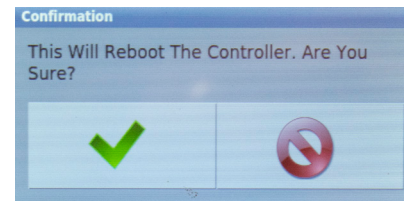

## 4.11 Statistics

Enter the desired number of samples and PSET to observe calculated statistics. Number of samples must be equal to or less than the existing recent results stored within the controller. Statistics are presented as a courtesy to users who wish to review them in quick fashion on the controller screen.

**Statistics, 13 Samples**

	Torque	Angle
Min	11.602 Nm	191 °
Max	11.865 Nm	208 °
Range	0.263 Nm	17 °
Low	0.0 %	--
Ok	0.0 %	--
High	100.0 %	--
$\bar{x}$	11.699 Nm	198.3 °
$\sigma$	0.084 Nm	5.8 °
$\bar{x} - 3\sigma$	11.446 Nm	181.1 °
$\bar{x} + 3\sigma$	11.951 Nm	215.6 °
$6\sigma$	0.505 Nm	34.5 °
$6\sigma / \bar{x}$	0.043	0.2
Cp	3.672	--
Cpk	-5.899	--

Sample Size:

Pset:

At the bottom of the screen are three buttons: a green checkmark, a green circular arrow, and a yellow curved arrow.

## 5. Barcode Reader Details

The Gen IV controller supports the following barcode reader functionality:

- Support up to four identifiers.
- Each rundown result can be associated with up to four identifiers.
- Identifier(s) can be used to select a parameter set or a job.
- Display identifier(s) on controller.
- Ability to lock-out tool until correct identifier(s) is entered.
- Ability to block barcode reads while a job is in progress.
- Barcode reads (identifiers) can come from any or all the following sources:
  - Serial barcode reader
  - Open protocol
  - Fieldbus network
  - Telnet port

### Solution

Regardless of the source (serial barcode reader, telnet, fieldbus, or protocol) each new string is passed through the same process:

- All four identifiers are reset to an empty string on power-up.
- Each received barcode is processed through a Barcode Match Table to look for a match, if one is found the barcode is accepted.
- Each fastening will then be associated with the received barcode(s) until a new one is received or they are reset.

### Parameters

The parameters that pertain to the processing of barcode strings:

- The Barcode Match Table is used to identify the newly received barcode string.
- Which of the four Identifiers (ID#1-4) are required to enable the tool?
- Which of the four Identifiers (ID#1-4) to reset on a job complete?
- Parameter to disable all barcode reads while a job is in progress. If set, barcode reads will be disabled after the first fastener is ran until job is complete.

### Barcode Match Table

The Barcode Match Table is used to identify which barcode has been received. The controller can have up to 99 entries (rows) in the table. Each entry has actions that will be performed when a matching barcode is received. The table is searched from

top to bottom in an attempt to find a matching barcode. If none are found, the barcode is ignored.

### Mask

The Mask is a string used to compare against the received barcode. The received barcode must be at least as long in length as the Mask. The Mask can also contain "don't care" characters of a decimal point or period in the string. These "don't care" characters are counted in the length but the actual received character in that position doesn't matter.

### Identifier Type

The "Identifier Type" field identifies which identifier (ID#1-4) the received barcode will be stored in.

### Action

Action can be one of the following:

- None
- Select PS#1-256
- Select Job#1-20

### Reset ID

The "Reset ID" has the ability to reset other identifiers (ID#1-4) when barcode is received.

### Examples:

#### Operator Scans

When a vehicle enters the station, the operator scans the VIN. The controller selects the correct job number and enables the tool. Each fastener will be identified with this VIN stored locally, and/or sent to a server for storage. The job settings will disable the tool when the job is complete.

#### Setup

In this example, there are three possible vehicle types each with its own job. The barcode scan will select the correct job (enabling the tool) and the scan will be stored into ID#1.

Mask	ID type	Action	Reset ID				
			ID#1	ID#2	ID#3	ID#4	
"VIN.....7..."	ID#1	Select Job#	1	No	No	No	No
"VIN.....8..."	ID#2	Select Job#	2	No	No	No	No
"VIN.....9..."	ID#3	Select Job#	3	No	No	No	No

The tool enable/disable will be controlled by the job settings; the correct job will be selected by the barcode scan. The "ID Required to Enable the Tool" feature does not need to be utilized.

Required Identifiers for Tool Enable			
ID#1	ID#2	ID#3	ID#4
No	No	No	No

These settings are irrelevant since the only way to enable the tool is with a new job and the only way to select a new job is to scan a new barcode.

Reset Identifiers on Job Complete			
ID#1	ID#2	ID#3	ID#4
Yes	No	No	No

### Examples

This is what the 'Operator Scans' example looks like once set up in the Barcode Configuration Screen (see "4.5.7 Bar Code Setup" on page 45).

### Airbag Install

The customer wants to track the serial number of each airbag being installed, as well as the operator installing it. When the operator reports to the station, they will scan their employee ID. When the vehicle comes into the station, the operator scans the VIN of the vehicle and the serial number of the airbag. Once all three scans are received, the tool is enabled. Once the correct number of fasteners are installed, the tool is disabled by the job settings. From that point, the operator only needs to scan the vehicle and the airbag to enable the tool.

### Setup

We will assign the employee ID to ID#1, the vehicle VIN to ID#2, and the airbag serial number to ID#3. Scanning a new employee ID will reset the other IDs and force a scan of the vehicle VIN and airbag serial number. The scan of the vehicle VIN will also select the correct job number.

Mask	ID type	Action	Reset ID			
			ID#1	ID#2	ID#3	ID#4
"EMP...."	ID#1	None	No	Yes	Yes	No
"VIN....."	ID#2	Select Job#	1	No	No	No
"SN....."	ID#3	None	No	No	No	No

Once all three scans are received, the tool will be enabled.

Required Identifiers for Tool Enable			
ID#1	ID#2	ID#3	ID#4
Yes	Yes	Yes	No

When job is complete, the vehicle VIN will be reset and the airbag serial number, but not the employee ID; this way subsequent vehicles will only require a VIN and S/N to enable tool.

Reset Identifiers on Job Complete			
ID#1	ID#2	ID#3	ID#4
No	Yes	Yes	No



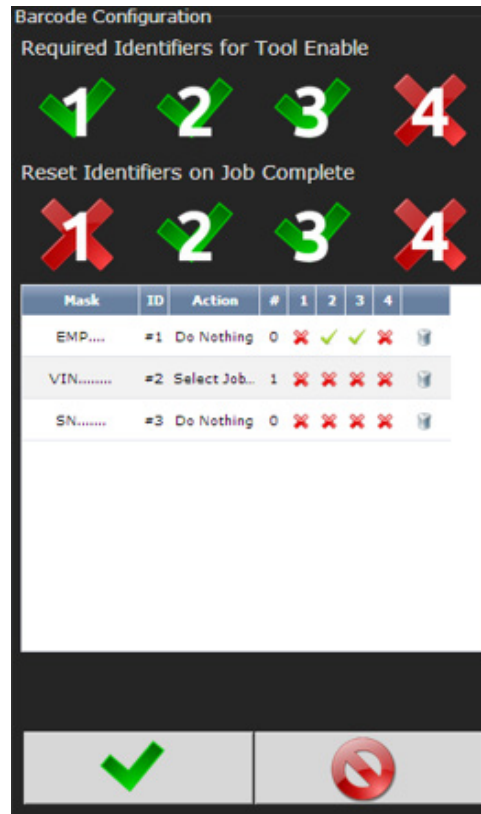













This is what the Airbag Install example looks like set up in "4.5.7 Bar Code Setup" on page 45.







## 6. Glossary of Terms

<b>Acceleration</b>	<p>This setting controls how quickly the tool comes to programmed RPM. The value is stated in thousand(k) revolutions per minute (RPM) per second(s).</p> <p>Default setting is 10 which means that at the start of the rundown or stage, the tool will reach 10,000 RPMs in a one second period of time.</p> <p>Given the speed ratings of the tools in the AcraDyne range, this means that the programmed RPM will instantly be running at the throttle press, or start, of the stage.</p> <p>To increase the time in which the tool comes up to speed (aka Soft Starting) the value should be reduced to the level desired.</p> <p>Controller Firmware will limit the programmed value to effect the tool down to 10% of its rated speed. This means that a 1,000 RPM tool can be set to accelerate at 100 RPM/Second. Should an entry be made that is lower than this value, the Firmware of the controller will run the step/stage at no less than 100 RPM/Second</p> <p><u>For a theoretical example:</u>                  A setting of 1 will result in the tool accelerating (reaching the programmed RPM setting) in a 1,000 RPM step over a time period of 1 second. If the programmed speed was 2,000 RPM it would take 2 seconds to reach that 2,000 RPM setting during that step or stage of the rundown.</p> <p>A setting of .5 will result in the tool accelerating (reaching the programmed RPM setting) in a 500 RPM step over a time period of 1 second. Using the 2,000 RPM example, it would take the tool 4 seconds to reach 2,000 RPM.</p> <p><b>Summary: Lower values equal slower ramp up to programmed speed.</b></p>	<b>Job</b>	<p>A Job is a collection of Psets or Multi-stages, which are useful when performing several multiple fastening operations, each with different requirements. This is convenient since the operator does not have to select a new Pset or Multistage for every fastening.</p>
<b>Accept Tone</b>	<p>Controls tone made from handle of handheld tools for accepted fastening cycles.</p>	<b>Low Angle</b>	<p>When the peak angle recorded during the Angle Audit Step fails to reach the Low Angle, fastening cycle is recorded as a reject for Low Angle, the low angle light (flashing yellow) illuminates, and fastening cycle is given an overall status of NOK.</p>
<b>Angle</b>	<p>Degree fastener rotates from snug, or threshold level, to peak torque.</p>	<b>Low Torque</b>	<p>When the peak torque recorded fails to reach the Low Torque, fastening cycle is recorded as a reject for Low Torque, the Low Torque light (flashing red) illuminates, and fastening cycle is given an overall status of NOK.</p>
<b>Cycle Complete</b>	<p>Torque level that determines completion of a fastening cycle.</p>	<b>MFB</b>	<p>Multi-Function Button</p>
<b>High Angle</b>	<p>When peak angle recorded exceeds High Angle, the fastening cycle is recorded as a reject for High Angle, the High Angle light (flashing yellow) illuminates, and fastening cycle is given an overall status of NOK.</p>	<b>Multi-stage</b>	<p>In some instances, it is necessary to perform a fastening in several stages. This requires specific fastening strategies. Multi-stage allows user to create linear sequences up to 256 Psets to perform a fastening divided into stages.</p>
<b>High Torque</b>	<p>When peak torque recorded exceeds the High Torque, the fastening cycle is recorded as a reject for High Torque, the High Torque light (flashing red) illuminates, and fastening cycle is given an overall status of NOK.</p>	<b>Parameter Set</b>	<p>A Parameter Set is a collection of instructions that define how the tool should perform the fastening process. It may be selected from the console or device such as a socket tray or PC.</p>
		<b>Snug Torque</b>	<p>Controller begins to monitor tool for angle at a preselected threshold torque. Any increase in angle, after the snug point, results in a corresponding increase in tension or clamp load within the joint.</p>
		<b>Speed</b>	<p>Speed at which tool operates during the initial portion of the fastening cycle prior to downshift.</p>
		<b>Spindle</b>	<p>A spindle represents a connection to a handheld, or fixtured, tool connected to a controller.</p>
		<b>Strategy</b>	<p>Identifies the variables being used to control tool during a fastening cycle.</p>
		<b>Thread Direction</b>	<p>Sets assembly direction to clockwise (CW) or counter clockwise (CCW).</p>
		<b>Threshold Torque</b>	<p>Sets point at which tool is "In Cycle".</p>
		<b>Torque Calibration</b>	<p>Determines how torque values are assigned to the electrical signals for torque transducer on tool. Value is unique to each tool and changes over time.</p>
		<b>Torque Target</b>	<p>When the tool is being controlled for torque, the torque target instructs controller when to shutoff tool. Torque target should be greater than Low Torque and less than High Torque, this is required for torque control.</p>











7. Icons Defined

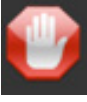
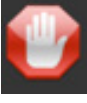





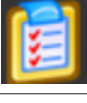
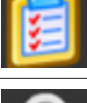



Icon	Description	Function	Where Used
	Home Navigation Button	Navigate to the main menu ("HOME") screen.	All screens except for edit screens.
	Run Navigation Button	Navigate to the Run Screen.	All screens except for edit screens.
	Run Screen Select Buttons	Switch between the different run screen pages.	Run Screen
	Go Back Button	Navigate to one menu level back.	All screens except for edit screens.
	Accept Changes Button	Accept the changes made and return to the parent screen.	Edit screens
	Cancel Changes Button	Reject the changes made and return to the parent screen.	Edit screens
	Add New Button	Add a new item (Pset, Stage, Job, and other).	PSet and Job edit screens.
	Edit Button	Edit selected Item.	PSet and Job edit screens.
	Move Up and Down Buttons	Move selected item up or down in the sequence order.	PSet and Job edit screens.
	Copy Button	Copy selected Items	PSet, Job, and other edit screens.
	Delete Button	Remove or un-assign selected items.	Edit and list view screens.
	Filter Button	Filter Items in a list or table.	List view screens
	Save Button	Save selected item to file.	List view screens
	Select Columns Button	Allows customization of columns shown on the Results Screen.	Results Screen
	Fault Indicator	Fault exists that is preventing the tool from running (can be pressed for more Info).	Run Screen
	Invalid PSet Indicator	Selected Pset does not exist or is not valid.	Run Screen

Icon	Description	Function	Where Used
	Barcode Scan Required Indicator	A barcode is required to enable the tool.	Run Screen
	Job Complete Indicator	Job is complete.	Run Screen
	Lock on Reject (LOR)	Lock tool on rejected fastener.	Run Screen
	Disassembly	A disassembly event has been detected.	Run Screen
	Job Reset Complete	Reset Job has finished. Results from last successful rundown of a job are cleared.	Add New Job Screen

## 8. Stop Codes

If a Stop condition is detected that prevents the tool from running, a code will appear on the LED display. Any active stop conditions are also displayed on the RUN screen.

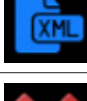
Code	Icon	Description
<b>IO</b>		Stopped or Disabled from Physical 24 volt IO input
<b>ABUS</b>		Stopped or Disabled from ANYBUS
<b>MODB</b>		Stopped or Disabled from Modbus
<b>EIP</b>		Stopped or Disabled from Ethernet IP
<b>RTU</b>		Stopped or Disabled from Modbus RTU
<b>OP</b>		Stopped or Disabled from Open Protocol
<b>OP</b>		Lost Open Protocol Connection
<b>REV</b>		Disassembly Disabled
<b>ARM</b>		Tool Requires Arming – MFB button configured to enable the tool to run.
<b>JOB</b>		Job Sequence Complete
<b>JOB</b>		Job Complete
<b>JOB</b>		XML Count Complete
<b>LOR</b>		Locked on Reject

Code	Icon	Description
<b>BRCD</b>		Bar Code ID scan required to enable tool
<b>SRVC</b>		Tool Disabled For Service - Tool service or calibration interval has expired
<b>INVP</b>		Invalid PSet - Parameter set number for a non-existent Pset has been selected to run. Most likely via one of the following methods: <ul style="list-style-type: none"> <li>○ Job</li> <li>○ MFB</li> <li>○ I/O</li> </ul>
<b>INVP</b>		PSet outside of Job - Parameter set number outside of the job has been selected. Most likely via one of the following methods: <ul style="list-style-type: none"> <li>○ MFB</li> <li>○ I/O</li> </ul>
<b>INVJ</b>		Invalid Job - Job number for a non-existent Job has been selected to run. Most likely via one of the following methods: <ul style="list-style-type: none"> <li>○ MFB</li> <li>○ I/O</li> </ul>
<b>PSET</b>		PSet Mismatch
<b>SPND</b>		Spindle Not Configured – Spindle selected to run from a Multi-Spindle Job has not been configured
<b>NET</b>		XML Disconnected
<b>XML</b>		Stop from XML
<b>NOK</b>		XML Max Rejects Exceeded
<b>FLT</b>		Controller Fault - Error has been detected. See fault code list for details

## 9. Error Codes

If an error condition is detected that prevents the tool from running, a fault code will appear on the LED display. Any active faults are also displayed on GUI RUN screen. Fault history can be viewed in the Controller Error Log.

### Gen4 Common Hardware Fault Codes

Code	Fault Type	Description	Possible Causes
<b>FH17</b>	1.8vdc MB out of tolerance	Main board 1.8 bus voltage exceeds electrical limits	<ul style="list-style-type: none"> <li>Faulty Controller main board or other Controller electronics</li> </ul>
<b>FH18</b>	1.8vdc SOM out of tolerance	System on Module 1.8 bus voltage exceeds electrical limits	<ul style="list-style-type: none"> <li>Faulty Controller main board or other Controller electronics</li> </ul>
<b>FH19</b>	3.3vdc out of tolerance	Main board 3.3 bus voltage exceeds electrical limits	<ul style="list-style-type: none"> <li>Faulty Controller main board or other Controller electronics</li> </ul>
<b>FH20</b>	5vdc out of tolerance	5 Volt bus voltage out of range	<ul style="list-style-type: none"> <li>Faulty power supply or wiring</li> <li>Faulty Controller main board or other Controller electronics</li> </ul>
<b>FH21</b>	9vdc out of tolerance	9 Volt bus voltage out of range	<ul style="list-style-type: none"> <li>Faulty power supply or wiring</li> <li>Faulty Controller main board or other Controller electronics</li> <li>Faulty tool cable</li> <li>Faulty tool electronics or wiring</li> </ul>
<b>FH22</b>	24 volt level low	24 Volt I/O power not detected	<ul style="list-style-type: none"> <li>Faulty power supply or wiring</li> <li>Short or other problem with external connections to the 24Volt I/O port.</li> </ul>
<b>FH23</b>	Controller temp high	Controller's internal temperature exceeds limit	<ul style="list-style-type: none"> <li>Ambient air temperature exceeds rating of Controller</li> </ul>
<b>FH24</b>	+15vdc out of tolerance	+15 Volt bus voltage out of range	<ul style="list-style-type: none"> <li>Faulty power supply or wiring</li> <li>Faulty Controller main board or other Controller electronics</li> <li>Faulty tool cable</li> <li>Faulty tool electronics or wiring</li> </ul>
<b>FH25</b>	-15vdc out of tolerance	-15 Volt bus voltage out of range	<ul style="list-style-type: none"> <li>Faulty power supply or wiring</li> <li>Faulty Controller main board or other Controller electronics</li> <li>Faulty tool cable</li> <li>Faulty tool electronics or wiring</li> </ul>
<b>FH32</b>	Processor Fault	RTOS processor not communicating with the Application processor	<ul style="list-style-type: none"> <li>Faulty mainboard electronics</li> <li>RTOS processor firmware corrupted or not loaded</li> <li>Faulty SOM board or connector</li> </ul>

## IEC (AcraDyne DC Tool) Specific Fault Codes

CODE	Fault Type	Description	Possible Causes
<b>FT01</b>	Tool not connected	Tool communication timeout	<ul style="list-style-type: none"> <li>• Tool not connected</li> <li>• Faulty tool cable</li> <li>• Faulty tool electronics or wiring</li> </ul>
<b>FT02</b>	Invalid TID parameters	Tool parameter file not compatible with Controller	<ul style="list-style-type: none"> <li>• Corrupt tool ID memory location</li> <li>• TID file not loaded in tool</li> </ul>
<b>FT04</b>	Torque signal out of Range	Tool torque signal voltage is beyond electrical limits	<ul style="list-style-type: none"> <li>• Tool not connected</li> <li>• Faulty tool cable</li> <li>• Faulty transducer</li> <li>• Transducer electronics not calibrated</li> <li>• Faulty tool/controller electronics or wiring</li> </ul>
<b>FT05</b>	Torque tare value out of range	Tool torque signal no load voltage is out of range	<ul style="list-style-type: none"> <li>• Transducer electronics significantly out of calibration</li> <li>• Faulty transducer</li> <li>• Faulty tool cable</li> <li>• Tool gear binding</li> <li>• Faulty controller electronics or wiring</li> </ul>
<b>FT06</b>	Motor hall states invalid	Hall signals states are all high or all low	<ul style="list-style-type: none"> <li>• Tool not connected</li> <li>• Faulty tool cable</li> <li>• Faulty tool electronics or wiring</li> <li>• Faulty motor halls or wiring</li> </ul>
<b>FT07</b>	Motor halls skipping states	Hall signal sequence incorrect	<ul style="list-style-type: none"> <li>• Faulty tool cable</li> <li>• Faulty tool electronics or wiring</li> <li>• Faulty motor hall or wiring</li> <li>• Hall signal leads are connected incorrectly</li> <li>• Too many tool extension cables</li> </ul>
<b>FT08</b>	Tool ground not connected	Tool ground conductors not connected	<ul style="list-style-type: none"> <li>• Tool not connected</li> <li>• Faulty tool cable</li> <li>• Faulty tool ground wires</li> <li>• Faulty tool electronics or wiring</li> </ul>
<b>FD12</b>	Drive not connected	Drive CAN communication time out	<ul style="list-style-type: none"> <li>• Faulty Controller main board electronics</li> <li>• Faulty drive electronics or connection</li> </ul>
<b>FD13</b>	Drive Fault SW	Drive reporting fault via CAN communication	<ul style="list-style-type: none"> <li>• Tool not connected</li> <li>• Faulty tool cable</li> <li>• Faulty tool motor</li> <li>• Application exceeds capability of drive</li> <li>• Faulty drive</li> </ul>
<b>FD14</b>	Drive Fault HW	Drive reporting fault via IO signal	<ul style="list-style-type: none"> <li>• Tool not connected</li> <li>• Faulty tool cable</li> <li>• Faulty tool motor</li> <li>• Application exceeds capability of drive</li> <li>• Faulty drive</li> </ul>
<b>FD15</b>	Drive Vbus high	Drives DC bus voltage exceeds electrical limits	<ul style="list-style-type: none"> <li>• AC supply power exceeds voltage ratings of Controller</li> </ul>
<b>FD16</b>	Drive Vbus low	Drives DC bus voltage is too low to run tool	<ul style="list-style-type: none"> <li>• Supply power cycled too quickly. Five second delay required after switching off the Controller before turning back on.</li> </ul>
<b>FS26</b>	Power on throttle	Run command on power up	<ul style="list-style-type: none"> <li>• Tool laying on lever on power up</li> <li>• Tool buttons out of calibration</li> <li>• Run command from logic I/O on power up.</li> </ul>
<b>FS27</b>	Locked rotor	Motor has stalled for more than 100 milliseconds	<ul style="list-style-type: none"> <li>• Poor parameter settings for application.</li> <li>• Torque signal out of calibration</li> <li>• Faulty tool gearing or motor</li> <li>• Corrupted TID parameters</li> <li>• Faulty Controller or tool electronics</li> </ul>
<b>FS28</b>	Target out of range of tool	Parameter set torque target out of range of rated tool capability	<ul style="list-style-type: none"> <li>• Target torque exceeds tool capability</li> <li>• Joint Compensation Ratio set too low.</li> <li>• Corrupted TID parameters</li> </ul>
<b>FS29</b>	Invalid tool	Tool configuration not compatible with parameter set	<ul style="list-style-type: none"> <li>• Tubenut tool commanded to run a parameter set with left hand thread direction or with an unfastening stage</li> <li>• Tubenut tool commanded to go in the disassembly direction</li> </ul>
<b>FS31</b>	Lost Master Start Signal	Lost Connection to Master Spindle	<ul style="list-style-type: none"> <li>• Faulty Ethernet Connection</li> <li>• RTOS processor firmware corrupted or not loaded</li> <li>• Faulty SOM board or connector</li> </ul>



## 10. Dual-Lever Tools Requiring Two-Handed Operation

### Two Handed Functionality

- Tool will not run unless both switches are pressed within one second of each other.
- If the one second timer times out, both switches must be released to reset the timer.
- If either trigger is released the tool stops.
- To restart the tool, both switches must be released and pressed within one second of each other.

**NOTE:** All settings in Controller → Start Input Configuration will be ignored.

- I/O cannot be used to start a two-handed tool.
  - Latching throttle is disabled for a two-handed tool.
- Exceptions exist for Tubenut tool homing.

### Tubenut Tool Homing Exceptions for Two Handed Functionality

- If controller's tubenut homing configuration is set to RELEASE:
  - Releasing either, or both, of the levers will initiate the homing sequence.
  - Homing will continue until sequence is complete.
- If controller's tubenut homing configuration is set to RELEASE AND REPRESS:
  - Releasing either of the levers, then pressing both levers will initiate the homing sequence.
  - Homing will continue while both of the levers are being pressed.
  - If either lever is released, before homing is complete, tool will stop and homing will pause until both levers are pressed.
  - To restart tool, after homing is complete, both switches must be released and pressed within one second of each other.

## 11. 24 Volt I/O

### Port Pinout and Diagrams

An I/O wiring adapter kit is available (Part #27348) from AIMCO to make connection to I/O port on the controller easier. Contact your AIMCO Sales Representative for ordering information. Toll Free: 1-800-852-1368.



Pin #	Function	Default Assignment
1	Output 1	Accept
2	Output 2	Reject
3	Output 3	In Cycle
4	Output 4	Torque High
5	Outputs 1-4 common	
6	Input 1	Run Forward
7	Input 2	Run Reverse
8	Input 3	Disable Tool
9	Input 4	PSet Bit 1
10	Input 5	PSet Bit 2
11	Input 6	PSet Bit 3
12	Input 7	Reset Job
13	Input 8	
14	Output 5	Torque Low
15	Output 6	Angle High
16	Output 7	Angle Low
17	Output 8	Job Complete
18	Outputs 5-8 common	
19	N/C	
20	N/C	
21	24 V Return	
22	24 V Return	
23	+24 Vdc	
24	+24 Vdc	
25	+24 Vdc	

**NOTE:** The Default Assignments in Table above are factory defaults and can be changed. See "12. Assignable I/O" on page 68.

### 24 Volt I/O Connections

Turn off system before connecting to the LOGIC I/O port. There may be risk of damaging the controller.

- **24Vdc Supply:** The internal 24Vdc power can supply up to 1 amp.
- **Inputs:** Inputs are a sinking configuration with the common connected to the ground pins. 24Vdc is logic ON and 0Vdc is logic OFF.
- **Outputs:** Outputs are normally open relay contacts. The relays are rated for 24Vdc, 1 amp.

**NOTE:** If Outputs are driving an inductive load, such as a solenoid or large relay, it is recommended to add a diode in parallel with the load to prevent voltage surges.

#### LOGIC I/O INPUT CONNECTION EXAMPLE

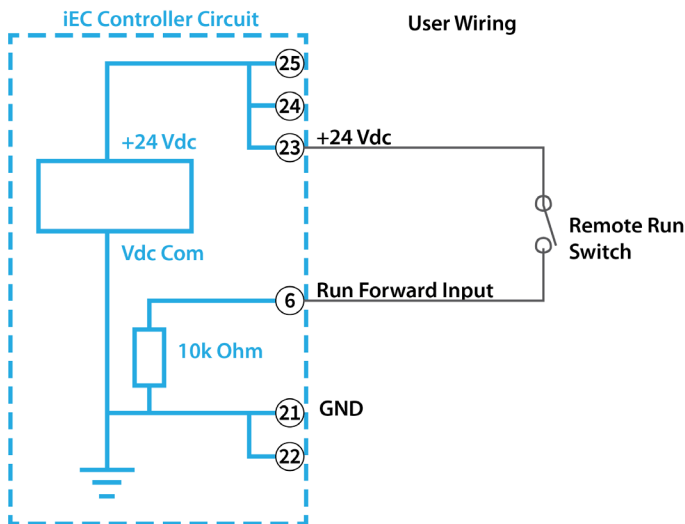

#### LOGIC I/O OUTPUT CONNECTION EXAMPLE

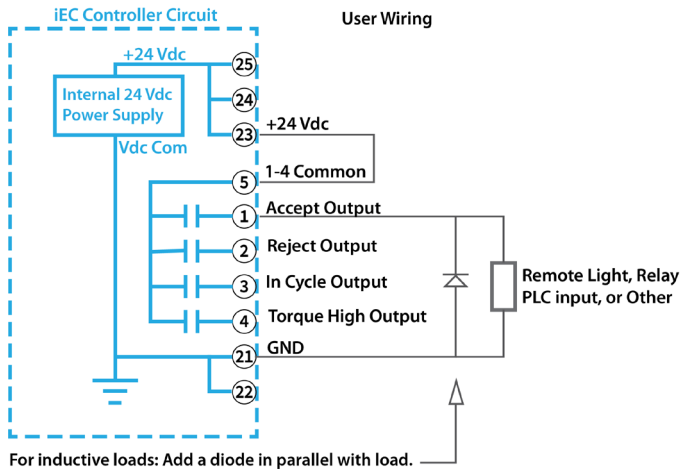

## Importing I/O on an iEC4

These instructions detail how to import I/O into an iEC4 controller via the system port to modify the Anybus outputs.

1. Power on the controller
2. Insert the USB stick into a USB port
3. Connect to the controller via system port and web browser (default address 192.168.1.4)
4. Navigate to Advanced → Import Settings

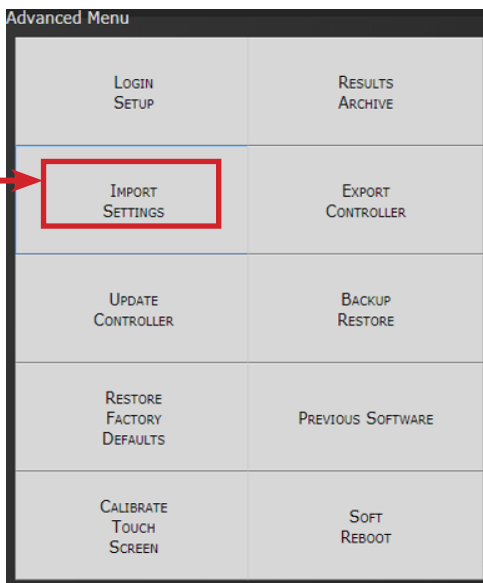

5. Choose file and select **ONLY I/O**

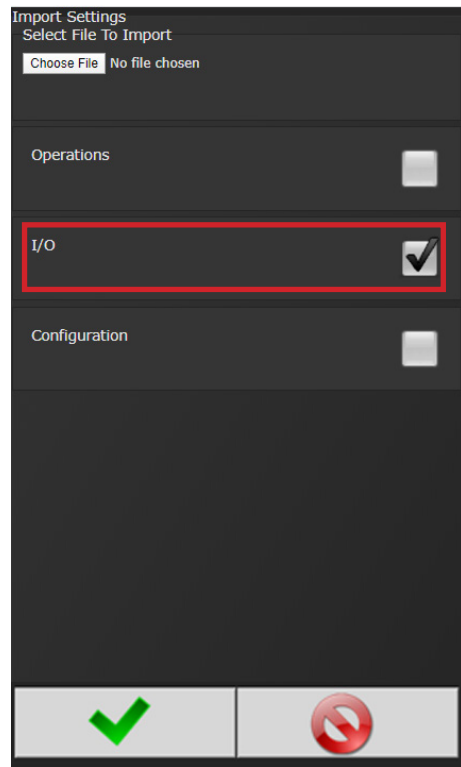

6. Click OK
7. Click OK in the Confirmation dialog box
8. The controller will restart
9. Verify the Anybus outputs.
  - a. Navigate to Controller → IO → Anybus Outputs
  - b. Click on the first row of element #1 and verify it is set as 'Running Job Number', Bit 0, Bits 8, Start at 0.
  - c. Click on element #4 and verify it is set as "Torque (x100)", Bit 0, Bits 16

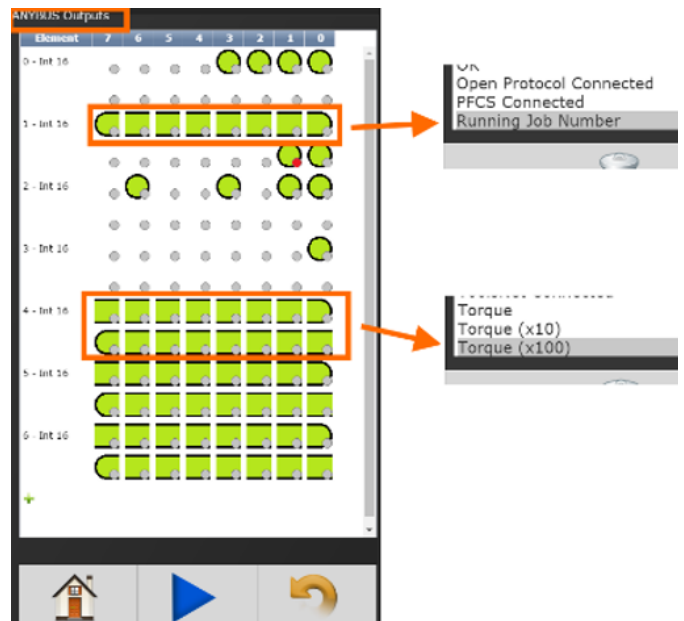

## 12. Assignable I/O

The Gen IV controller supports assignable I/O.

**Buses:** The controller is divided up into buses. Each bus has a set of inputs and a set of outputs. Currently the controller supports the following buses.

Bus Number	Bus
1	Physical I/O
2	Fieldbus (Anybus module) I/O
3	Modbus TCP
4	Ethernet/IP

All assignments have a bus, element, and bit configuration to define its location in the system. The bus value needs to be set from the list above. The element and bit define the location in the bus. The first element on the bus is 0 and goes up the last legal element for the given bus. The bits in each element is referenced from 0(LSB) to 31(MSB).

### Inputs

All input assignments have a Bus, Element, and Bit configuration to define its location in the system. Along with the basic configuration many also have other configuration(s) that allow its behavior to be modified to suit the application.

	Supported Feature						Controllers				
	Bus	Element	Bit 0-31	Polarity N.O./N.C.	Width	Offset	iEC	iAC	iPC	iBC	iBC-Z
Do Nothing	√	√	√				√	√	√	√	√
Start	√	√	√	√			√				
Stop	√	√	√	√			√	√	√	√	
Reverse	√	√	√	√			√				
Disable	√	√	√	√			√	√	√		
Reset Job	√	√	√	√			√	√	√	√	√
Select PSet	√	√	√		√	√	√	√	√	√	
Select Job	√	√	√		√	√	√	√	√	√	√
Select Job Sequence	√	√	√		√	√	√	√	√	√	√
Disable Assembly	√	√	√	√			√				
Set ID	√	√	√		√		√	√	√	√	√
Set ID (word swap)	√	√	√		√		√	√	√	√	√
Set Date/Time	√	√	√		√		√	√	√	√	√
Set Date/Time (word swap)	√	√	√		√		√	√	√	√	√
Verify PSet	√	√	√		√	√	√	√	√	√	√
Clear Results	√	√	√	√			√	√	√	√	√
Log Change	√	√	√		√	√	√	√	√	√	√
Decrement Batch	√	√	√	√			√	√	√	√	√
Increment Batch	√	√	√	√			√	√	√	√	√
Click Wrench	√	√	√	√			√	√	√	√	√
Bypass Stops	√	√	√	√			√	√	√	√	√
Verify Job Sequence	√	√	√		√	√	√	√	√	√	√
ASCII ID	√	√					√	√	√	√	√
Abort Job	√	√	√	√			√	√	√	√	
Remote Start	√	√	√	√			√				
Remove Lock on Reject	√	√	√	√			√	√	√	√	
Dual Start Interlocked	√	√	√	√			√				
Decrement Job	√	√	√	√			√	√	√	√	√
Increment Job	√	√	√	√			√	√	√	√	√
Decrement PSet	√	√	√	√			√	√	√	√	√
Increment PSet	√	√	√	√			√	√	√	√	√
Decrement Job Sequence	√	√	√	√			√	√	√	√	√
Increment Job Sequence	√	√	√	√			√	√	√	√	√

## Polarity

When the polarity is set to N.O. the input is considered active high (24vdc for physical inputs and logic 1 for all network type buses). When the polarity is set to N.C. the input is considered active low (0vdc for physical inputs and logic 0 for all network type buses).

## Width and Offset

For multiple bit inputs (for example "Select PSet") the width variable defines the number of bits the assignment will read for its input. This allows the input size to be restricted to a few bits saving space for other assignments.

The offset variable allows a fixed value to be added to the read value.

For example to use bits 4 & 5 of the physical inputs to select parameter sets 1-4 the assignment would look like...

Select PSet		
Bus	1	For the physical bus
Element	0	For the first element on the bus
Bit	4	For the starting bit location
Width	2	To span the two bits 4 & 5
Offset	1	Adding 1 to the read input value so we get... Binary 00 = 1 Binary 01 = 2 Binary 10 = 3 Binary 11 = 4

## Input Assignments

Do Nothing	Bus	Element	Bit 0-32	Polarity N.O./N.C.	Width	Offset
	√	√	√			
The "Do Nothing" assignment will run do nothing if it is active or inactive.						
Start	Bus	Element	Bit 0-32	Polarity N.O./N.C.	Width	Offset
	√	√	√	√		
The "Start" assignment will run the tool while the input is active. Start is available for the Physical I/O bus only.						
Stop	Bus	Element	Bit 0-32	Polarity N.O./N.C.	Width	Offset
	√	√	√	√		
The "Stop" assignment will stop the tool if it is running and prevent it from being started.						

Reverse	Bus	Element	Bit 0-32	Polarity N.O./N.C.	Width	Offset
	√	√	√	√		
The "Reverse" will put the controller in disassembly mode while the input is active.						
Disable	Bus	Element	Bit 0-32	Polarity N.O./N.C.	Width	Offset
	√	√	√	√		
The "Disable" will disable the tool while the input is active. It will not stop a fastening cycle that is progress.						
Reset Job	Bus	Element	Bit 0-32	Polarity N.O./N.C.	Width	Offset
	√	√	√	√		
On the transition of inactive to active the "Reset Job" assignment will reset the active job.						
Select PSet	Bus	Element	Bit 0-32	Polarity N.O./N.C.	Width	Offset
	√	√	√		√	√
The "Select PSET" input will select the parameter set according to the input value. Uses the width parameter limit the width of the input bits read. The minimum width is 1 and the maximum is 8. After the input is read the offset parameter will be added to the value do get the actual parameter set number. Selecting an invalid parameter set number will disable the tool.						
Select Job	Bus	Element	Bit 0-32	Polarity N.O./N.C.	Width	Offset
	√	√	√		√	√
The "Select Job" input will select the job number according to the input value. Uses the width parameter limit the width of the input bits read. The minimum width is 1 and the maximum is 8. After the input is read the offset parameter will be added to the value do get the actual job number. Selecting an invalid job number will disable the tool.						
Select Job Sequence	Bus	Element	Bit 0-32	Polarity N.O./N.C.	Width	Offset
	√	√	√		√	√
The "Select Job Sequence" input will select the job sequence number according to the input value. Uses the width parameter limit the width of the input bits read. The minimum width is 1 and the maximum is 8. After the input is read the offset parameter will be added to the value do get the actual job sequence number. Selecting an invalid job sequence number or a sequence that is already complete will disable the tool.						

Disable Assembly	Bus	Element	Bit 0-32	Polarity N.O./N.C.	Width	Offset
	√	√	√	√		

The "Disable Assembly" assignment will disable the tool in the assembly direction. It will not disable the tool in disassembly or tube nut homing. It will not stop a fastening cycle that is progress.

Set ID	Bus	Element	Bit 0-32	Polarity N.O./N.C.	Width	Offset
	√	√	√		√	

The "Set ID" assignment will set the ID to an integer value of the input value. The width can be set from 1 to 32 bits. The input value will read as an integer value and an ASCII string with leading zeros will be produced and passed to the ID recognition system. The length of the string is based on the width of the assignment. The string will always be sized to accommodate the maximum value of the input. For example a width setting of 16 can have an integer value of 0-65535 so the produced ID would be "00000" to "65535" (always five character long).

Width setting	Length of ID string	ID value
1 - 3	1	"0" - "n"
4 - 6	2	"00" - "nn"
7 - 9	3	"000" - "nnn"
10 - 13	4	"0000" - "nnnn"
14 - 16	5	"00000" - "nnnnn"
17 - 19	6	"000000" - "nnnnnn"
20 - 23	7	"0000000" - "nnnnnnn"
24 - 26	8	"00000000" - "nnnnnnnn"
27 - 29	9	"000000000" - "nnnnnnnnn"
30 - 32	10	"0000000000" - "nnnnnnnnnn"

Set ID (word swap)	Bus	Element	Bit 0-32	Polarity N.O./N.C.	Width	Offset
	√	√	√		√	

The "Set ID (word swap)" assignment is the same as the "Set ID" assignment except the high and low words (16bit) are swapped prior to evaluation. This is to correct the mixed endianness of some PLC. See the "Set ID" for behavior.

Set Date/Time	Bus	Element	Bit 0-32	Polarity N.O./N.C.	Width	Offset
	√	√	√		√	

The "Set Date/Time" assignment will set the date and time of the controller. The width can be set from 1 to 32 bits but should always be set to 32 to get the correct results. The input value will be read as the number of seconds since 00:00:00 January 1, 1970 (POSIX time or Epoch time). If the input value changes and it is non-zero the date and time of the controller will be set to the new value.

Set Date/Time (word swap)	Bus	Element	Bit 0-32	Polarity N.O./N.C.	Width	Offset
	√	√	√		√	

The "Set Date/Time (word swap)" assignment is the same as the "Set Date/Time" assignment except the high and low words (16bit) are swapped prior to evaluation. This is to correct the mixed endianness of some PLC. See the "Set Date/Time" for behavior.

Verify PSet	Bus	Element	Bit 0-32	Polarity N.O./N.C.	Width	Offset
	√	√	√		√	√

The "Verify PSET" input will compare the current parameter set to the input value. Uses the width parameter limit the width of the input bits read. The minimum width is 1 and the maximum is 8. After the input is read the offset parameter will be added to the value do get the actual parameter set number. If the parameter set input value does not match the current parameter of the controller the tool will be disabled.

Clear Results	Bus	Element	Bit 0-32	Polarity N.O./N.C.	Width	Offset
	√	√	√	√		

The "Clear Results" assignment will clear the latest results outputs (Ok, Nok, etc.) on the same bus.

Log Change	Bus	Element	Bit 0-32	Polarity N.O./N.C.	Width	Offset
	√	√	√		√	√

The "Log Change" assignment will add entries to the controller event log when the input changes.

Decrement Batch	Bus	Element	Bit 0-32	Polarity N.O./N.C.	Width	Offset
	√	√	√	√		

The "Decrement Batch" assignment will remove the latest OK rundown from the current running JOB. This will cause the JOB count to be reduced by one.

Increment Batch	Bus	Element	Bit 0-32	Polarity N.O./N.C.	Width	Offset
	√	√	√	√		

The "Increment Batch" assignment will insert a manual rundown into the current sequence of the current JOB. This will cause the JOB count to increment by one.

Click Wrench	Bus	Element	Bit 0-32	Polarity N.O./N.C.	Width	Offset
	√	√	√	√		

The "Click Wrench" assignment is the same as "Increment Batch" with the addition of a programmable torque value.

Bypass Stops	Bus	Element	Bit 0-32	Polarity N.O./N.C.	Width	Offset
	√	√	√	√		

The "Bypass Stops" assignment removes most stop conditions, allowing the tool to be ran in an override type condition. Hardware faults, stop and disable inputs are not removed.

Verify Job Sequence	Bus	Element	Bit 0-32	Polarity N.O./N.C.	Width	Offset
	√	√	√		√	√

The "Verify Job Sequence" input will compare the current Job sequence to the input value. Uses the width parameter limit the width of the input bits read. The minimum width is 1 and the maximum is 8. After the input is read the offset parameter will be added to the value do get the actual Job sequence number. If the Job sequence input value does not match the current Job sequence of the controller the tool will be disabled.

ASCII ID	Bus	Element	Bit 0-32	Polarity N.O./N.C.	Width	Offset
	√	√				

The "ASCII ID" assignment will set the ID to the of the input (ASCII) value. This assignment consumes the entire element so the Bit is not used. It also has a length parameter to set the length of the input in bytes. The input value will be passed directly to the ID recognition system.

Abort Job	Bus	Element	Bit 0-32	Polarity N.O./N.C.	Width	Offset
	√	√	√	√		

The "Abort Job" assignment aborts the job and disables the tool. A job reset is required to enable the tool for the next job.

Remote Start	Bus	Element	Bit 0-32	Polarity N.O./N.C.	Width	Offset
	√	√	√	√		

The "Remote Start" assignment will run the tool while the input is active. Remote Start is available for non-physical I/O buses.

Remove Lock on Reject	Bus	Element	Bit 0-32	Polarity N.O./N.C.	Width	Offset
	√	√	√	√		

The "Remove Lock on Reject" assignment unlocks the tool if locked on reject, re-enabling the tool.

Dual Start Interlocked	Bus	Element	Bit 0-32	Polarity N.O./N.C.	Width	Offset
	√	√	√	√		

The "Dual Start Interlocked" assignment will run the tool if the interlock conditions are met. Dual Start Interlock is available for the Physical IO bus only. The Dual Start Interlocked input works in combination with the Physical input assigned to the 'Start' input. The Dual Start Interlocked is only available for iEC controllers.

#### Setup

- Only 1 Start Input and 1 Dual Start Interlocked Input should be assigned.
- Controller->Tool Setup -> Start Input Configuration:
  - The Start Input Source Must be set to 'Start From IO'.
  - Latching throttle is disabled for Dual Interlocked Start.

#### Dual Start Interlocked - Operation

- The tool will not run unless both inputs are activated within two seconds of each other.
- If the two second timer times out, both inputs must be deactivated to reset the timer.
- If either input is deactivated the tool stops.
- To restart the tool, both inputs must be deactivated then reactivated within two seconds of each other.

#### TubenuT Tool Homing Exceptions for Dual Start Interlocked functionality

- If controller's tubenuT homing configuration is set to RELEASE:
  - Deactivating either, or both, of the inputs will initiate the homing sequence.
  - Homing will continue until sequence is complete.
- If controller's tubenuT homing configuration is set to RELEASE AND REPRESS:
  - Deactivating either of the inputs, then activating both inputs will initiate the homing sequence.
  - Homing will continue while both inputs are active.
  - If either input is deactivated, before homing is complete, the tool will stop, and homing will pause until both inputs are reactivated.
  - To restart tool, after homing is complete, both inputs must be deactivated, then reactivated within two seconds of each other.

Decrement Job	Bus	Element	Bit 0-32	Polarity N.O./N.C.	Width	Offset
	√	√	√	√		

The "Decrement Job" assignment will decrement the Job Number, selecting the last job if decrementing past the first one.

Increment Job	Bus	Element	Bit 0-32	Polarity N.O./N.C.	Width	Offset
	√	√	√	√		

The "Increment Job" assignment will increment the Job Number, selecting the first job if incrementing past the last one.

Decrement PSet	Bus	Element	Bit 0-32	Polarity N.O./N.C.	Width	Offset
	√	√	√	√		

The "Decrement PSet" assignment will decrement the PSet Number, selecting the last PSet if decrementing past the first one.

Increment PSet	Bus	Element	Bit 0-32	Polarity N.O./N.C.	Width	Offset
	√	√	√	√		

The "Increment PSet" assignment will increment the PSet Number, selecting the first PSet if incrementing past the last one.

Decrement Job Sequence	Bus	Element	Bit 0-32	Polarity N.O./N.C.	Width	Offset
	√	√	√	√		

The "Decrement Job Sequence" assignment will decrement the Job sequence, selecting the last job sequence if decrementing past the first one.

Increment Job Sequence	Bus	Element	Bit 0-32	Polarity N.O./N.C.	Width	Offset
	√	√	√	√		

The "Increment Job Sequence" assignment will increment the Job sequence, selecting the first job if incrementing past the last one.



# AcraDyne Gen IV iEC Controller Manual

## Outputs

All output assignments have a Bus, Element, and Bit configuration to define its location in the system. Along with the basic configuration many also have other configuration(s) that allow its behavior to be modified to suit the application.

	Supported Feature											Controller				
	Bus	Element	Bit 0-32	Polarity N.O./ N.C.	Mode Normal, Timed, Flashed	Time	Width	Offset	Input Bus	Input Element	Input Bit	iEC	iAC	iPC	iBC	iBC-Z
Ok	√	√	√	√	√							√	√	√	√	√
Nok	√	√	√	√	√							√	√	√	√	√
Torque Ok	√	√	√	√	√							√	√	√	√	√
Torque Nok	√	√	√	√	√							√	√	√	√	√
Low Torque	√	√	√	√	√							√	√	√	√	√
High Torque	√	√	√	√	√							√	√	√	√	√
Angle Ok	√	√	√	√	√							√	√	√	√	√
Angle Nok	√	√	√	√	√							√	√	√	√	√
Low Angle	√	√	√	√	√							√	√	√	√	√
High Angle	√	√	√	√	√							√	√	√	√	√
Fastening Complete	√	√	√	√	√							√	√	√	√	√
In Cycle	√	√	√	√	√							√	√	√		
Fastening Aborted	√	√	√	√	√							√	√	√	√	√
Fastening Stopped	√	√	√	√	√							√	√	√	√	√
Batch Complete	√	√	√	√	√							√	√	√	√	√
Job Complete	√	√	√	√	√							√	√	√	√	√
Error	√	√	√	√	√							√	√	√	√	√
Tool Start Switch	√	√	√	√	√							√				
Tool Push to Start Switch	√	√	√	√	√							√				
Tool MFB	√	√	√	√	√							√				
Tool Enabled	√	√	√	√	√							√	√	√	√	√
Tool Running	√	√	√	√	√							√				
Service Indicator	√	√	√	√	√							√	√	√		√
ToolsNet Connected	√	√	√	√	√							√	√	√	√	√
Open Protocol Connected	√	√	√	√	√							√	√	√	√	√
PFCs Connected	√	√	√	√	√							√	√	√	√	√
Running PSet Number	√	√	√				√	√				√	√	√	√	√
Running Job Number	√	√	√				√	√				√	√	√	√	√
External Controlled	√	√	√						√	√	√	√	√	√	√	√
Tool In CCW	√	√	√	√	√							√				
Tool In CW	√	√	√	√	√							√				
Torque	√	√	√				√					√	√	√	√	√
Torque (x10)	√	√	√				√					√	√	√	√	√
Torque (x100)	√	√	√				√					√	√	√	√	√
Angle	√	√	√				√					√	√	√	√	√
Rundown Saved to FTP Server	√	√	√				√					√	√	√	√	√
Fastener Removed	√	√	√	√	√							√	√	√		
Spindle Ok	√	√	√	√	√							√				
Spindle NOK	√	√	√	√	√							√				
Spindle Fastening Complete	√	√	√	√	√							√				
Pulses	√	√	√				√						√	√		√
Pulses High	√	√	√	√	√								√	√		√
Pulses Low	√	√	√	√	√								√	√		√
Pulses NOK	√	√	√	√	√								√	√		√
Pulses Ok	√	√	√	√	√								√	√		√
ON	√	√	√	√	√							√	√	√	√	√
Job Aborted	√	√	√	√	√							√	√	√	√	
Tool In Use	√	√	√	√			√					√	√	√	√	√
Barcode Scanned	√	√	√	√								√	√	√	√	√
Start Trigger Active	√	√	√	√								√				

## Polarity

When the polarity is set to N.O. the output will be high when it is active (24vdc for physical outputs and logic 1 for all network type buses). When the polarity is set to N.C. the output will be low for active (0vdc for physical inputs and logic 0 for all network type buses).

## Mode

### Normal

In the "Normal" mode the output will track the state of the assignment (while still observing the polarity setting). If the polarity is set N.O. and the assignment has an active output the output will be on and stay on till the assignment goes to inactive.

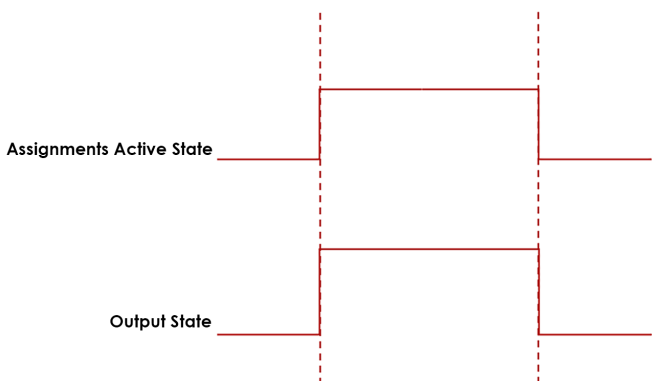

Figure 1: Normal Mode

### Timed

In the "Timed" mode the output will come on when the assignments state goes active and go off based on the time value or the assignment state going inactive (while still observing the polarity setting).

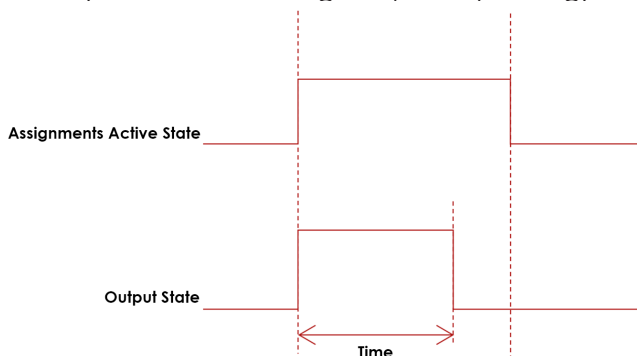

Figure 2 Timed Mode

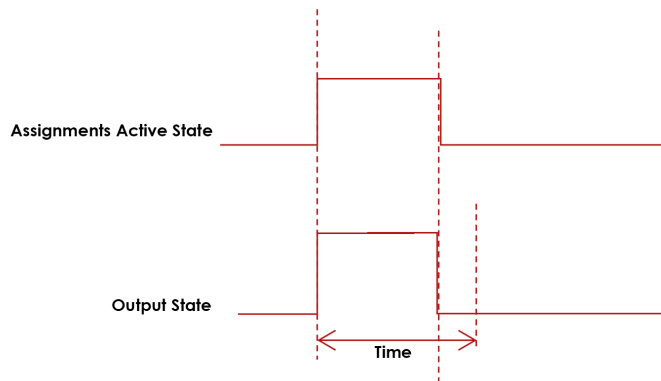

Figure 3: Timed Mode (assignment deactivates before time expires)

### Flash

In the "flash" mode the output will flash at the time rate while the assignments state is active (while still observing the polarity setting).

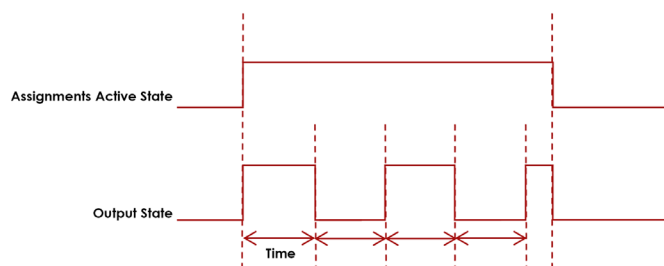

Figure 3 Flash Mode

### Width and Offset

For multiple bit outputs (for example "Running PSet Number") the width variable defines the number of bits the assignment will output. This allows the output size to be restricted to a few bits saving space for other assignments.

The offset variable allows a fixed value to be added to the value before it is output.

For example to use bits 4 & 5 of the physical outputs to indicate the selected parameter set number 1-4 as binary 0-3 the assignment would look like...

Running PSet Number		
Bus	1	For the physical bus
Element	0	For the first element on the bus
Bit	4	For the starting bit location
Width	2	To span the two bits 4 & 5
Offset	-1	Adding -1 to the read input value so we get... 1 = Binary 00 2 = Binary 01 3 = Binary 10 4 = Binary 11

## Output Assignments

	Bus	Element	Bit 0-32	Polarity N.O./N.C.	Mode: Normal, Timed, Flash	Time	Width	Offset	Input Bus	Input Element	Input Bit
<b>OK</b>	√	√	√	√	√						

The “Ok” output assignment will go active at the completion of an acceptable fastening. It will go inactive when the next fastening is started (the torque exceeds the threshold value) or a Job reset.

	Bus	Element	Bit 0-32	Polarity N.O./N.C.	Mode: Normal, Timed, Flash	Time	Width	Offset	Input Bus	Input Element	Input Bit
<b>Nok</b>	√	√	√	√	√						

The “Nok” output assignment will go active at the completion of an unacceptable fastening. It will go inactive when the next fastening is started (the torque exceeds the threshold value) or a Job reset.

	Bus	Element	Bit 0-32	Polarity N.O./N.C.	Mode: Normal, Timed, Flash	Time	Width	Offset	Input Bus	Input Element	Input Bit
<b>Torque Ok</b>	√	√	√	√	√						

The “Torque Ok” output assignment will go active at the completion of a fastening that has an acceptable torque value. It will go inactive when the next fastening is started (the torque exceeds the threshold value) or a Job reset.

	Bus	Element	Bit 0-32	Polarity N.O./N.C.	Mode: Normal, Timed, Flash	Time	Width	Offset	Input Bus	Input Element	Input Bit
<b>Torque Nok</b>	√	√	√	√	√						

The “Torque Nok” output assignment will go active at the completion of a fastening that has an unacceptable torque value. It will go inactive when the next fastening is started (the torque exceeds the threshold value) or a Job reset.

	Bus	Element	Bit 0-32	Polarity N.O./N.C.	Mode: Normal, Timed, Flash	Time	Width	Offset	Input Bus	Input Element	Input Bit
<b>Low Torque</b>	√	√	√	√	√						

The “Low Torque” output assignment will go active at the completion of a fastening that has a low torque results. It will go inactive when the next fastening is started (the torque exceeds the threshold value) or a Job reset.

	Bus	Element	Bit 0-32	Polarity N.O./N.C.	Mode: Normal, Timed, Flash	Time	Width	Offset	Input Bus	Input Element	Input Bit
<b>High Torque</b>	√	√	√	√	√						

The “High Torque” output assignment will go active at the completion of a fastening that has a high torque results. It will go inactive when the next fastening is started (the torque exceeds the threshold value) or a Job reset.

	Bus	Element	Bit 0-32	Polarity N.O./N.C.	Mode: Normal, Timed, Flash	Time	Width	Offset	Input Bus	Input Element	Input Bit
<b>Angle Ok</b>	√	√	√	√	√						

The “Angle Ok” output assignment will go active at the completion of a fastening that has an acceptable angle results. It will go inactive when the next fastening is started (the torque exceeds the threshold value) or a Job reset.

	Bus	Element	Bit 0-32	Polarity N.O./N.C.	Mode: Normal, Timed, Flash	Time	Width	Offset	Input Bus	Input Element	Input Bit
<b>Angle Nok</b>	√	√	√	√	√						

The “Angle Nok” output assignment will go active at the completion of a fastening that has an unacceptable angle results. It will go inactive when the next fastening is started (the torque exceeds the threshold value) or a Job reset.

	Bus	Element	Bit 0-32	Polarity N.O./N.C.	Mode: Normal, Timed, Flash	Time	Width	Offset	Input Bus	Input Element	Input Bit
<b>Low Angle</b>	√	√	√	√	√						

The “Low Angle” output assignment will go active at the completion of a fastening that has a low angle results. It will go inactive when the next fastening is started (the torque exceeds the threshold value) or a Job reset.

	Bus	Element	Bit 0-32	Polarity N.O./N.C.	Mode: Normal, Timed, Flash	Time	Width	Offset	Input Bus	Input Element	Input Bit
<b>High Angle</b>	√	√	√	√	√						

The “High Angle” output assignment will go active at the completion of a fastening that has high angle results. It will go inactive when the next fastening is started (the torque exceeds the threshold value) or a Job reset.

# AcraDyne Gen IV iEC Controller Manual

<b>Fastening Complete</b>	Bus	Element	Bit 0-32	Polarity N.O./N.C.	Mode: Normal, Timed, Flash	Time	Width	Offset	Input Bus	Input Element	Input Bit
	√	√	√	√	√						
The "Fastening Complete" output assignment will go active at the completion of a fastening. It will go inactive when the next fastening is started (the torque exceeds the threshold value) or a Job reset.											
<b>In Cycle</b>	Bus	Element	Bit 0-32	Polarity N.O./N.C.	Mode: Normal, Timed, Flash	Time	Width	Offset	Input Bus	Input Element	Input Bit
	√	√	√	√	√						
The "In Cycle" output assignment will go active at the start of the fastening cycle (the torque exceeds the threshold value). It will go inactive when the fastening cycle ends.											
<b>Fastening Aborted</b>	Bus	Element	Bit 0-32	Polarity N.O./N.C.	Mode: Normal, Timed, Flash	Time	Width	Offset	Input Bus	Input Element	Input Bit
	√	√	√	√	√						
The "Fastening Aborted" output assignment will go active at the completion of a fastening that was aborted by the system. It will go inactive when the next fastening is started (the torque exceeds the threshold value) or a Job reset.											
<b>Fastening Stopped</b>	Bus	Element	Bit 0-32	Polarity N.O./N.C.	Mode: Normal, Timed, Flash	Time	Width	Offset	Input Bus	Input Element	Input Bit
	√	√	√	√	√						
The "Fastening Stopped" output assignment will go active at the completion of a fastening that was stopped by the user. It will go inactive when the next fastening is started (the torque exceeds the threshold value) or a Job reset.											
<b>Batch Complete</b>	Bus	Element	Bit 0-32	Polarity N.O./N.C.	Mode: Normal, Timed, Flash	Time	Width	Offset	Input Bus	Input Element	Input Bit
	√	√	√	√	√						
The "Batch Complete" output assignment will go active at the completion of a fastening that satisfies the bolt count of a Job sequence. It will go inactive when the next fastening is started (the torque exceeds the threshold value) or the job is reset.											
<b>Job Complete</b>	Bus	Element	Bit 0-32	Polarity N.O./N.C.	Mode: Normal, Timed, Flash	Time	Width	Offset	Input Bus	Input Element	Input Bit
	√	√	√	√	√						
The "Job Complete" output assignment will go active at the completion of a fastening that satisfies all the sequences. It will go inactive when the next fastening is started (the torque exceeds the threshold value) or the job is reset.											
<b>Error</b>	Bus	Element	Bit 0-32	Polarity N.O./N.C.	Mode: Normal, Timed, Flash	Time	Width	Offset	Input Bus	Input Element	Input Bit
	√	√	√	√	√						
The "Error" output assignment will be active while the controller has an error.											
<b>Tool Start Switch</b>	Bus	Element	Bit 0-32	Polarity N.O./N.C.	Mode: Normal, Timed, Flash	Time	Width	Offset	Input Bus	Input Element	Input Bit
	√	√	√	√	√						
The "Tool Start Switch" output assignment will reflect the state of the tools start lever.											
<b>Tool Push to Start Switch</b>	Bus	Element	Bit 0-32	Polarity N.O./N.C.	Mode: Normal, Timed, Flash	Time	Width	Offset	Input Bus	Input Element	Input Bit
	√	√	√	√	√						
The "Tool Push to Start Switch" output assignment will reflect the state of the tools push to start switch.											
<b>Tool MFB</b>	Bus	Element	Bit 0-32	Polarity N.O./N.C.	Mode: Normal, Timed, Flash	Time	Width	Offset	Input Bus	Input Element	Input Bit
	√	√	√	√	√						
The "Tool MFB" output assignment will reflect the state of the tools multifunction button.											
<b>Tool Enabled</b>	Bus	Element	Bit 0-32	Polarity N.O./N.C.	Mode: Normal, Timed, Flash	Time	Width	Offset	Input Bus	Input Element	Input Bit
	√	√	√	√	√						
The "Tool Enabled" output assignment will be active if the tool is enabled.											

Tool Running	Bus	Element	Bit 0-32	Polarity N.O./N.C.	Mode: Normal, Timed, Flash	Time	Width	Offset	Input Bus	Input Element	Input Bit
	√	√	√	√	√						
The "Tool Running" output assignment will be active while the tool is running.											
Service Indicator	Bus	Element	Bit 0-32	Polarity N.O./N.C.	Mode: Normal, Timed, Flash	Time	Width	Offset	Input Bus	Input Element	Input Bit
	√	√	√	√	√						
The "Service Indicator" output assignment will be active if the system is in need of service.											
ToolsNet Connected	Bus	Element	Bit 0-32	Polarity N.O./N.C.	Mode: Normal, Timed, Flash	Time	Width	Offset	Input Bus	Input Element	Input Bit
	√	√	√	√	√						
The "ToolsNet Connected" output assignment will be active if the controller has an active connection to a ToolsNet server.											
Open Protocol Connected	Bus	Element	Bit 0-32	Polarity N.O./N.C.	Mode: Normal, Timed, Flash	Time	Width	Offset	Input Bus	Input Element	Input Bit
	√	√	√	√	√						
The "Open Protocol Connected" output assignment will be active if the controller has an active Open protocol connection.											
PFCS Connected	Bus	Element	Bit 0-32	Polarity N.O./N.C.	Mode: Normal, Timed, Flash	Time	Width	Offset	Input Bus	Input Element	Input Bit
	√	√	√	√	√						
The "PFCS Connected" output assignment will be active if the controller has an active PFCS connection.											
Running PSet Number	Bus	Element	Bit 0-32	Polarity N.O./N.C.	Mode: Normal, Timed, Flash	Time	Width	Offset	Input Bus	Input Element	Input Bit
	√	√	√				√	√			
The "Running PSet Number" output assignment will output the current PSet number.											
Running Job Number	Bus	Element	Bit 0-32	Polarity N.O./N.C.	Mode: Normal, Timed, Flash	Time	Width	Offset	Input Bus	Input Element	Input Bit
	√	√	√				√	√			
The "Running Job Number" output assignment will output the current Job number.											
External Controlled	Bus	Element	Bit 0-32	Polarity N.O./N.C.	Mode: Normal, Timed, Flash	Time	Width	Offset	Input Bus	Input Element	Input Bit
	√	√	√						√	√	√
The "External Controlled" output assignment will reflect the state of an input. Use the "Input Bus", "Input Element", and "Input Bit" to specify the input to reflect.											
Tool in CCW	Bus	Element	Bit 0-32	Polarity N.O./N.C.	Mode: Normal, Timed, Flash	Time	Width	Offset	Input Bus	Input Element	Input Bit
	√	√	√	√	√						
The "Tool In CCW" output assignment will be active if the tool is put into disassembly mode and inactive if the tool is in assembly mode.											
Tool in CW	Bus	Element	Bit 0-32	Polarity N.O./N.C.	Mode: Normal, Timed, Flash	Time	Width	Offset	Input Bus	Input Element	Input Bit
	√	√	√	√	√						
The "Tool In CW" output assignment will be active when the is in assembly mode and inactive if the tool is put into disassembly mode.											
Torque	Bus	Element	Bit 0-32	Polarity N.O./N.C.	Mode: Normal, Timed, Flash	Time	Width	Offset	Input Bus	Input Element	Input Bit
	√	√	√				√				
The "Torque" output assignment will output the final torque value of the most recent rundown. The value will be cleared to 0 at the start of a new fastening cycle or a Job reset. At the end of the fastening cycle the final torque will be truncated to an integer and output.											

<b>Torque (x10)</b>	Bus	Element	Bit 0-32	Polarity N.O./N.C.	Mode: Normal, Timed, Flash	Time	Width	Offset	Input Bus	Input Element	Input Bit
	√	√	√				√				
<p>The “Torque (x10)” output assignment will output the final torque value of the most recent rundown. The value will be cleared to 0 at the start of a new fastening cycle or a Job reset. At the end of the fastening cycle the final torque will be multiplied by 10, truncated to an integer and output.</p>											
<b>Torque (x100)</b>	Bus	Element	Bit 0-32	Polarity N.O./N.C.	Mode: Normal, Timed, Flash	Time	Width	Offset	Input Bus	Input Element	Input Bit
	√	√	√				√				
<p>The “Torque (x100)” output assignment will output the final torque value of the most recent rundown. The value will be cleared to 0 at the start of a new fastening cycle or a Job reset. At the end of the fastening cycle the final torque will be multiplied by 100, truncated to an integer and output.</p>											
<b>Angle</b>	Bus	Element	Bit 0-32	Polarity N.O./N.C.	Mode: Normal, Timed, Flash	Time	Width	Offset	Input Bus	Input Element	Input Bit
	√	√	√				√				
<p>The “Angle” output assignment will output the final angle value of the most recent rundown. The value will be cleared to 0 at the start of a new fastening cycle or a Job reset.</p>											
<b>Rundown Saved to FTP Server</b>	Bus	Element	Bit 0-32	Polarity N.O./N.C.	Mode: Normal, Timed, Flash	Time	Width	Offset	Input Bus	Input Element	Input Bit
	√	√	√				√				
<p>The “Rundown Saved to FTP Server” output assignment will output the ID of the last rundown that was saved to the FTP server.</p>											
<b>Fastener Removed</b>	Bus	Element	Bit 0-32	Polarity N.O./N.C.	Mode: Normal, Timed, Flash	Time	Width	Offset	Input Bus	Input Element	Input Bit
	√	√	√	√	√						
<p>The “Fastener Removed” output assignment will go active when a fastener is removed by the operator. The controller must be configured to report disassembly for this output to work. It will go inactive when the next fastening is started (the torque exceeds the threshold value) or a Job reset.</p>											
<b>Spindle OK</b>	Bus	Element	Bit 0-32	Polarity N.O./N.C.	Mode: Normal, Timed, Flash	Time	Width	Offset	Input Bus	Input Element	Input Bit
	√	√	√	√	√						
<p>The “Spindle Ok” output assignment will go active at the completion of multi-spindle fastening if all spindles have an OK. It will go inactive when the next fastening is started (the torque exceeds the threshold value) or a Job reset.</p>											
<b>Spindle NOk</b>	Bus	Element	Bit 0-32	Polarity N.O./N.C.	Mode: Normal, Timed, Flash	Time	Width	Offset	Input Bus	Input Element	Input Bit
	√	√	√	√	√						
<p>The “Spindle NOK” output assignment will go active at the completion of multi-spindle fastening if one or more of the spindles have an NOK. It will go inactive when the next fastening is started (the torque exceeds the threshold value) or a Job reset.</p>											
<b>Spindle Fastening Complete</b>	Bus	Element	Bit 0-32	Polarity N.O./N.C.	Mode: Normal, Timed, Flash	Time	Width	Offset	Input Bus	Input Element	Input Bit
	√	√	√	√	√						
<p>The “Spindle Fastening Complete” output assignment will go active at the completion of multi-spindle fastening. It will go inactive when the next fastening is started (the torque exceeds the threshold value) or a Job reset.</p>											
<b>Pulses</b>	Bus	Element	Bit 0-32	Polarity N.O./N.C.	Mode: Normal, Timed, Flash	Time	Width	Offset	Input Bus	Input Element	Input Bit
	√	√	√				√				
<p>The “Pulses” output assignment will output the pulse count value of the most recent rundown. The value will be cleared to 0 at the start of a new fastening cycle or a Job reset.</p>											
<b>Pulses High</b>	Bus	Element	Bit 0-32	Polarity N.O./N.C.	Mode: Normal, Timed, Flash	Time	Width	Offset	Input Bus	Input Element	Input Bit
	√	√	√	√	√						
<p>The “Pulses High” output assignment will go active at the completion of a fastening that has a pulse count that exceeds the high limit. It will go inactive when the next fastening is started (the torque exceeds the threshold value) or a Job reset.</p>											

Pulses Low	Bus	Element	Bit 0-32	Polarity N.O./N.C.	Mode: Normal, Timed, Flash	Time	Width	Offset	Input Bus	Input Element	Input Bit
	√	√	√	√	√						

The "Pulses Low" output assignment will go active at the completion of a fastening that has an pulse count that falls below the low limit. It will go inactive when the next fastening is started (the torque exceeds the threshold value) or a Job reset.

Pulses NOK	Bus	Element	Bit 0-32	Polarity N.O./N.C.	Mode: Normal, Timed, Flash	Time	Width	Offset	Input Bus	Input Element	Input Bit
	√	√	√	√	√						

The "Pulses Ok" output assignment will go active at the completion of a fastening that has an acceptable pulse count. It will go inactive when the next fastening is started (the torque exceeds the threshold value) or a Job reset.

Pulses Ok	Bus	Element	Bit 0-32	Polarity N.O./N.C.	Mode: Normal, Timed, Flash	Time	Width	Offset	Input Bus	Input Element	Input Bit
	√	√	√	√	√						

The "Pulses NOK" output assignment will go active at the completion of a fastening that has an unacceptable pulse count. It will go inactive when the next fastening is started (the torque exceeds the threshold value) or a Job reset.

ON	Bus	Element	Bit 0-32	Polarity N.O./N.C.	Mode: Normal, Timed, Flash	Time	Width	Offset	Input Bus	Input Element	Input Bit
	√	√	√	√	√						

The "ON" output assignment will be active when the controller is powered up and remains active until power down.

Job Aborted	Bus	Element	Bit 0-32	Polarity N.O./N.C.	Mode: Normal, Timed, Flash	Time	Width	Offset	Input Bus	Input Element	Input Bit
	√	√	√	√	√						

The "Job Aborted" output assignment will go active if a Job is aborted. It will go inactive when the job is reset.

Tool In Use	Bus	Element	Bit 0-32	Polarity N.O./N.C.	Mode: Normal, Timed, Flash	Time	Width	Offset	Input Bus	Input Element	Input Bit
	√	√	√	√		√					

The "Tool In Use" output assignment will go active when the trigger is pressed, whereupon a timer will restart. It will go inactive when the specified time is reached without becoming active in between.

Barcode Scanned	Bus	Element	Bit 0-32	Polarity N.O./N.C.	Mode: Normal, Timed, Flash	Time	Width	Offset	Input Bus	Input Element	Input Bit
	√	√	√	√							

The "Barcode Scanned" output assignment will go active when a barcode is scanned. The ID # (1-4) will activate the corresponding bit, if it is covered by the number of bits configured. The maximum size is 4 bits. All bits will go inactive when a tool reaches the InCycle threshold of a rundown or when they are reset.

Start Trigger Active	Bus	Element	Bit 0-32	Polarity N.O./N.C.	Mode: Normal, Timed, Flash	Time	Width	Offset	Input Bus	Input Element	Input Bit
	√	√	√	√							

The 'Start Trigger Active' assignment will reflect the state of the active Start Input configured to run the tool.

Possible Start Inputs include:

- Start from IO
  - Start
  - Dual Start Interlocked
- Start from Tool Buttons
  - Lever and/or PTS
  - Dual Levers Interlocked
  - Start from Master Tool
  - Start from Remote Start
  - Latched Throttle

Start Trigger Active is available for the iEC Controller Only.

13. Controller Supported MIDs

Supported MID			
MID	Description	Revisions	Note
1	Communication start	1,2,3	
2	Communication start acknowledge	1,2,3	
3	Communication stop		
4	Command error		
5	Command accepted		
8	Application data subscribe		Support MID 900 curve data only
9	Application data unsubscribe		Support MID 900 curve data only
10	Parameter set ID upload request		
11	Parameter set ID upload reply		
12	Parameter set data upload request		
13	Parameter set data upload reply		Always returns a batch size of 0
14	Parameter set selected subscribe		
15	Parameter set selected		
16	Parameter set selected acknowledge		
17	Parameter set selected unsubscribe		
18	Select Parameter set		
19	Set Parameter set batch size		
20	Reset Parameter set batch counter		
30	Job ID upload request		
31	Job ID upload reply		
34	Job info subscribe		
35	Job info		
36	Job info acknowledge		
37	Job info unsubscribe		
38	Select Job		
39	Job restart		
40	Tool data upload request	1,2	
41	Tool data upload reply		
42	Disable tool		
43	Enable tool		
50	Vehicle ID number download request		
51	Vehicle ID number subscribe	1,2	
52	Vehicle ID number	1,2	Has an option to send w/without IDs
53	Vehicle ID number acknowledge		
54	Vehicle ID number unsubscribe		
60	Last tightening result data subscribe	1-6,999	
61	Last tightening result data		
62	Last tightening result data acknowledge		
63	Last tightening result data unsubscribe		
64	Old tightening result upload request		

Supported MID			
MID	Description	Revisions	Note
65	Old tightening result upload reply		
70	Alarm subscribe		
71	Alarm		
72	Alarm acknowledge		
73	Alarm unsubscribe		
76	Alarm status		
77	Alarm status acknowledge		
80	Read time upload request		
81	Read time upload reply		
82	Set time		
90	Multi spindle status subscribe		
91	Multi spindle status		
92	Multi spindle status acknowledge		
93	Multi spindle status unsubscribe		
100	Multi spindle results subscribe		
101	Multi spindle results		
102	Multi spindle results acknowledge		
103	Multi spindle results unsubscribe		
113	Flash green light on tool		
127	Abort Job		
128	Job batch increment		
129	Job batch decrement		
130	Job off		
150	Identifier download request		
157	Reset all Identifiers		
200	Set external controlled relays		Only supports 0 (off) and 1 (on)
210	Status external monitored inputs subscribe		
211	Status external monitored inputs		
212	Status external monitored inputs acknowledge		
213	Status external monitored inputs unsubscribe		
214	IO device status request	1,2	
215	IO device status reply		
216	Relay function subscribe		See supported relay functions below.
217	Relay function		
218	Relay function acknowledge		
219	Relay function unsubscribe		
241	User data subscribe		Out_1 - Pulse status (0= OK, 1 = Low, 2 = High)
242	User data		
243	User data acknowledge		
244	Relay function unsubscribe		Out_2 - Pulses Out_3 - Undefined Out_4 - Undefined
900	Trace data		Trace type 1 & 2 only (angle & torque)
9999	Keep alive open protocol communication		

Supported Relay Functions

Supported Relay Functions Number	Function
1	OK
2	NOK
5	Low Torque
6	High Torque
7	Low angle
8	High angle

Supported Relay Functions Number	Function
9	Cycle complete
10	Alarm
11	Batch NxOK
12	Job OK
19	Tool ready
20	Tool start switch

Supported Relay Functions Number	Function
21	Dir. switch = CW
22	Dir. switch = CCW
26	Tool running
145	Start Trigger Active
276	Cycle abort



14. Dimensions

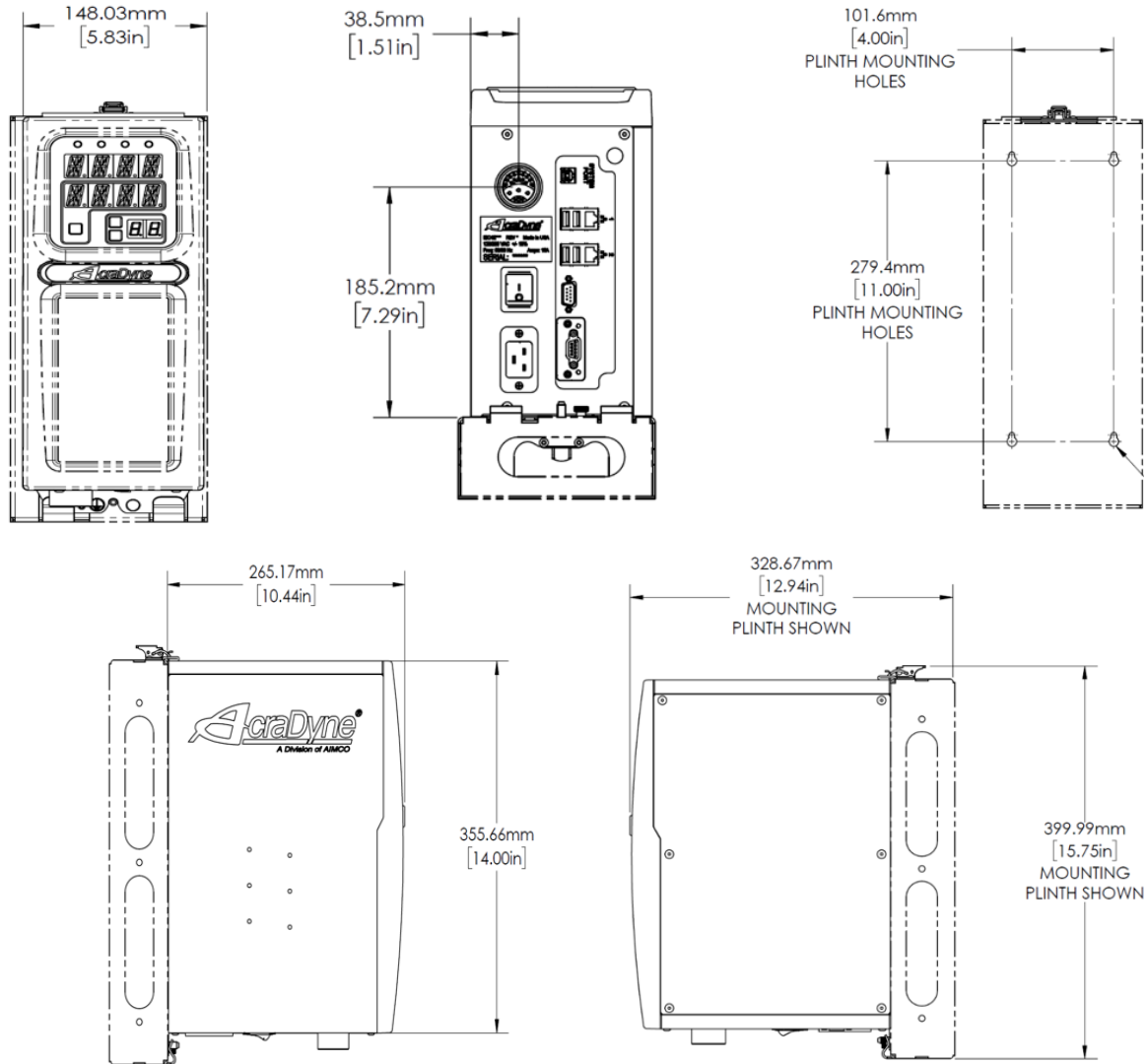

15. Specifications

**Mechanical:**

Dimensions	Width:	6.25 in	159 mm
	Height:	15.75 in	400 mm
	Depth:	12.5 in	316 mm
Weight:		15.65 lbs	7.1 kg

**Operating Conditions:**

Temperature:	32 to 122 °F (0 to 50 °C)
Humidity:	Non-condensing
Ingress Protection:	IP20

**Electrical:**

AC Power Source:	
120 VAC, 1Φ, 50/60 Hz.	15 - 20A dedicated service
230 VAC, 1Φ, 50/60 Hz.	10 - 15A dedicated service (Recommended for high duty cycle applications)

**Standards:**

<b>Safety Compliance:</b>
EC Machinery Directive 2006/42/EC
EC Low Voltage Directive 2006/95/EC
EN 12100-1; EN 12100-12 Safety of Machinery
EN 60745-1; EN 60745-2-2 Hand-held motor operated tools
<b>EMC</b>
EC Directive of Electromagnetic Compatibility 2004/108/EC
EN 61000-6-4; EN 6100-6-2; Class A
<b>RoHs</b>
Reduction of Hazardous Substances 2002/95/EC
<b>Markings</b>
CE



If attempting to use tooling below 0°C, allow the system to warm up by running in a no-load state until acceptable temperatures are reached.

## 16. Tubenut Tool Setup Details

### 16.1 Overview

The following describes the setup required for tubenut tool operation. This includes determining the values for tubenut specific TID parameters (parameters residing in the tool memory) and Gen IV controller parameters.

### 16.2 Tubenut Homing

#### 16.2.1 Tubenut Home TID parameters

The tubenut TID parameters can be viewed and modified from the Tool → Tool Setup screen. The tool to be configured must be connected to the controller.

- **Home Detection Torque - Home (in\*Lb)**
  - When tool is homing, reaching this torque indicates to controller that the tool output socket has reached the Home stop and is in the open position.
  - If tool output does not attempt to return, or does not completely reach the Home position, this value is too low.
 

**NOTE:** Setting this value too high can potentially damage the tool.
  - Units: lbf-in
  - TID memory location: 53
- **Hold at Home Torque - Open Loop (in\*Lb)**
  - After reaching the Home position, this torque is applied against the Home stop to prevent socket from bouncing to a partially closed position.
  - This value is typically set to a value slightly lower than the Home detection torque.
  - If socket is bouncing back to a partially closed position, after reaching the Home stop, this value is too low.
 

**NOTE:** Setting this value too high can cause the socket to snap back to the Home stop too quickly and potentially damage the tool.
  - Units: lbf-in (approximation)
  - TID memory location: 54

### 16.3 Setting the Tool's Tubenut Home TID Parameters

- Set the Hold at Home Torque = 0
- Set the Home Detection Torque = 1
- Free-run tool and watch the homing routine while making the adjustments below.
- Gradually increase the value for the Home Detection Torque until tool reliably returns to the Home position.

- When a good value for the Home Detection Torque is found, if the tool is bouncing back to a partially closed position after hitting the Home stop, gradually increase the value for the Hold at Home Torque until bounce back is eliminated.

### 16.4 Controller Parameters Affecting Tubenut Homing

Controller parameters for tubenut operation can be viewed and modified from the Controller → Tool Setup → Disassembly and Tubenut screen.

- **Tubenut Homing Max Speed:**
  - Speed the tool output socket travels when returning to the Home position.
  - Decreasing this can reduce the impact force when hitting the Home stop.
 

**NOTE:** Care must be taken, increasing the speed above the default value; too high of a value can greatly increase how hard the output will hit the Home stop and potentially damage the tool.
  - Units: RPM of the tool output socket in the homing direction.
  - Default value: 50 RPM
  - Range: 1 to 200 RPM
- **Tubenut Homing Acceleration:**
  - Rate at which speed of tool ramps to the homing speed.
  - Units: kRPM/second
  - Default value: 0.5 seconds
  - Range: 0.1 to 10 seconds
- **Tubenut Homing Reverse Dwell Time:**
  - Amount of time before the output is allowed to Home, after rundown is complete and tool lever is released.
  - Units: Seconds
  - Default value: 0.5 seconds
  - Range: 0 to 2 Seconds
- **Tubenut Home Dwell Time:**
  - Amount of time tool holds at Home to prevent bounce back
  - Too short of Home dwell time can increase the occurrence of bounce back. However, decreasing the homing speed can decrease the severity of bounce back after the Home stop is reached and allow for a shorter dwell time.
  - Units: Seconds
  - Default value: 0.5 Seconds
  - Range: 0 to 2 Seconds

## 16.5 Tubenut Pinch Detection

### 16.5.1 Obstruction Detection TID Parameters

The tubenut TID parameters can be viewed and modified from the Tool → Tool Setup screen. The tool to be configured must be connected to controller.

- Obstruction Detection Torque - (**in\*Lb**)
  - At start of rundown, before the output rotation has passed through the Obstruction Check Zone (where output is open at the start of the fasting cycle), the tool will stop and fastening cycle will be aborted if this torque is exceeded.
  - If tool stops, when output is open during this first part of the rundown, without any obstruction, the value is too low.
  - Units: lbf-in
  - TID memory location: 53

### 16.5.2 Setting the Tool's Tubenut Obstruction Detection

#### Parameters

- Set value for the obstruction torque just high enough so tool will reliably overcome gear friction and make it past the obstruction checking zone.
- Check torque of the stop on obstruction feature by measuring the actual "pinch" torque the tube nut produces at the start of the rundown when the jaws are open (within the obstruction detection angle range). This can be done on a semi-tightened joint simulator set for a hard joint, while auditing the torque.
 

**NOTE:** Gear friction in the tubenut head can greatly affect the ability to reliably detect an obstruction.

### 16.5.3 Controller Parameters Affecting Tubenut Pinch Detection

Controller parameters for tubenut operation can be viewed and modified from the Controller → Tool Setup → Disassembly and Tubenut screen.

- Obstruction Check Angle
  - Angle of travel from start of fasting cycle where, if an obstruction is detected inside this zone, the tool will stop and the fastening cycle will be aborted.
  - Units: Degrees of rotation of the output from Home to where the output is closed.
  - Default value: 90 Degrees
  - Range: 0 to 180 Degrees
- Obstruction Check Speed Limit

- Maximum speed output will run during the check for obstructions.
- Decreasing this can reduce the impact force when hitting an obstruction.
 

**NOTE:** Care must be taken increasing the speed above the default value. Too high of a value can greatly increase how hard the output will hit the obstruction.
- Units: RPM of the tool output
- Default: 70 RPM
- Range: 1 to 200 RPM
- Obstruction Check Acceleration Limit
  - Rate at which the speed of the tool ramps to Obstruction Check Speed.
  - Units: kRPM/second
  - Default value: 0.5
  - Range: 0.1 to 10

### 16.5.4 Tubenut Homing Start Input Logic Selection

The controller parameter for tubenut homing Start Input Logic can be viewed and modified from the controller → Tool Setup → Start Input screen.

- Tubenut Homing Start Input logic:
  - Lever action required to start the Home sequence.
  - Options:
- Home on release and repress of the lever (default)
- Home on release of the lever

## 17. Troubleshooting

### **Issue: LED Frozen Showing "Initializing"**

**Solution:** The rear SD card containing the system UI may have become unseated. Turn off controller power. Depending on vintage, remove the label or cover plate to access the card slot. Gently depress the card and release to unseat it. Gently then press the card into the slot until feeling and hearing the locking click indicating it is secure. Replace the label or cover plate and power the controller back on.

### **Issue: System Port IP Connectivity using USB Cabling**

**Solution:** In most cases, connectivity will be automatic when connection between the controller SYSTEM PORT and a PC USB Port are made. Confirmation of the connection is noted by the presence of a USB Ethernet/RNDIS Gadget in the PC Adapter list. Should this connection not be established, specific instructions are located at the product manuals page at <https://www.aimco-global.com/manuals> under the heading **System Port Connectivity Troubleshooting for PCs**.

## 18. AIMCO Warranty

### **NEW TOOL AND ACCESSORY WARRANTY**

Any new tool or accessory branded with the AIMCO, Uryu, AcraDyne or Eagle Group name, and purchased from AIMCO, or through one of its authorized distributors or agents, is warranted to the original buyer against defects in materials and workmanship for a period of one (1) year\* from date of delivery. Under the terms of this warranty, AIMCO agrees, without charge, to repair or replace, at its option and Ex-Works (EXW) its authorized service centers, any product or accessory warranted hereunder proving to AIMCO's satisfaction to be defective as a result of defective workmanship or material. In order to qualify for this warranty, written notice to AIMCO must be given immediately upon discovery of such defect, at which time AIMCO will issue an authorization to return the tool. The defective item must be promptly returned to an authorized AIMCO service center with all freight charges prepaid.

### **REPAIRED TOOL WARRANTY**

Once a tool is beyond the new product warranty period as detailed above, AIMCO will provide repair subject to the following warranty periods: pneumatic tools: 90 days\*; electric tools and Acra-Feed: 90 days; battery tools: 30 days\*; DC Electric tools: 90 days\*

### **EXCLUSION FROM WARRANTY**

This warranty is valid only on products purchased from AIMCO, or through its authorized distributors or agents. AIMCO shall have no obligation pursuant to the AIMCO Warranty with respect to any tools or accessories which in AIMCO's sole judgment have been altered damaged, misused, abused, badly worn, lost or improperly maintained. This Warranty is null and void if the customer, or any other person other than an authorized representative of AIMCO, has made any attempt to service or modify the tool or accessory prior to its return to AIMCO under this Warranty.

The warranty provision with respect to each such product may be amended by AIMCO from time to time in its sole discretion. The liability of AIMCO hereunder shall be limited to replacing or repairing, at its option, any defective products which are returned freight pre-paid to AIMCO or, at AIMCO's option, refunding the purchase price of such products.

AIMCO reserves the right to make periodic changes in construction or tool design at any time. AIMCO specifically reserves the right to make these changes

without incurring any obligation or incorporating such changes or updates in tools or parts previously distributed.

THE AIMCO WARRANTY IS IN LIEU OF ALL OTHER WARRANTIES, EXPRESSED OR IMPLIED, AND AIMCO EXPRESSLY DISCLAIMS ANY WARRANTY OF MERCHANTABILITY OR FITNESS FOR A PARTICULAR PURPOSE. THIS WARRANTY SETS FORTH THE SOLE AND EXCLUSIVE REMEDY IN CONTRACT, TORT, STRICT LIABILITY, OR OTHERWISE.

THIS WARRANTY IS THE ONLY WARRANTY MADE BY AIMCO WITH RESPECT TO THE GOODS DELIVERED HEREUNDER, AND MAY BE MODIFIED OR AMENDED ONLY BY A WRITTEN INSTRUMENT SIGNED BY A DULY AUTHORIZED OFFICER OF AIMCO.

### **LIMITATION OF LIABILITY**

AIMCO'S LIABILITY PURSUANT TO WARRANTY OF THE PRODUCTS COVERED HEREUNDER IS LIMITED TO REFUND OF THE PURCHASE PRICE. IN NO EVENT SHALL AIMCO BE LIABLE FOR COSTS OF PROCUREMENT OF SUBSTITUTE GOODS BY THE BUYER. IN NO EVENT SHALL AIMCO BE LIABLE FOR ANY SPECIAL, CONSEQUENTIAL, INCIDENTAL OR OTHER DAMAGES (INCLUDING WITHOUT LIMITATION, LOSS OF PROFIT) WHETHER OR NOT AIMCO HAS BEEN ADVISED OF THE POSSIBILITY OF SUCH LOSS, HOWEVER CAUSED, WHETHER FOR BREACH OR REPUDIATION OF CONTRACT, BREACH OF WARRANTY, NEGLIGENCE OR OTHERWISE. THIS EXCLUSION ALSO INCLUDES ANY LIABILITY WHICH MAY ARISE OUT OF THIRD PARTY CLAIMS AGAINST BUYER. THE ESSENTIAL PURPOSE OF THIS PROVISION IS TO LIMIT THE POTENTIAL LIABILITY OF AIMCO ARISING OUT OF THIS AGREEMENT AND/OR SALE.

**NOTE:** The AIMCO Warranty confers specific legal rights, however some states or jurisdictions may not allow certain exclusions or limitations within this warranty. **\*Note – All warranty periods addressed herein are determined using a standard shift, eight-hour work day.**







**AIMCO CORPORATE HEADQUARTERS**  
10000 SE Pine Street  
Portland, Oregon 97216  
Phone: (503) 254-6600  
Toll Free: 1-800-852-1368

**AIMCO CORPORATION DE MEXICO SA DE CV**  
Ave. Cristobal Colon 14529  
Chihuahua, Chihuahua. 31125  
Mexico  
Phone: (01-614) 380-1010  
Fax: (01-614) 380-1019