

# AUDITOR



## TORQUE MEASUREMENT SOLUTIONS *2022*



**AIMCO**

For more than 50 years, AIMCO has been working with manufacturers around the world. We are the complete global source for all critical fastening and bolting solutions. AIMCO can effectively and swiftly meet your needs whether you're in Tennessee, USA fastening a 3 mm nut at 3 Nm, or in Denmark servicing wind-turbine bolts at 17,000 Nm. AIMCO provides the tools and solutions, on a global scale, that guarantee the success of your project. It is with great pride that AIMCO can say the products that we manufacture are **MADE IN THE USA.**

Visit our website [www.aimco-global.com](http://www.aimco-global.com)

# TABLE OF CONTENTS

---

## TORQUE MEASUREMENT

Torque Measurement Overview. . . . .	4
Torque Measurement Systems . . . . .	7
Torque Measurement Testers . . . . .	8
Torque Measurement Analyzers . . . . .	11
Auditor Data Collection Software. . . . .	14
High-Capacity Test Stands. . . . .	15
Torque Wrenches . . . . .	19
iTVC Torque Carts . . . . .	24
Transducers. . . . .	25
Joint Kits / Joint Simulators . . . . .	28
Torque Measurement Cables . . . . .	29
<b>Index . . . . .</b>	<b>30</b>

# Torque Measurement: Overview

Torque measurement and the verification of torque tools and applied torque are an integral part of today's threaded assembly process. The method used to measure torque can affect the judgments made regarding tool performance, assembly processes and overall product quality.

## DYNAMIC TORQUE

Dynamic torque is the torque produced during the actual tightening process, normally measured using rotary transducers and a torque analyzer.

### Advantages:

- Reduces operator influence
- Measures applied torque
- Can also include angle of rotation as error proofing parameter

## RESIDUAL TORQUE

Residual torque is the torque measured by producing an incremental amount of movement of the fastener after the actual tightening process, normally measured using a dial or digital torque wrench.

### Advantages:

- Easy access to fastener
- Error proofing
- Can detect missed fasteners or joints with significant relaxation

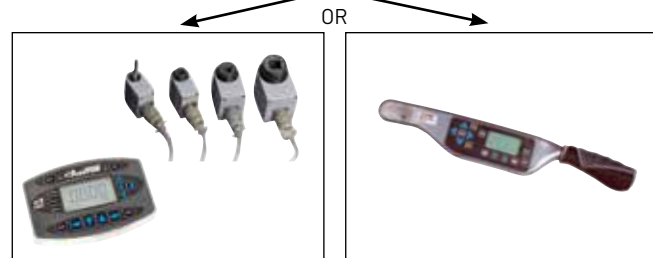
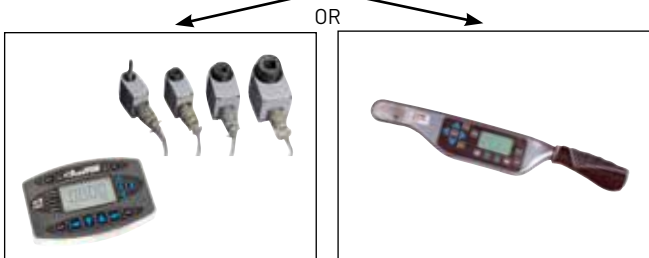
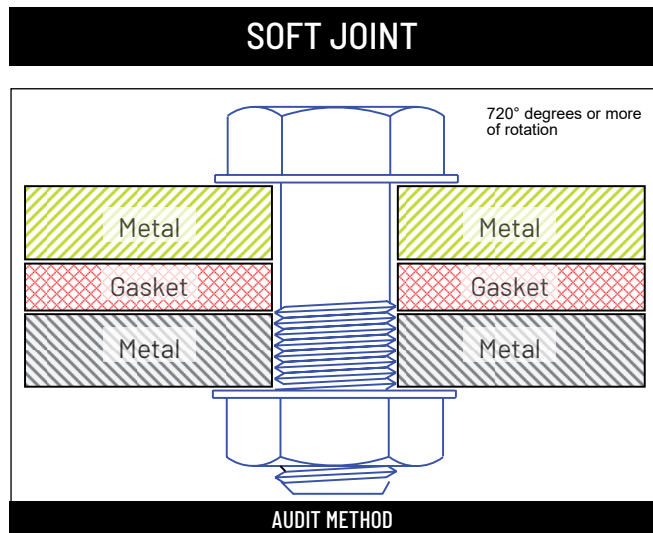
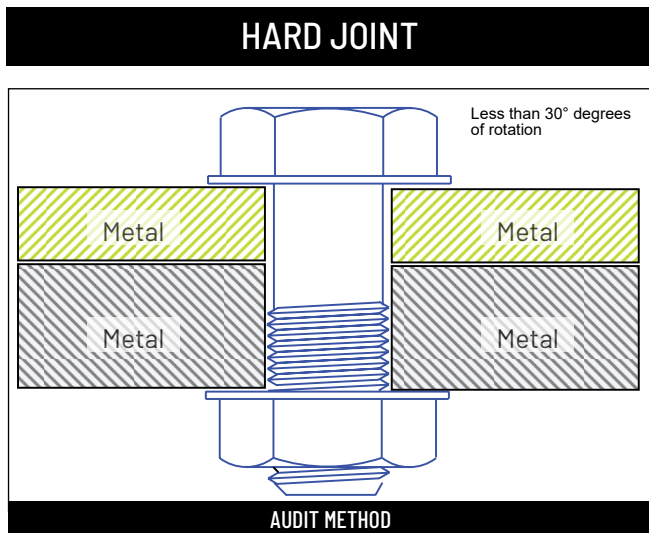

Dynamic Torque: 15 Nm

Residual Torque: 18 Nm

Dynamic Torque: 15 Nm

Residual Torque: 12 Nm

Values as examples only

Values as examples only

A hard joint, one requiring a low degree of rotation during tightening, will normally show very little relaxation after tightening. Due to the high amount of remaining clamp load and friction within the joint members, additional movement of the fastener requires additional torque energy to be applied. Therefore, Residual Torque values will be higher than Dynamic Torque values.

A soft joint, one requiring a high degree of rotation during tightening, will normally show significant amounts of relaxation after tightening. Relaxation leads to a loss of clamp load and friction within the joint members. Due to this relaxation, additional movement of the fastener requires relatively small amounts of additional torque energy and Residual Torque values will be lower than Dynamic Torque values.

# Torque Measurement: Overview

Checking torque measurement before, during, and after assembly ensures quality manufacturing. Proper torque measurement is critical in many assembly operations. AIMCO utilizes years of experience to design a process around your specific auditing requirements. From simple dial wrenches to electronic data collectors and joint analyzers for R&D, AIMCO is with you every step of the way.

## BEFORE ASSEMBLY

### Tool Capability



#### Is the tool working correctly?

Testing and verifying tools under controlled conditions helps you identify accuracy and repeatability before using them in production.

#### Equipment used:

- Desktop testers with internal transducers
- Auditor analyzers with either stationary or rotary transducers
- UFT hydraulic joint simulators and rotary transducers

## DURING ASSEMBLY

### Process Capability



#### How does the tool work with the product being assembled?

Testing the tools during the actual process helps ensure that the process is working correctly. Variables in the parts and influences from the operator can be accounted for.

#### Equipment used:

- Torque Data Collectors/ Analyzers
- Auditor Rotary Transducers

## AFTER ASSEMBLY

### Product Capability



#### Does the finished product meet expectations?

Checking the product after assembly is the final opportunity to verify that product quality is satisfactory before user delivery

#### Equipment used:

- Click/Dial wrenches
- Electronic wrenches with Auditor analyzers
- Rotary transducers and Auditor analyzers with hand driver to move fastener



# Torque Measurement: Overview

## MEASURING QUALITY – PROCESS CAPABILITY

### Statistical Analysis Is An Important Step In Any Quality Control Process

One of the most widely accepted statistical indicators of process quality, and therefore product quality, is Cpk, or the process capability for a centered process. This value indicates how capable a process is and whether the results of that process are properly centered near a specific target. A capable process is one that approaches, as a limit, 100% conformance to specifications.

Cpk is a statistical value that indicates how tightly grouped a series of samples is around the target value. Cpk is a function of the Upper Specification Limit (USL), the Lower Specification Limit (LSL), the mean of the samples and the standard deviation ( $\sigma$ ) of the samples.

$$Cpk = \text{either } \frac{(USL - \text{Mean})}{(3 \times \sigma)} \text{ or } \frac{(\text{Mean} - LSL)}{(3 \times \sigma)}, \text{ whichever is smaller.}$$

An acceptable, or capable, process will normally have a Cpk value of at least 1.33.

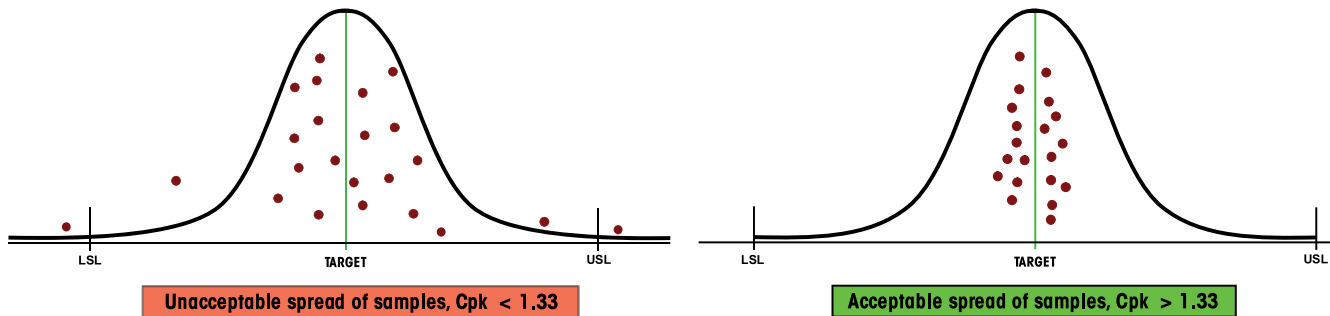

## MEASURING QUALITY – CLAMP LOAD

The purpose of threaded fastening is to produce the correct amount of clamp load within the joint.

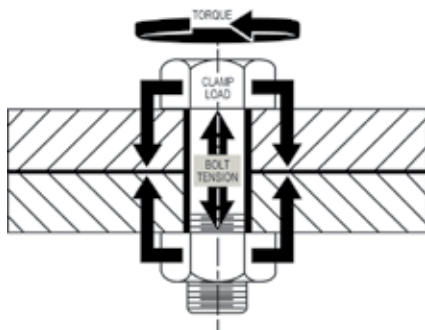

Due to the cost and difficulty of measuring clamp load during the actual assembly process, torque is used as the control parameter during tightening. Many manufacturers use torque values as the primary indicator of threaded assembly quality. However, achieving repeatable clamp load is a better indicator of joint quality.

Studies have shown that discontinuous drive tools can produce equal or better clamp load results when compared to continuous drive tools.

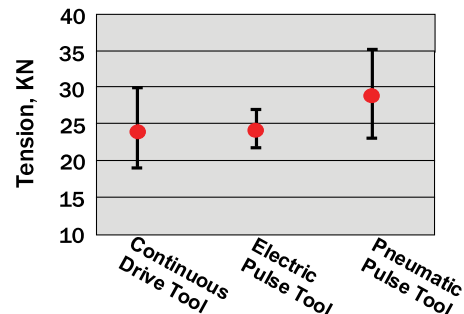
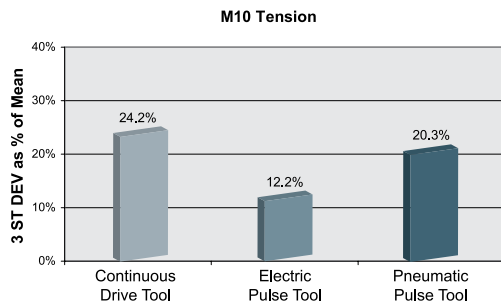

# Torque Measurement: Overview



Torque Measurement Systems										
Devices	Model Series	Data Collector	Integrated Transducer	Torque Wrench	Torque Wrench Loader	External Transducer Port	Stationary Transducers -Smart	Stationary Transducers -Ind Std	Rotary Transducer -Smart	Rotary Transducer - Ind Std
Testers	ATC		X							
	AUET		X							
	AUET-DC	X	X							
	AUET/MTM		X			X				
	AUET/MTM-DC	X	X			X				
Analyzers	ATDA					X				
	ATDA-DC	X				X				
Test Stands	AHCTS*	X*	X*	X*			X*	X*	X*	X*
	AHCTS-K*	X*	X*	X*			X*	X*	X*	X*
	AHDS*	X*	X*	X*			X*	X*	X*	X*
	AIMTS*	X*	X*	X*			X*	X*	X*	X*
Wrenches	ADW			X						
	ADW-DC	X								
	APTW			X						
	ATW			X						
	ATWL				X					
Torque Cart	iTVC*	X*	X*	X*			X*	X*	X*	X*
Transducers	ARTIS									X
	ASTIS							X		
	AISI						X			
	AISF						X			
Rundown Fixtures	AJKR									
	AJKS									
	ARDFA									
	ARDIA									
Joint Simulator	UFT									

\*configured to customer specifications

# Torque Measurement: Overview

## Torque Measurement: Testers

### Features and Benefits

- Heavy industrial design
- All software included
- Auditor Torque Testers are designed for intuitive and functional usability. AUET/MTM models are available with our unique dual integrated torque transducer package.

Testers are designed to audit torque wrenches and power tools, including pulse tools



	ATC	AUET	AUET/MTM	AUET-DC	AUET/MTM-DC
Auditor Torque Cube		Auditor Universal Electronic Tester	Auditor Universal Electronic Tester - Multiple Transducer Module	Auditor Universal Electronic Tester - Data Collector	Auditor Universal Electronic Tester/Multiple transducer Module - Data Collector
Compact vertical or horizontal bench-mount tester.		Bench mount or line side tester utilizing integrated transducer.	Bench mount or line side tester with dual integrated transducer and external transducer capacity.	Bench mount or line side tester utilizing integrated transducer. Provides data collection capability with included software to interface with PC.	Bench mount or line side tester with dual integrated transducer and external transducer capacity. Data collection capability with included software to interface with PC.
Integrated Transducer Range (values are in full scale)	1 - 1,350 Nm 100 in-oz - 1,000 ft-lb	1 - 1,000 Nm 100 in-oz - 750 ft-lb	1 - 1,000 Nm 100 in-oz - 750 ft-lb	1 - 1,000 Nm 100 in-oz - 750 ft-lb	1 - 1,000 Nm 100 in-oz - 750 ft-lb
External Transducer Capacity (Transducer sizes exceeding this range may be special ordered)			up to 5,000 ft-lb		up to 5,000 ft-lb
Vertical / Horizontal Mount	X				
Bi-directional accuracy of +/- X of indicated reading within the top 90% of the tester's capacity	1%	0.50%	0.50%	0.50%	0.50%
Data Output to PC	X	X	X	X	X
Integrated Torque Transducer	1	1	2	1	2
External Transducer Port			X		X
Number of Stored Readings	999	999	999	999	999
Adjustable Rundown Fixture Included *	1	1	2	1	2
Rechargeable NiMH Battery	X	X	X	X	X
<b>Measurement Modes</b>					
Peak	X	X	X	X	X
First Peak (Click)	X	X	X	X	X
Pulse	X	X	X	X	X
Track	X	X	X	X	X
Units of Measure Options	8	8	8	8	8
Tool Manager Software Included				X	X

\* Included with all testers and analyzers with a range up to 1000 in-lb.

## Torque Measurement Testers Used In Conjunction With

### External Transducers

ASTIS - Stationary			X		X
AISI / AISF - Stationary - Analog			X		X
ARTIS - Rotary			X		X

### Switch box for External Transducer

AISWT-4L > 4 Way Intellect box			X		X
AISWT-6L > 6 Way Intellect box			X		X

### Cables

ICBL-USB - USB Serial > PC	X	X	X	X	X
ATDBLIS - IS Transducer w/angle (10 Pin)			X		X
ATDBRIS - IS Transducer (4 Pin)			X		X
ICBL-10P - Intellect transducer cable Identification chip in cable - 10 pin connector			X		X
ICBL-4P - Intellect transducer cable. Identification chip in cable - 4 pin connector			X		X
ICBL-5000L - Connect from AUET/MTM & ATDA to Intellect Transducers, Analog AISI / AISF			X		X



# Auditor Torque Cube



**AUDITOR**™

## AUDITOR TORQUE CUBE

The Auditor Torque Cube (ATC) is a compact, versatile desktop tester that provides a multitude of capabilities. The ATC is designed to test hand or power tools with the following:

- Peak, first peak, and track modes
- Multiple engineering units
- Manual and auto clear function
- Multiple frequency response settings
- Bi-directional use and accuracy
- Accuracy is better than 1% of indicated reading top 90% of range
- Serial data output
- Memory: 999 data samples
- Battery and/or mains powered

Because precision and quality are critical, you can depend on Auditor testers to calibrate and certify your tools. Whether you are assembling large complicated systems or small precise time pieces, AIMCO provides the best system for your application. Our instruments have been judged "best in class" by independent National Standards laboratories. Auditor Torque Cube is rugged enough to test and verify tools at "point of use" while still being accurate enough to calibrate hand and power tools.

Each tester is shipped with a mains/battery charger power cord, a hex to allen drive bit, and a bolting template. Models with max torque of 1,000 in-lb or less also include a joint rundown fixture. The ATC can be positioned vertically or horizontally for the ergonomic testing of inline or pistol grip tools.

## ATC Auditor Torque Cube Models

Model	Recommended Torque Range		KG	Weight		W x H x D		Square Drive IN
	NM	IN-LB/FT-LB		LB	MM	IN		
<b>Vertical Configuration</b>								
ATC-10	0.13 - 1.13	1 - 10 in-lb	1.13	2.5	79 x 95 x 83	3.13 x 3.75 x 3.25	1/4	
ATC-25	0.28 - 2.83	2.5 - 25 in-lb	1.13	2.5	79 x 95 x 83	3.13 x 3.75 x 3.25	1/4	
ATC-100	1.13 - 11.3	10 - 100 in-lb	1.13	2.5	79 x 95 x 83	3.13 x 3.75 x 3.25	1/4	
ATC-250	2.83 - 28.3	25 - 250 in-lb	1.13	2.5	79 x 95 x 83	3.13 x 3.75 x 3.25	3/8	
ATC-500	5.65 - 56.5	50 - 500 in-lb	1.13	2.5	79 x 95 x 83	3.13 x 3.75 x 3.25	3/8	
ATC-750	8.47 - 84.8	75 - 750 in-lb	1.13	2.5	79 x 95 x 83	3.13 x 3.75 x 3.25	3/8	
ATC-1000	11.3 - 113	100 - 1000 in-lb	1.13	2.5	79 x 95 x 83	3.13 x 3.75 x 3.25	3/8	
ATC-1800	21.2 - 203	188 - 1,800 in-lb	1.13	2.5	79 x 95 x 83	3.13 x 3.75 x 3.25	1/2	
<b>Horizontal Configuration</b>								
ATC-150F	20 - 200	15 - 150 ft-lb	2.25	5	79 x 95 x 83	3.13 x 3.75 x 3.25	1/2	
ATC-250F	34 - 340	25 - 250 ft-lb	2.25	5	79 x 95 x 83	3.13 x 3.75 x 3.25	1/2	
ATC-500F	68 - 678	50 - 500 ft-lb	2.25	5	79 x 95 x 83	3.13 x 3.75 x 3.25	3/4	
ATC-750F	102 - 1,017	75 - 750 ft-lb	2.25	5	79 x 95 x 83	3.13 x 3.75 x 3.25	3/4	

# Auditor Bench-Mount Testers



AUET



AUET/MTM



AUET/MTM-DC

## AUDITOR UNIVERSAL ELECTRONIC TESTERS

Auditor Universal Electronic Testers (AUET) have a broad range of features to accommodate most requirements. They are designed to be bench-top mounted and are available in several configurations and various single or multiple torque ranges. Onboard memory allows you to capture 999 torque event readings. The testers are also available in file capability (DC) models that require PC software Auditor Tool Manager (ATM).

Instruments up to 1,000 in-lb are supplied with rundown adapters/joint kits. Rundown kits for larger instruments can be ordered separately. AUET/MTM units are supplied with an external transducer port and selector switch for connecting additional transducers.

AUET testers utilize the same transducers as the ATC instruments, providing the same high quality accuracy and durability. The common interface makes the Auditor tester extremely user friendly.



### AUET Single Transducer Models

Model*	Recommended Torque Range	
	KGF-CM/NM	IN-OZ/IN-LB
AUET-050(-DC)	0.4 - 3.6 kgf-cm	5 - 50 in-oz
AUET-0100(-DC)	0.7 - 7.2 kgf-cm	10 - 100 in-oz
AUET-10(-DC)	1.1 - 11.5 kgf-cm	1 - 10 in-lb
AUET-50(-DC)	0.5 - 5.6 Nm	5 - 50 in-lb
AUET-100(-DC)	1.1 - 11.3 Nm	10 - 100 in-lb
AUET-250(-DC)	2.8 - 28.3 Nm	25 - 250 in-lb
AUET-500(-DC)	5.7 - 56.5 Nm	50 - 500 in-lb
AUET-1000(-DC)	11.3 - 113 Nm	100 - 1,000 in-lb
AUET-1200(-DC)	13.6 - 135.6 Nm	120 - 1,200 in-lb
AUET-1800(-DC)	20.3 - 203.4 Nm	180 - 1,800 in-lb

\* Add "-DC" to part numbers for data collecting models.

Data collecting models allow multiple files/tools/applications to be associated with torque data. Requires Tool Manager software.

Custom sizes are also available. Contact an AIMCO Customer Service Associate for ordering options, 1-503-254-6600, or toll free 1-800-852-1368.

### AUET/MTM Dual Transducer Models

Model**	Recommended Torque Range			
	Transducer 1	Transducer 2	Transducer 1	Transducer 2
AUET/MTM-050-25	0.04 - 0.4 Nm	0.3 - 2.8 Nm	5 - 50 in-oz	2.5 - 25 in-lb
AUET/MTM-050-600	0.04 - 0.4 Nm	6.8 - 67.8 Nm	5 - 50 in-oz	60 - 600 in-lb
AUET/MTM-0100-050	0.07 - 0.71 Nm	0.04 - 0.4 Nm	10 - 100 in-oz	5 - 50 in-oz
AUET/MTM-10-100	0.11 - 1.12 Nm	1.3 - 11.3 Nm	1.0 - 10 in-lb	10 - 100 in-lb
AUET/MTM-50-250	0.56 - 5.65 Nm	2.8 - 28.3 Nm	5.0 - 50 in-lb	25 - 250 in-lb
AUET/MTM-50-500(-DC)	0.56 - 5.65 Nm	5.7 - 56.5 Nm	5.0 - 50 in-lb	50 - 500 in-lb
AUET/MTM-50-1000(-DC)	0.56 - 5.65 Nm	11.3 - 113 Nm	5.0 - 50 in-lb	100 - 1,000 in-lb
AUET/MTM-100-500	1.13 - 11.3 Nm	5.7 - 56.5 Nm	10 - 100 in-lb	50 - 500 in-lb
AUET/MTM-100-1000	1.13 - 11.3 Nm	11.3 - 113 Nm	10 - 100 in-lb	100 - 1,000 in-lb
AUET/MTM-100-1200	1.13 - 11.3 Nm	13.6 - 135.6 Nm	10 - 100 in-lb	120 - 1,200 in-lb
AUET/MTM-100-1600(-DC)	1.13 - 11.3 Nm	18.1 - 180.8 Nm	10 - 100 in-lb	160 - 1,600 in-lb
AUET/MTM-100-2000	1.13 - 11.3 Nm	22.6 - 226 Nm	10 - 100 in-lb	200 - 2,000 in-lb
AUET/MTM-250-1600	2.82 - 28.2 Nm	18.1 - 180.8 Nm	25 - 250 in-lb	160 - 1,600 in-lb
AUET/MTM-250-1800	2.82 - 28.2 Nm	20.3 - 203.4 Nm	25 - 250 in-lb	180 - 1,800 in-lb
AUET/MTM-250-2500	2.82 - 28.2 Nm	28.2 - 282.5 Nm	25 - 250 in-lb	250 - 2,500 in-lb
AUET/MTM-500-1200	5.7 - 56.5 Nm	13.6 - 135.6 Nm	50 - 500 in-lb	120 - 1,200 in-lb
AUET/MTM-500-2500(-DC)	5.7 - 56.5 Nm	28.2 - 282.5 Nm	50 - 500 in-lb	250 - 2,500 in-lb

Custom sizes are also available. Contact an AIMCO Customer Service Associate for ordering options, 1-503-254-6600, or toll free 1-800-852-1368.

# Auditor Torque Measurement Analyzers

## Torque Measurement: Analyzers

### Features and Benefits

- Auditor Torque Analyzers share similar features across all products and are designed for intuitive and functional usability.
- Connects to AIMCO's line of rotary and stationary transducers



	ATDA	ATDA-DC
Auditor Torque Data Analyzer		Auditor Torque Data Analyzer with Data Collection
Portable analyzer to be connected to various transducers		Portable analyzer to be connected to various transducers. Provides data collection capability with included software to interface with PC
Bi-directional	X	X
Data Output to PC	X	X
External Transducer Port	1	1
Number of stored readings	999	999
Rechargeable NiMH Battery	X	X
Digital I/O for external devices	X	X
Measurement Modes	X	X
Peak	X	X
First Peak (Click)	X	X
Pulse	X	X
Track	X	X
Measurement Units	8	8
Software Included		X

### Used In Conjunction With

#### Transducers

AISI / AISF - Analog	X	X
AISI / AISF - Digital		
ASTIS - Stationary	X	X
ARTIS - Rotary	X	X

#### Wrenches

ATW	X	X
-----	---	---

#### Switch boxes for External Transducers

AISWT-4L > 4 Way Intellect box	X	X
AISWT-6L > 6 Way Intellect box	X	X

#### Cables

ICBL-USB - USB Serial > PC	X	X
ATDBLIS - IS Transducer w/ angle (10 Pin)	X	X
ATDBRIS - IS Transducer (4 Pin)	X	X
ICBL-10P - Intellect transducer cable. Identification chip in cable - 10 pin connector	X	X
ICBL-4P - Intellect transducer cable. Identification chip in cable - 4 pin connector	X	X
ICBL-5000L - Connect from AUET/MTM & ATDA to Intellect Transducer, Analog AISI / AISF	X	X

# Auditor Torque Data Analyzers



ATDA-DC

## AUDITOR TORQUE DATA ANALYZERS

The Auditor Torque Data Analyzer (ATDA) DC is designed to be portable or conveniently placed on a bench. The tester can be connected to various transducers, as well as transducerized wrenches and rotary or stationary transducers. The user interface is common between the ATC (Cube), AUET, AUET-DC, AUET/MTM, AUET/MTM-DC, ATDA, and ATDA-DC. All of these instruments have similar menus. Additionally, all data collector testers utilize Auditor Tool Manager for tool testing and data management.

The Auditor Torque Data Analyzer is available in two configurations:

- ATDA: A simple torque analyzer with sequential memory, 999 data samples, engineering limits, limited statistical processing average, range, Cp and CpK with serial output
- ATDA-DC: Contains all of the features of the ATDA and has additional file capability. It can associate data with file names and manage data collection with a computer and Auditor Tool Manager software



This is a great “starter” tool management system. It provides testing, archiving, and analysis of tools at single or multiple torque targets. The tool and torque data is stored in a SQL database and can be exported to Excel or any .csv spreadsheet.

### ATDA Auditor Torque Data Analyzer Models

MODEL	DESCRIPTION
ATDA	Auditor Torque Data Analyzer
ATDA-DC	Auditor Torque Data Collector

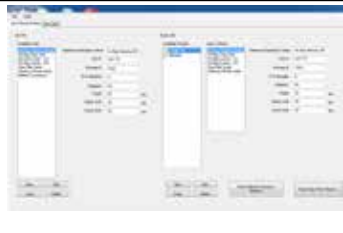

# Auditor Data Collection Software

Data Collection Software		
		
<b>Auditor Tool Manager Software</b>	<b>Auditor Audit Manager Software</b>	<b>SMD Tools Software</b>
Test, verify, and archive tools	Comprehensive statistical analysis, data archiving, and data export	Use a PC as a torque tester/display for testers and transducers
Create a database of tools and store test results with easy-to-use software integrator to/from tester to PC	Facilitate residual auditing with digital wrenches and transducerized wrenches	Comprehensive, pre-configured, and guided testing of specific tools as well as manual testing with all testing parameters adjustable and set by the user

Compatibility		
Desktop or PC		X
ATC		X
ADW	X	
ATDA		X
ATDA-DC	X	X
AUET		X
AUET-DC	X	X
AUET/MTM		X
AUET/MTM-DC	X	X
ARTIS		
ARTIS-DIG		X
AISI/AISF		
AISI/AISF (Digital)		X
iTVC Torque Cart		X

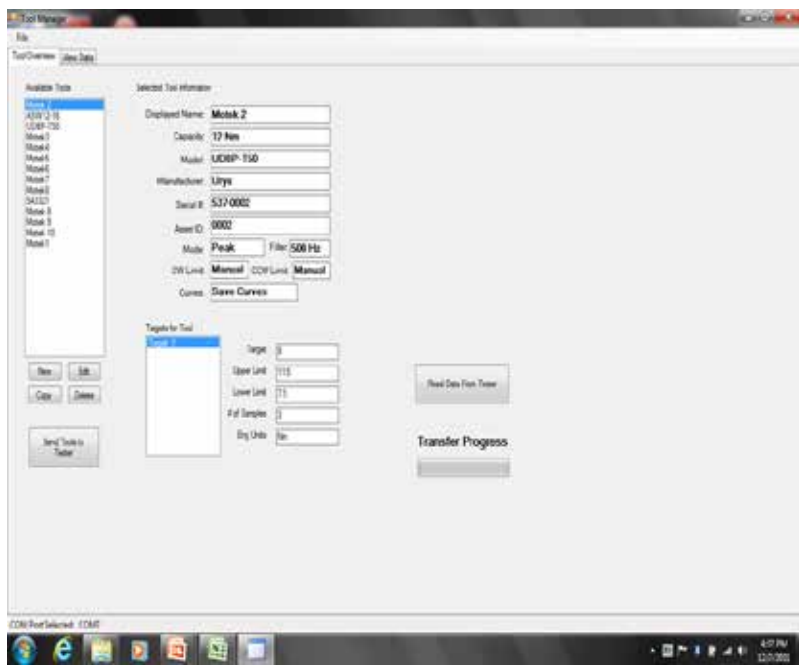

## AUDITOR TOOL MANAGER SOFTWARE

Tool Manager Software is included with the purchase of AUET-DC and AUET/MTM-DC data-collecting torque testers, as well as the ADW-DC data-collecting torque wrench. Create a database of tools and store test results with this easy-to-use software integrator to/from tester to PC.

Tool Manager Software, Tool Overview Screen

# Auditor Data Collection Software

## AUDITOR AUDIT MANAGER SOFTWARE

Audit Manager Software is included with the purchase of ATDA-DC data collecting torque analyzers. The View Data tab allows you to look at the collected data and the trace file. This data can be exported to Excel as a .csv file and displayed by Excel charts. The trace file displays the data in a torque/time graph and allows the user to supersede the move-on reading selected by the wrench by visually discerning via the trace where the fastener started to rotate. When selecting a single job the average, range, sigma, Cp, and CpK values are listed.

Audit Manager Software,  
Job and Route Builder Screen

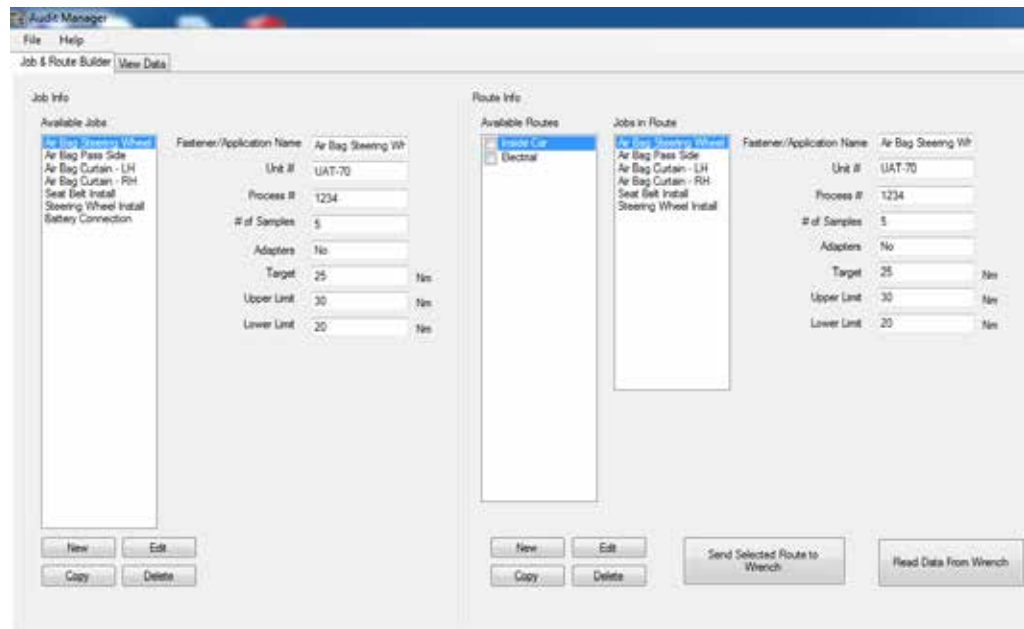

## SMD TOOLS SOFTWARE

A digital signal between a PC and a digital transducer allows SMD Tools software to operate independently of a tester or analyzer to collect and store data in Microsoft Excel.

Tool Manager and Test Manager databases within the software stores tool details and test processes for easy access in the Cert Manager platform



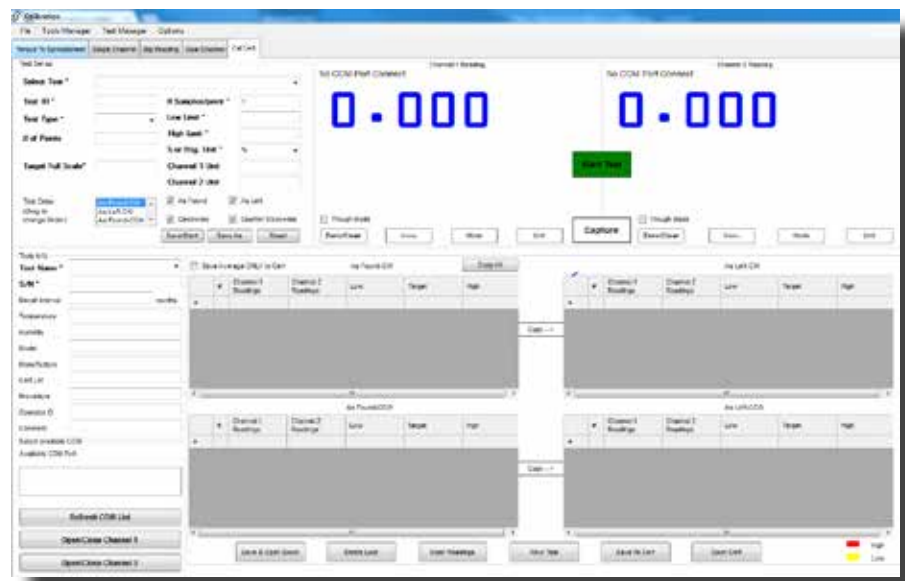

Auditor branded analyzers and testers can network with this software to produce and store real-time data



SMD Tools Software, Cal Cert Screen

# Auditor High-Capacity Test Stands



## Torque Measurement: High Capacity Test Stands

<b>Features and Benefits</b> <ul style="list-style-type: none"> <li>Advanced test stations for larger tools and higher torque output</li> <li>Configured to meet application requirements</li> <li>Durable industrial grade devices</li> </ul>				
	<b>AHCTS</b>	<b>AHCTS-K</b>	<b>AHDTS</b>	<b>AIMTS</b>
	Auditor High Capacity Test Stand	Auditor High Capacity Test Stand - Hydraulic	Auditor High Capacity Test Stand Dual Transducer	Auditor High Capacity Impact Test Stand
	Designed for testing tools with continuous rotating output spindles and pulse tools.	Specifically designed for hydraulic wrenches testing.	Two transducers, one for rotary tools and one for hydraulic tools. Includes rundown & reaction fixtures with a single display.	Ideal for testing impact wrenches and is recommended to utilize rundown fixtures when testing impacts.
<b>Capacity</b>	6,750 Nm	33,750 Nm	33,750 Nm	2,700 Nm

## Accessories

<b>Rundown fixtures</b>				
AHCTS-3/4RDF	X		X	
AHCTS-1RDF	X		X	
AHCTS-1.5RDF	X		X	

## Adapters

		AHCTS	AHCTS-K	AHDTS	AIMTS
<b>Square to Square Drive Adapters*</b>					
	CA1510 1-1/2" Male to 1" Female	X		X	
	CA1550 1-1/2" Male to 1/2" Female	X		X	
	CA1575 1-1/2" Male to 3/4" Female	X		X	
<b>Insert Adapters*</b>					
	CA2510I 2-1/2" Male to 1" Female	X	X	X	
	CA2515I 2-1/2" Male to 1-1/2" Female	X	X	X	
	CA2575I 2-1/2" Male to 3/4" Female	X	X	X	
<b>Square to Hex Drive Adapters*</b>					
	CA150108DHD 1-1/2" Male to 1-1/2" Male Hex		X		

\* Partial List. Contact An Aimco Customer Service Associate For More Options, 1-503-254-6600, Or Toll Free 1-800-852-1368.

# Auditor High-Capacity Test Stands



AHCTS-5000

## AHCTS TEST STAND FOR ROTATING TOOLS

Designed for testing tools with continuous rotating output spindles. The test stand includes a rundown fixture, bushing for side load support, reaction post or reaction paddles, transducer and torque analyzer display.

### AHCTS Test Stand Models

Model	Description
AHCTS-0500	3/4" Square Drive w/rundown fixture
AHCTS-2500	1.5" Square Drive w/rundown fixture
AHCTS-5000	1.5" Square Drive w/rundown fixture
AHCTS-7500	1.5" Square Drive w/rundown fixture

Please refer to Configuration Options on the following page for required ordering options.



AHCTS-001K

## AHCTS-K STAND FOR HYDRAULIC TOOLS

The AHCTS-K stands are specifically designed for hydraulic wrench testing. Hydraulic wrenches have very low profiles but very high torque output, therefore, working height must be minimized to prevent side loading which could lead to errors in data or damage to tool or reaction devices.

Either stand can be ordered with options such as extension legs, casters, embedded or attached torque analyzers with various rundown fixtures and reaction devices. Contact an AIMCO Customer Service Associate for additional information, 1-503-254-6600, or toll free 1-800-852-1368.

### AHCTS-K Test Stand Models

Model	Description	Capacity Ft-Lb
AHCTS-0.5K	3/4" Square Drive w/reaction device	500
AHCTS-001K	1" Square Drive w/reaction device	1,000
AHCTS-2.5K	1.5" Square Drive w/reaction device	2,500
AHCTS-005K	1.5" Square Drive w/reaction device	5,000
AHCTS-010K	1.5" Square Drive w/reaction device	10,000
AHCTS-025K	2" Square Drive w/reaction device	25,000

Please refer to Configuration Options on following page for required ordering options.

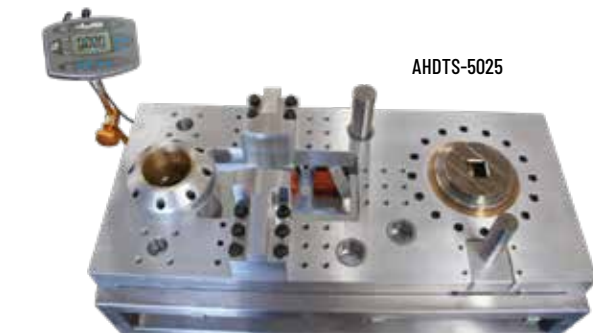

AHDTs-5025

## AHDTs DUAL TEST STAND FOR ROTATING AND HYDRAULIC TOOLS

This stand has two transducers embedded into the base, one for rotary tools and one for hydraulic tools. It comes with rundown and reaction fixtures and one display.

### AHDTs Dual Test Stand Models

Model	Description
AHDTs-5025	1.5" Sq Dr dual station w/rundown fixture and reaction devices

Contact an AIMCO Customer Service Associate for ordering options, 1-503-254-6600, or toll free 1-800-852-1368.

Optional Pelican Case shown (ordered separately)



25503



# Auditor High-Capacity Test Stands

## AHCTS Series High Capacity Test Stands for Rotary and Hydraulic Tools Configuration Options

Base Model Number	Display	Legs	Base Size	Run-down Fixture Capacity (ft-lb)	Reaction Post	Casters	Articulated Arm and Mount	Digital Module
AHCTS-xxxx	1 = ATDA 2 = No Embedded Display 3 = ATDA-DC 6 = Standard Embedded Display  (1, 3, 4, 5 include articulated arm)	1 = 6" 2 = No legs (Standard) 3 = 18" 4 = Custom	0 = 8 x 8" 1 = 12 x 12" 3 = 14 x 19" (Standard) 4 = 18 x 24" 5 = 18 x 36" 6 = NA	1 = 500 2 = No 3 = 1,000 4 = 2,500 5 = 5,000 6 = 7,500 7 = 1.5" Kit Max. capacity 7,500 Ft-Lb 8 = 2.5" Kit Max. capacity 7,500 Ft-Lb	1 = Single 6" Post and Paddles 2 = No 3 = Multiple Posts 6" 4 = Paddles 5 = Custom 6 = Single 9" Post and Paddles 7 = Multiple Posts 9"	1 = Yes 2 = No	1 = Yes 2 = No	1 = Yes (for Tablet or PC direct) 2 = No
Model Number Digits 1-10	Model # Digit 11	Model # Digit 12	Model # Digit 13	Model # Digit 14	Model # Digit 15	Model # Digit 16	Model # Digit 17	Model # Digit 18

### Auditor High Capacity Test Stand for Rotary Tools

AHCTS-0500 680 Nm / 500 ft-lb			0, 1, or 3					
AHCTS-1000 1,360 Nm / 1,000 ft-lb			0, 1, or 3					
AHCTS-2500 3,400 Nm / 2,500 ft-lb			0, 1, or 3					
AHCTS-5000 6,800 Nm / 5,000 ft-lb			0, 1, or 3					
AHCTS-7500 10,200 Nm / 7,500 ft-lb			0, 1, or 3					

### Auditor High Capacity Test Stand for Hydraulic Tools

AHCTS-0.5K 680 Nm / 500 ft-lb			0-5 (3-5 come with casters)	2				
AHCTS-001K 1,360 Nm / 1,000 ft-lb			0-5 (3-5 come with casters)	2				
AHCTS-2.5K 3,390 Nm / 2,500 ft-lb			0-5 (3-5 come with casters)	2				
AHCTS-005K 6,800 Nm / 5,000 ft-lb			0-5 (3-5 come with casters)	2				
AHCTS-010K 13,600 Nm / 10,000 ft-lb			0-5 (3-5 come with casters)	2				
AHCTS-025K 34,000 Nm / 25,000 ft-lb			0-5 (3-5 come with casters)	2				
AHCTS-050K 68,000 Nm / 50,000 ft-lb			0-5 (3-5 come with casters)	2				

# Auditor High-Capacity Test Stands

## AIMTS TEST STAND FOR IMPACT TOOLS

Obtain accurate test results with the AIMTS Series Impact Test Stand. When used with an Auditor ATDA Analyzer or AUET/MTM Desktop Torque Tester, the tool's performance data can be recorded and stored. Each Auditor Analyzer comes standard with PC-based software to store and organize data for use within a quality system. It is necessary to bolt the AIMTS to a bench. We also recommend that a rundown fixture always be used for testing impacts.



**AIMTS-0500**  
Test stand for small impact tools



**AIMTS-2000**  
Test stand for large impact tools

### AIMTS Test Stand Models

Model	Description
AIMTS-0500	¾" square drive impact test stand
AIMTS-2000	1.5" square drive impact test stand





Refer to Configuration Options below for required ordering options.

### AIMTS Series High Capacity Impact Test Stand Configuration Options

Base Model #	Display	Legs	Base Size	Rundown Fixture Capacity (ft-lb)*		Options	Digital Module
AIMTS-xxxx	1 = ATDA 2 = No Embedded Display 3 = ATDA-DC	1 = 6" 2 = No legs (Standard) 3 = 18" 4 = Custom	6 = Bench Stand	1 = 500 2 = No 3 = 2,000 4 = 50 5 = 5,000	6 = 10,000 7 = 20,000 8 = 250 9 = 2,500	Not available for AIMTS test stands. Enter 222 for model # digits 15-17	1 = Yes (for Tablet or PC direct) 2 = No
Model Number Digits 1-10	Model Number Digit 11	Model Number Digit 12	Model Number Digit 13	Model Number Digit 14		Model Number Digits 15-17	Model Number Digit 18
AIMTS-0050 68 Nm / 50 ft-lb		2	6			222	
AIMTS-0250 340 Nm / 250 ft-lb		2	6			222	
AIMTS-0500 680 Nm / 500 ft-lb		2	6			222	
AIMTS-2000 2,720 Nm / 2,000 ft-lb		2	6			222	
AIMTS-2500 3,390 Nm / 2,500 ft-lb		2	6			222	
AIMTS-5000 6,780 Nm / 5,000 ft-lb		2	6			222	

\* Ordering more than one rundown fixture is highly recommended if you're doing a lot of testing. Having multiple rundown fixtures ensures that you have spares when dealing with heat issues. AIMTS test stands are available in capacities of up to 20,000 ft-lb. Capacities other than what is shown here are quoted separately. Contact an AIMCO Customer Service Associate at 1-503-254-6600, or toll free 1-800-852-1368.

# Auditor Torque Wrenches

Torque Measurement: Torque Wrench				
<b>Features and Benefits</b> <ul style="list-style-type: none"> <li>• Multiple Options from Simple to Sophisticated</li> <li>• Similar Interface with other Auditor Products</li> <li>• Durable</li> </ul>				
	<b>ADW</b>	<b>ADW-DC</b>	<b>APTW</b>	<b>ATW</b>
	Auditor Digital Wrench	Auditor Digital Wrench with Data Collection	Auditor Preset Torque Wrench	Auditor Torque Wrench
<b>Torque Range</b>	10 – 500 Nm 7 – 370 ft-lb	10 – 500 Nm 7 – 370 ft-lb	5 – 340 Nm 4 – 250 ft-lb	5 – 200 Nm 4 – 148 ft-lb
	Digital wrench with multiple head options for line side testing/auditing	Data-collecting digital wrench with multiple head options for line side testing/auditing	Interchangeable heads. Preset uses proprietary adjustment tool to guard against unauthorized setting changes	Transducer on a stick. Communicates with data collecting testers and analyzers
<b>Bi-Directional accuracy of +/- X of indicated reading within the top 90% of the tester's capacity</b>	1%	1%	3%	0.50%
<b>Software Included</b>	X	X		

Used In Conjunction With				
ATDA (DC) Data Analyzer				X
AUET (DC) Tester				X
AUET/MTM (DC) Tester				X

## Torque Wrench Loaders



For calibration of all types of torque wrenches, eliminating human variables for more accurate measurement.

ATWL-250	Torque range up to 340 Nm / 250 ft-lb
ATWL-750	Torque range up to 1,020 Nm / 750 ft-lb
ATWL-1000	Torque range up to 1,360 Nm / 1,000 ft-lb

# Auditor Digital Wrench Series



ADW-0010K111312222



ADW-1400F125312222

## ADW DATA COLLECTING TORQUE WRENCH

- Large memory capacity
- Every torque value has associated trace file
- "Pick a Point" and "Move On" feature
- Barcode scanner
- Alpha Numeric screen for entering text
- Field replaceable batteries
- Docking station connection
- Serial connection
- Battery charger connection
- Ergonomic handle
- Switch between measure and data collection modes at any time
- Multiple files and route capability
- Data memory and simple statistics "On Board"
- Complete statistical analysis, data archiving and exporting in Audit Manager software
- Five models standard ranges 10 - 500 Nm full scale
- Torsion transducer – not length dependent
- Transducer is replaceable
- 1,400 Nm model uses different handle design

## ADW Torque Wrench Models

Model	Torque Range		Weight		Overall Length		Sq. Drive IN
	NM	FT-LB	LB	KG	IN	MM	
ADW-0010K	1 - 10	0.7 - 7.4	2.2	1	18	457.2	1/4
ADW-0075K	7.5 - 75	5.5 - 55	3.1	1.4	23.5	596.9	3/8
ADW-0180K	18 - 180	13 - 130	3.6	1.6	30.1	765.2	1/2
ADW-0270K	27 - 270	20 - 198	3.6	1.6	30.1	765.2	3/4
ADW-0500K	50 - 500	37 - 369	4	1.8	36	914	1
ADW-1400F	140 - 1,400	103 - 1,033	4.8	2.2	60	1,524	1

Unit accuracy is  $\pm 1.0\%$  FSD of indicated reading for the top 95% of full scale as indicated above.

Each model includes a case, a battery charger, and a standard square-drive head. Other heads are available at additional cost.

\*Part numbers with K, D or F followed by a 1 designate models with file and route capability. K followed by 2 indicate sequential memory but no file capability.

Part numbers with K, D or F followed by a 1,1 indicate file and route with bar code and docking station capability. K, D or F followed by a 1,2 indicate file and route capability with serial port only.

Please refer to the Configuration Options table on following page for required ordering options.

# Auditor Digital Wrench Series

## ADW Series Digital Torque Wrenches Configuration Options

Base Model Number	Style	Data Collector	Bar Code and Docking Station	Square Drive Size	Type of Transducer	Engineering Unit	Future Options
ADW-xxxx	K = Katana D = Katana with Dovetail Transducer F = Straight Stick	1 = Yes 2 = No	1 = Yes 2 = No (Serial Port Only)	1 = 1/4" 2 = 3/8" 3 = 1/2" 4 = 3/4" 5 = 1" 6 = N/A	1 = Intellect 2 = Industrial Standard 3 = N/A	1 = Nm 2 = Ft-lb 3 = In-lb	Not yet available.  Enter 2222 for model # digits 15-18
Model # Digits 1-8	Model # Digit 9	Model # Digit 10	Model # Digit 11	Model # Digit 12	Model # Digit 13	Model # Digit 14	Model # Digits 15-18

### Non Data-Collecting (Sequential Memory)

ADW-0010K2 10 Nm / 7.4 ft-lb	K or D	2	2	1 or 2	3	1	2222
ADW-0075K2 75 Nm / 55 ft-lb	K or D	2	2	2	3	1	2222
ADW-0180K2 180 Nm / 130 ft-lb	K or D	2	2	3	3	1	2222
ADW-0270K2 270 Nm / 198 ft-lb	K or D	2	2	3	3	1	2222
ADW-0500K2 500 Nm / 369 ft-lb	K or D	2	2	4	3	1	2222
ADW-1000K2 1,000 Nm / 738 ft-lb	F	2	2	4 or 5	3	1	2222
ADW-1200K2 1,200 Nm / 885 ft-lb	F	2	2	5	3	1	2222
ADW-1000K2 1,400 Nm / 1,033 ft-lb	F	2	2	5	3	1	2222
ADW-1200K2 2,000 Nm / 1,475 ft-lb	F	2	2	5	3	1	2222

### Data Collecting (File and Route Capability)

ADW-0010K1 10 Nm / 7.4 ft-lb		1		1 or 2	3	1	2222
ADW-0075K1 75 Nm / 55 ft-lb		1		2	3	1	2222
ADW-0180K1 180 Nm / 130 ft-lb		1		3	3	1	2222
ADW-0270K1 270 Nm / 198 ft-lb		1		3	3	1	2222
ADW-0500K1 500 Nm / 369 ft-lb		1		4	3	1	2222
ADW-1000K2 1,000 Nm / 738 ft-lb	F			4 or 5	3	1	2222
ADW-1200K2 1,200 Nm / 885 ft-lb	F			5	3	1	2222
ADW-1000K2 1,400 Nm / 1,033 ft-lb	F			5	3	1	2222
ADW-1200K2 2,000 Nm / 1,475 ft-lb	F			5	3	1	2222

Standard capacities shown. Additional capacities available on request. Contact an AIMCO Customer Service Associate at 1-503-254-6600, or toll free 1-800-852-1368.

# Auditor Electronic Torque Wrenches

ALLOW PRECISE TIGHTENING AND AUDITING OF YOUR ASSEMBLY APPLICATIONS

## “TRANSDUCERS ON A STICK”

- Non-Length Dependent - Where the operator’s hand is positioned during use has no effect on torque readings
- Available in Industry Standard (IS) or Intelligent (Intellect) Configurations - Transducer is compatible with a wide variety of IS style instruments or Auditor Intellect instruments that self recognize the transducer
- Durable - Steel, Aluminum and Carbon Fiber construction provide optimal strength and weight. Transducer supplied with overload capacity of 150% of full scale
- Accurate - Torque readings are accurate to 1% of indicated reading in top 95% of full scale



## ATW Torque Wrench Models

Model	Torque Range		Square Drive
	NM	FT-LB	IN
ATW-0100F	14 - 136	10 - 100	3/8
ATW-0200F	27 - 272	20 - 200	1/2
ATW-0500F	68 - 680	50 - 500	3/4
ATW-1000F	136 - 1,360	100 - 1,000	1

Required Accessory: ATDBRIS IS cable to connect Auditor ATDA instrument.



# Auditor Preset Torque Wrenches

Auditor's APTW preset wrenches provide a flexible, easy way to audit fastener torque. A wide range of interchangeable heads provide flexibility and convenience.

## FEATURES AND BENEFITS



- Easy-to-use preset wrenches for fastener torque auditing
- Torque ranges from 5 - 340 Nm
- User friendly, sleek, ergonomic design
- Tactile feedback on achievement of preset torque
- Proprietary adjustment tool guards against unauthorized setting changes
- Wide range of interchangeable heads provide flexibility and convenience
- +/- 3% accuracy when used in clockwise or counterclockwise directions







## APTW Torque Wrench Models



WRENCH MODEL	TORQUE RANGE	INSERT ACCEPTED
APTW-25	5 - 25 Nm	12 mm
APTW-50	10 - 50 Nm	12 mm
APTW-100	20 - 100 Nm	12 mm
APTW-150	30 - 150 Nm	12 mm
APTW-200	40 - 200 Nm	14 mm
APTW-340	60 - 340 Nm	14 mm



## TORQUE WRENCH INSERTS

Adapters	Description
 APTH-12ADP	9 x 12 M to 14 x 18 F
 APTH-14ADP	14 x 18 M to 9 x 12 F

Ring End Inserts	Description
 APTH-12RE50	1/2" Ring End, 12 mm
 APTH-14RE32	32 mm Ring End, 14 mm

Square Drive Inserts	Description	
	9 x 12	
	APTH-12SD25	1/4" Sq. Dr.
	APTH-12SD38	3/8" Sq. Dr.
	APTH-12SD50	1/2" Sq. Dr.
	14 x 18	APTH-14SD50

Blank End Inserts	Description
 APTH-12BLANK	12 mm
 APTH-14BLANK	14 mm

Ratchet Heads	Description	
	9 x 12	
	APTH-12RT25	1/4" Sq. Dr.
	APTH-12RT38	3/8" Sq. Dr.
	APTH-12RT50	1/2" Sq. Dr.
	14 x 18	APTH-14RT50
	APTH-14RT34	3/4" Sq. Dr.

Open End Head Inserts							
	9 x 12		14 x 18				
	Model	Description	Model	Description	Model	Description	
	APTH-120E7	7 mm OE	APTH-140E1	1" OE	APTH-140E25	25 mm OE	
	APTH-120E8	8 mm OE	APTH-140E13	13 mm OE	APTH-140E27	27 mm OE	
	APTH-120E9	9 mm OE	APTH-140E14	14 mm OE	APTH-140E30	30 mm OE	
	APTH-120E10	10 mm OE	APTH-140E15	15 mm OE	APTH-140E32	32 mm OE	
	APTH-120E11	11 mm OE	APTH-140E16	16 mm OE	APTH-140E34	34 mm OE	
	APTH-120E12	12 mm OE	APTH-140E17	17 mm OE	APTH-140E36	36 mm OE	
	APTH-120E13	13 mm OE	APTH-140E18	18 mm OE	APTH-140E38	38 mm OE	
	APTH-120E14	14 mm OE	APTH-140E19	19 mm OE	APTH-140E41	41 mm OE	
	APTH-120E15	15 mm OE	APTH-140E21	21 mm OE	APTH-140E118	1-1/8" OE	
	APTH-120E16	16 mm OE	APTH-140E22	22 mm OE	APTH-140E138	1-3/8" OE	
	APTH-120E17	17 mm OE	APTH-140E24	24 mm OE			
	APTH-120E18	18 mm OE					
	APTH-120E19	19 mm OE					
	APTH-120E20	20 mm OE					
	APTH-120E50	1/2" OE					

# iTVC Torque Cart



AIMCO's iTVC Torque Cart is designed for "lineside" or "point of use" tool validation and calibration. Our torque carts allow testing of tools on repeatable joint simulators and "in process" use on production joints, allowing users to identify process capability. Multiple torque cart configurations are available with simple to sophisticated options:

- Manual push carts equipped with simple torque testers
- Manual push carts equipped with data collectors and database application software
- Self propelled cart with computer and relational database application
- Driven cart with computer and relational database application



## FEATURES AND BENEFITS

- For testing on repeatable joint simulators or actual production joints
- Mobile test carts can be configured for testing continuous and discontinuous drive tools, including DC electric, clutch, battery, impulse, and torque wrenches
- Each cart is customizable to meet testing needs from 1 – 1,400 Nm
- Data management software options are available to suit specific audit or asset-tracking needs
- Torque wrench loaders are configurable to suit wrench populations

Carts can be equipped to specific customer requirements. Ancillary test stands up to 50,000 ft-lb available. Contact an AIMCO Customer Service Associate for a quote or for more details, 1-503-254-6600, or toll free 1-800-852-1368.



	Model	Description	Low Torque		High Torque			
			NM	FT-LB	NM	FT-LB		
UFT	<b>Mobile-Powered</b>							
	iTVC.A	Torque Cart, UFT Mobile Base #						
	iTVC.A2XXXXXX	NO JOINTS	0	0	0	0		
	iTVC.A2XBCXXX	2 UFTs	15	11	190	140		
	iTVC.A2XBCDXX	3 UFTs	15	11	686	506		
	iTVC.A2ABCDXX	4 UFTs	1	0.7	686	506		
	iTVC.A2ABCDEP	4 UFTs, 1 AJKR, Printer	1	0.7	1,400	1,033		
	<b>Manual</b>							
	iTVC.A1XXXXXX	Torque Cart, UFT Manual Base #						
	iTVC.A1XBCXXX	2 UFTs	15	11	190	140		
	iTVC.A1XBCDXX	3 UFTs	15	11	686	506		
	iTVC.A1ABCDXX	4 UFTs	1	0.7	686	506		
iTVC.A1ABCXEX	3 UFTs, 1 AJKR	1	0.7	1,400	1,033			
iTVC.A1ABCDEP	4 UFTs, 1 AJKR	1	0.7	1,400	1,033			
AJKR	<b>Mobile-Powered</b>							
	iTVC.B2XXXXX	Torque Cart, AJKR Mobile Base #						
	iTVC.B2XBCXX	2 joints	27	20	271	200		
	iTVC.B2XBCEX	3 joints	27	20	1,400	1,033		
	iTVC.B2ABCPEP	4 joints	6	4.4	1,400	1,033		
	<b>Manual</b>							
	iTVC.B1XXXXX	Torque Cart, AJKR Manual Base #						
	iTVC.B1XBCXX	2 joints	27	20	271	200		
iTVC.B1XBCEX	3 joints	27	20	1,400	1,033			
iTVC.B1ABCPEP	4 joints	6	4.4	1,400	1,033			
BASE	<b>Mobile-Powered</b>							
	iTVC.X2X	Cart, no computer	–	–	–	–		
	iTVC.X2A	Cart, w/computer	–	–	–	–		
	<b>Manual</b>							
iTVC.X1X	Cart, no Computer	–	–	–	–			
iTVC.X1A	Cart, w/Computer	–	–	–	–			





# Transducers

## Torque Measurement: Transducers

### Features and Benefits Superior:

- Accuracy
- Compatibility
- Durability

Auditor offers multiple styles of transducers in various configurations. Industry standard transducers (2mv/v) and intellect transducers for Auditor instruments that reduce configuration set up time.

	Rotary	Stationary	
			
	<b>ARTIS</b>	<b>ASTIS</b>	<b>AISI - AISF*</b>
	Auditor Rotary Transducer Industry Standard	Auditor Stationary Transducer Industry Standard	Auditor Industry Standard Stationary

### Used in Conjunction with Analyzer

AUET	X		
AUET/MTM	X	X	X
ATDA	X	X	X

\* See Configuration Options on following page to configure complete part number for AISI / AISF models. Please contact an AIMCO Customer Service Associate for additional information, 1-503-254-6600, or toll free 1-800-852-1368.

## AUDITOR ROTARY TRANSDUCCERS

Suitable for use with all continuous drive tools, impulse tools and torque wrenches.



ARTIS Series

Model	Drive IN	Max Torque		Weight LB
		NM	IN-LB/FT-LB	
ARTIS-25H-2T(A)	1/4 Hex	2	18 in-lb	1.0
ARTIS-25H-5T(A)	1/4 Hex	5	44 in-lb	1.0
ARTIS-25H-10T(A)	1/4 Hex	10	88 in-lb	1.0
ARTIS-25H-20T(A)	1/4 Hex	20	180 in-lb	1.0
ARTIS-25S-10T(A)	1/4 Sq.	10	88 in-lb	1.0
ARTIS-25S-20T(A)	1/4 Sq.	20	180 in-lb	1.0
ARTIS-38S-25T(A)	3/8 Sq.	25	225 in-lb	1.2
ARTIS-38S-75T(A)	3/8 Sq.	75	50 ft-lb	1.2
ARTIS-50S-180T(A)	1/2 Sq.	180	130 ft-lb	1.5
ARTIS-75S-250T(A)	3/4 Sq.	250	180 ft-lb	2.2
ARTIS-75S-500T(A)	3/4 Sq.	500	370 ft-lb	2.2
ARTIS-100S-750T(A)	1 Sq.	750	553 ft-lb	4.0
ARTIS-100S-1400T(A)	1 Sq.	1400	1,025 ft-lb	4.0

\*Add "A" to the end of the part number to indicate torque/angle transducer.

# AUDITOR™

# Transducers

## AUDITOR STATIONARY TRANSDUCERS

Stationary Transducers with joint rundown fixtures and, where applicable, bench stands.



ASTIS

ASTIS industry standard transducers can be used with multiple analyzers.

### ASTIS Transducers

Model	Max Torque		Drive IN
	NM	IN-LB/FT-LB	
ASTIS-25D-11	11	100 in-lb	1/4
ASTIS-25D-28	28	250 in-lb	1/4
ASTIS-38D-135	135	100 ft-lb	3/8
ASTIS-50D-270	270	200 ft-lb	1/2
ASTIS-75D-1000	1017	750 ft-lb	3/4
ASTIS-100D-1700	1,695 Nm	1,250 ft-lb	1



AISI

AISI / AISF Transducers connect to the AUET/MTM and ATDA analyzers and mount directly to a benchtop.

### AISI & AISF Transducers

Model*	Max Torque		Weight		W X H X D		Drive IN
	NM	IN-LB/FT-LB	KG	LB	MM	IN	
AISI-200025	2.8	25 in-lb	1.13	2.5	79 x 95 x 83	3.13 x 3.75 x 3.25	1/4
AISI-200100	11.3	100 in-lb	1.13	2.5	79 x 95 x 83	3.13 x 3.75 x 3.25	1/4
AISI-200500	56.5	500 in-lb	1.13	2.5	79 x 95 x 83	3.13 x 3.75 x 3.25	3/8
AISF-200100	135.6	100 ft-lb	2.25	5	100 x 65	4 x 3	1/2
AISF-200250	339	250 ft-lb	2.25	5	100 x 65	4 x 3	1/2
AISF-201000	1,350	1,000 ft-lb	2.8	6	100 x 65	4 x 3	1

\* See Configuration Options below to configure complete part number for AISI / AISF models.

### Auditor AISI / AISF Industry Standard Transducers Configuration Options

Base Model #	Angle	Capacity	Configuration	Expanded Range*	Digital	Drive Size	Wireless
Model # Digits 1-5	Model # Digit 6	Model # Digits 7-11	Model # Digit 12	Model # Digit 13	Model # Digit 14	Model # Digit 15	Model # Digit 16
Stationary							
AISI- (in-lb capacities)	2						2
AISF- (ft-lb capacities)	2						2

\*Standard range is 10%-100% of maximum capacity. Expanded range is 5%-100% of maximum capacity.

Transducers are available in capacities of up to 10,000 Ft-Lb. Contact an AIMCO Customer Service Associate at 1-503-254-6600, or toll free 1-800-852-1368.

# Rundown Fixtures

## Torque Measurement: Rundown Fixtures

### Features and Benefits

- Enables accurate and repeatable testing of pneumatic or electric power tools
- Mechanical Belleville system of bolt, nut or nut body, Belleville washers and main housing, 1/4" - 3/4" drive sizes, 10 in-lb - 1,200 ft-lb
- Fixtures can be ordered to simulate hard, med., or soft joints



	ARDFA-XXXXHD ARDIA-XXXXHD	ARDFA-XXXXHDS ARDIA-XXXXHDS	ARDFA-XXXXHDE ARDIA-XXXXHDE	ARDFA-XXX ARDIA-XXX
Wear-Resistant Heavy Duty	X			
Heavy Duty, Fully Encapsulated		X		
Heavy Duty, Encapsulated Washers			X	
Standard (Included w/analyzer)				X
Spline Drive				
Used in Conjunction with External Transducer				
ASTIS	X	X	X	X
AISI / AISF	X	X	X	X
ARTIS	X	X	X	X

\*Spline drive feature provides rundown control when testing pulse tools.



## AUDITOR RUNDOWN FIXTURES

To test power tools, pneumatic or electric, consistent rotational speed must be achieved. The joint rundown fixture/simulator provides the means by which the tool motor and spindle rotates freely at the start of the test cycle and then develops torque as rotation resistance increases as fastener/joint load increases. The linearity and consistency of the joint rundown fixtures/simulators vary greatly and the tool test data is a product of the variations in these rundown fixtures. Higher quality joint rundown fixtures produce torque data with less scatter.

## ARDIA Models

Model*	Recommended Torque Range		Square Drive
	NM	IN-LB	
ARDIA-10(HD)(HDE)(HDS)	.13 - 1.13	1.0 - 10	1/4"
ARDIA-25(HD)(HDE)(HDS)	.28 - 2.8	2.5 - 25	1/4"
ARDIA-50(HD)(HDE)(HDS)	.56 - 5.6	5 - 50	1/4"
ARDIA-100(HD)(HDE)(HDS)	1.3 - 11.3	10 - 100	1/4"
ARDIA-150(HD)(HDE)(HDS)	1.7 - 16.9	15 - 150	1/4"
ARDIA-250(HD)(HDE)(HDS)	2.8 - 28.3	25 - 250	3/8"
ARDIA-350(HD)(HDE)(HDS)	4 - 40	35 - 350	3/8"
ARDIA-500(HD)(HDE)(HDS)	5.6 - 56.5	50 - 500	3/8"
ARDIA-750(HD)(HDE)(HDS)	8.5 - 84.7	75 - 750	3/8"
ARDIA-1000(HD)(HDE)(HDS)	11.3 - 113	100 - 1,000	3/8"

\*Add "HD" to part numbers for wear resistant models. Add "HDS" to part numbers for fully encapsulated wear resistant models.

\*Add "HDE" to part numbers for partial encapsulated wear resistant models.

## ARDFA Models

Model*	Recommended Torque Range		Square Drive
	NM	FT-LB	
ARDFA-100(HD)(HDE)(HDS)	13.6 - 136	10 - 100	1/2"
ARDFA-150(HD)(HDE)(HDS)	20.4 - 204	15 - 150	1/2"
ARDFA-250(HD)(HDE)(HDS)	34 - 340	25 - 250	1/2"
ARDFA-500(HD)(HDE)(HDS)	67.8 - 678	50 - 500	3/4"
ARDFA-600(HD)(HDE)(HDS)	81.6 - 816	60 - 600	3/4"
ARDFA-750(HD)(HDE)(HDS)	101.7 - 1,017	75 - 750	3/4"

\* Add "HD" to part numbers for wear resistant models. Add "HDS" to part numbers for encapsulated wear resistant models.

\* Add "HDE" to part numbers for partial encapsulated wear resistant models.

# Joint Kits / Joint Simulators

## JOINT KITS

Joint kits are an essential accessory for accurate off-line testing of powered assembly tools.

- Represent production joint conditions off the production line
- Can be adjusted to include joint conditions specified by ISO 5393
- Allows free running of bolt before torque gradient
- Provide linear response. Repeatable 1/4" - 1" drive sizes, 28 - 1,695 Nm.

### AJKR & AJKS Joint Kits

Rotary Kit*	Model	Drive Size - IN
 <p>AJKR</p>	AJKR-28	1/4
	AJKR-135	3/8
	AJKR-271	1/2
	AJKR-1017	3/4
	AJKR-1695	1
Stationary Kit**	Model	Drive Size - IN
 <p>AJKS</p>	AJKS-25D	1/4
	AJKS-38D	3/8
	AJKS-50D	1/2
	AJKS-75D	3/4
	AJKS-100D	1

\* AJKR for use with ARTIS external transducers..

\*\*AJKS for use with ASTIS or ARTIS external transducers.

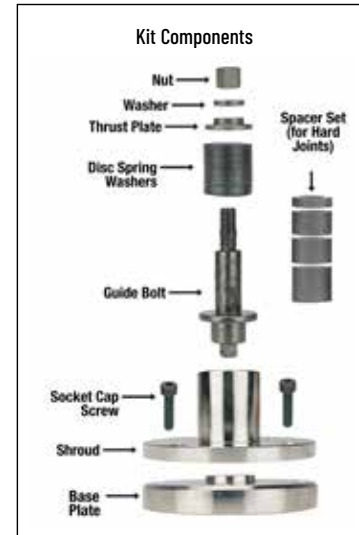

## UFT SERIES HYDRAULIC MECHANICAL JOINT SIMULATORS



- Designed for pulse tool and continuous drive tool certification and testing, UFT Joint Simulators offer the most repeatable and linear joint rate simulation on the market
- For use with ARTIS external transducers
- Bolt tightening body and hydraulic pressure loading mechanism are connected by a hydraulic pressure circuit. Ideal for ISO 5393 test procedures
- Quickly and easily simulate three joint rates by opening or closing two external valves
- Specially coated testing bolt produces over 100,000 cycles without variation or deformation



### UFT Joint Simulators

Model	Bolt Size	Torque Range		Weight	
		NM	FT-LB	LB	KG
UFT-6	M5	3.2 - 5.4	2 - 4	8	3.6
	M6	5.4 - 14.7	4 - 11		
	M8	14.7 - 31.4	11 - 23		
UFT-10 / UFT-S10	M6	6.7 - 14.7	5 - 11	43	19.5
	M8	14.7 - 31.4	11 - 23		
	M10	31.4 - 53.9	23 - 40		
UFT-16 / UFT-S16	M12	53.9 - 88.2	40 - 65	88	40
	M14	88.2 - 149	65 - 110		
	M16	149 - 190	110 - 140		
UFT-24*	M18	190 - 294	140 - 217	108	49.1
	M20	294 - 441	217 - 325		
	M24	441 - 686	325 - 506		

\* UFT-24 medium hard/soft joints only

Reaction fixture for continuous drive tools not included. Sockets included.



# Torque Measurement Cables



## Torque Measurement Cables

Model	Description	Serial Cable	Transducer Cable	Rotary	Rotary W/Angle	Stationary	Ind Std	Intellect
ICBL-USB*	Connects between COM port of display to PC	X						
ATDBLIS*	Connect to IS transducer w/ angle - 10 pin		X		X		X	
ATDBRIS*	Connect to IS transducer - 4 pin		X	X		X	X	
ICBL-10P*	Intellect transducer cable. Identification chip in cable - 10 pin connector		X		X			X
ICBL-4P*	Intellect transducer cable. Identification chip in cable - 4 pin connector		X	X		X		X
ICBL-5000L	Connect from AUET/MTM & ATDA to Intellect Transducers, Analog AISI / AISF		X			X		X
ICBL-8000DIG	Connect PC to digital transducers through digital module		X					

\* Compatible with ATDA, AUET, ADW products

## Tester / Analyzer Compatibility

Model	ATC	AUET	AUET/MTM	AUET-DC	AUET/MTM-DC	ATDA	ATDA-DC	AISWT Switchbox	ADW	ADW-DC	AIMTS Test Stand
ICBL-USB	X	X	X	X	X	X	X		X	X	
ATDBLIS		X	X	X	X	X	X				
ATDBRIS		X	X	X	X	X	X				
ICBL-10P		X	X	X	X	X	X				
ICBL-4P		X	X	X	X	X	X				
ICBL-5000L			X		X	X	X	X			X
ICBL-8000DIG											X

## Transducer Compatibility

Model	Stationary			Rotary
	ASTIS	Analog AISI/AISF	Digital AISI/AISF	ARTIS
ATDBLIS				X
ATDBRIS	X			X
ICBL-10P				X
ICBL-4P				X
ICBL-5000L		X		
ICBL-8000DIG			X	

# Index

MODEL #	PAGE	MODEL #	PAGE	MODEL #	PAGE	MODEL #	PAGE	MODEL #	PAGE
<b>A</b>									
ADW-0010K	20	APTH-120E8	23	APTH-14RE32	23	ASTIS-100D-1700	26	AUET/MTM-100-2000	10
ADW-0075K	20	APTH-120E9	23	APTH-14RT34	23	ATC-10	9	AUET/MTM-250-1600	10
ADW-0180K	20	APTH-120E10	23	APTH-14RT50	23	ATC-25	9	AUET/MTM-250-1800	10
ADW-0270K	20	APTH-120E11	23	APTH-14SD50	23	ATC-100	9	AUET/MTM-250-2500	10
ADW-0500K	20	APTH-120E12	23	APTW-25	23	ATC-150F	9	AUET/MTM-500-1200	10
ADW-1400F	20	APTH-120E13	23	APTW-50	23	ATC-250	9	AUET/MTM-500-2500(-DC)	10
AHCTS-0.5K	16	APTH-120E14	23	APTW-100	23	ATC-250F	9	<b>C</b>	
AHCTS-1.5RDF	15	APTH-120E15	23	APTW-150	23	ATC-500	9	CA150108DHD	15
AHCTS-001K	16	APTH-120E16	23	APTW-200	23	ATC-500F	9	CA1510	15
AHCTS-1RDF	15	APTH-120E17	23	APTW-340	23	ATC-750	9	CA1550	15
AHCTS-2.5K	16	APTH-120E18	23	ARDA-100(HD)(HDE)(HDS)	27	ATC-750F	9	CA1575	15
AHCTS-3/4RDF	15	APTH-120E19	23	ARDA-150(HD)(HDE)(HDS)	27	ATC-1000	9	CA2510I	15
AHCTS-005K	16	APTH-120E20	23	ARDA-250(HD)(HDE)(HDS)	27	ATC-1800	9	CA2515I	15
AHCTS-010K	16	APTH-120E50	23	ARDA-500(HD)(HDE)(HDS)	27	ATDA	12	CA2575I	15
AHCTS-025K	16	APTH-12RE50	23	ARDA-600(HD)(HDE)(HDS)	27	ATDA-DC	12	<b>I</b>	
AHCTS-0500	16	APTH-12RT25	23	ARDA-750(HD)(HDE)(HDS)	27	ATDBLIS	29	ICBL-4P	29
AHCTS-2500	16	APTH-12RT38	23	ARDIA-10(HD)(HDE)(HDS)	27	ATDBRIS	29	ICBL-10P	29
AHCTS-5000	16	APTH-12RT50	23	ARDIA-25(HD)(HDE)(HDS)	27	ATW-0100F	22	ICBL-5000L	29
AHCTS-7500	16	APTH-12SD25	23	ARDIA-50(HD)(HDE)(HDS)	27	ATW-0200F	22	ICBL-8000DIG	29
AHDTS-5025	16	APTH-12SD38	23	ARDIA-100(HD)(HDE)(HDS)	27	ATW-0500F	22	ICBL-USB	29
AIMTS-0500	18	APTH-12SD50	23	ARDIA-150(HD)(HDE)(HDS)	27	ATW-1000F	22	iTVC	24
AIMTS-2000	18	APTH-14ADP	23	ARDIA-250(HD)(HDE)(HDS)	27	ATWL-250	19	<b>S</b>	
AISF-200100	26	APTH-14BLANK	23	ARDIA-350(HD)(HDE)(HDS)	27	ATWL-750	19	SMD Tools Software	14
AISF-200250	26	APTH-140E1	23	ARDIA-500(HD)(HDE)(HDS)	27	ATWL-1000	19	<b>T</b>	
AISF-201000	26	APTH-140E13	23	ARDIA-750(HD)(HDE)(HDS)	27	Audit Manager Software	14	Tool Manager Software	13
AISI-200025	26	APTH-140E14	23	ARDIA-1000(HD)(HDE)(HDS)	27	AUET-10(-DC)	10	<b>U</b>	
AISI-200100	26	APTH-140E15	23	ARTIS-25H-2T(A)	25	AUET-50(-DC)	10	UFT-6	28
AISI-200500	26	APTH-140E16	23	ARTIS-25H-5T(A)	25	AUET-0100(-DC)	10	UFT-10	28
AISWT-4L	8	APTH-140E17	23	ARTIS-25H-20T(A)	25	AUET-250(-DC)	10	UFT-16	28
AISWT-6L	8	APTH-140E18	23	ARTIS-25S-10T(A)	25	AUET-500(-DC)	10	UFT-24	28
AJKR-28	28	APTH-140E19	23	ARTIS-38S-75T(A)	25	AUET-1000(-DC)	10	UFT-510	28
AJKR-135	28	APTH-140E21	23	ARTIS-50S-180T(A)	25	AUET-1200(-DC)	10	UFT-S16	28
AJKR-271	28	APTH-140E22	23	ARTIS-75S-250T(A)	25	AUET-1800(-DC)	10		
AJKR-1017	28	APTH-140E24	23	ARTIS-75S-500T(A)	25	AUET/MTM-10-100	10		
AJKR-1695	28	APTH-140E25	23	ARTIS-100S-1400T(A)	25	AUET/MTM-050-25	10		
AJKS-25D	28	APTH-140E27	23	ARTIS-25H-10T(A)	25	AUET/MTM-50-250	10		
AJKS-38D	28	APTH-140E30	23	ARTIS-25S-20T(A)	25	AUET/MTM-50-500(-DC)	10		
AJKS-50D	28	APTH-140E32	23	ARTIS-38S-25T(A)	25	AUET/MTM-050-600	10		
AJKS-75D	28	APTH-140E34	23	ARTIS-100S-750T(A)	25	AUET/MTM-50-1000(-DC)	10		
AJKS-100D	28	APTH-140E36	23	ASTIS-25D-11	26	AUET/MTM-0100-050	10		
APTH-12ADP	23	APTH-140E38	23	ASTIS-25D-28	26	AUET/MTM-100-500	10		
APTH-12BLANK	23	APTH-140E41	23	ASTIS-38D-135	26	AUET/MTM-100-1000	10		
APTH-120E7	23	APTH-140E118	23	ASTIS-50D-270	26	AUET/MTM-100-1200	10		
		APTH-140E138	23	ASTIS-75D-1000	26	AUET/MTM-100-1600(-DC)	10		





PRINTED IN THE U.S.A.

LIT-TM290, REV 08-03-22, ©2022 AIMCO

AIMCO CORPORATE HEADQUARTERS

10000 SE Pine Street  
Portland, Oregon 97216  
Phone: (503) 254-6600  
Toll Free: 1-800-852-1368

AIMCO CORPORATION DE MEXICO SA DE CV

Ave. Cristobal Colon 14529  
Chihuahua, Chihuahua. 31125  
Phone: (01-614) 380-1010  
Fax: (01-614) 380-1019