

AUDITOR



TORQUE MEASUREMENT SOLUTIONS 2024



For more than 50 years, AIMCO has been working with manufacturers around the world. We are the complete global source for all critical fastening and bolting solutions. AIMCO can effectively and swiftly meet your needs whether you're in Tennessee, USA fastening a 3 mm nut at 3 Nm, or in Denmark servicing wind-turbine bolts at 17,000 Nm. AIMCO provides the tools and solutions, on a global scale, that guarantee the success of your project. It is with great pride that AIMCO can say the products that we manufacture are **DESIGNED AND ASSEMBLED IN THE USA.**

TABLE OF CONTENTS

TORQUE MEASUREMENT

Torque Measurement Overview.	4
Torque Measurement Systems	7
Torque Measurement Testers	8
Torque Measurement Analyzers	11
Auditor Data Collection Software.	14
High-Capacity Test Stands.	15
Torque Wrenches	19
iTVC Torque Carts	23
Transducers.	24
Joint Kits / Joint Simulators	27
Torque Measurement Cables	28
Index	29

Torque Measurement: Overview

Torque measurement and the verification of torque tools and applied torque are an integral part of today's threaded assembly process. The method used to measure torque can affect the judgments made regarding tool performance, assembly processes and overall product quality.

DYNAMIC TORQUE

Dynamic torque is the torque produced during the actual tightening process, normally measured using rotary transducers and a torque analyzer.

Advantages:

- Reduces operator influence
- Measures applied torque
- Can also include angle of rotation as error proofing parameter

RESIDUAL TORQUE

Residual torque is the torque measured by producing an incremental amount of movement of the fastener after the actual tightening process, normally measured using a dial or digital torque wrench.

Advantages:

- Easy access to fastener
- Error proofing
- Can detect missed fasteners or joints with significant relaxation

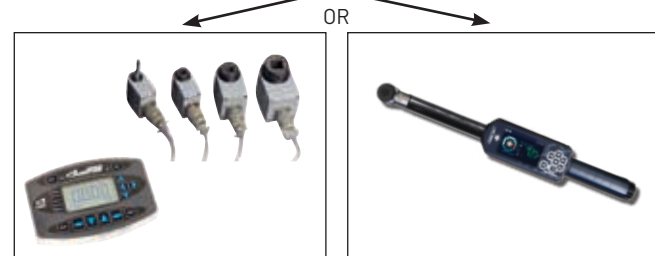
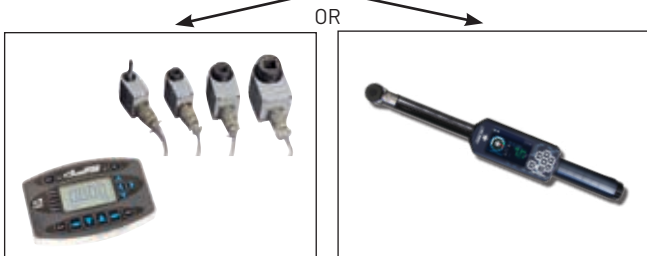
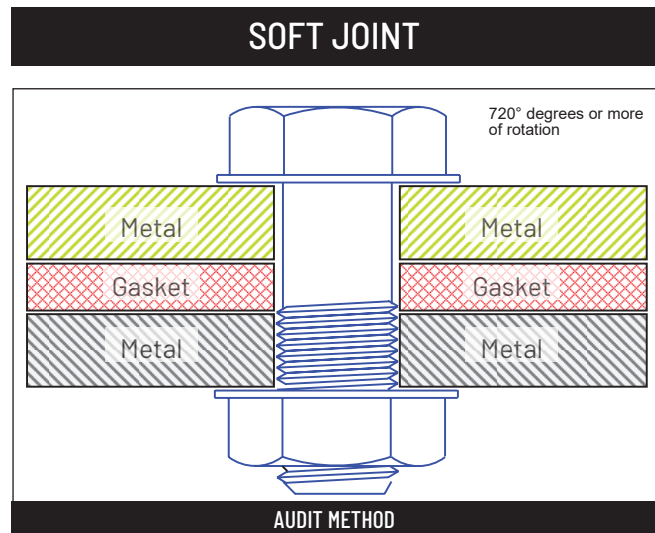
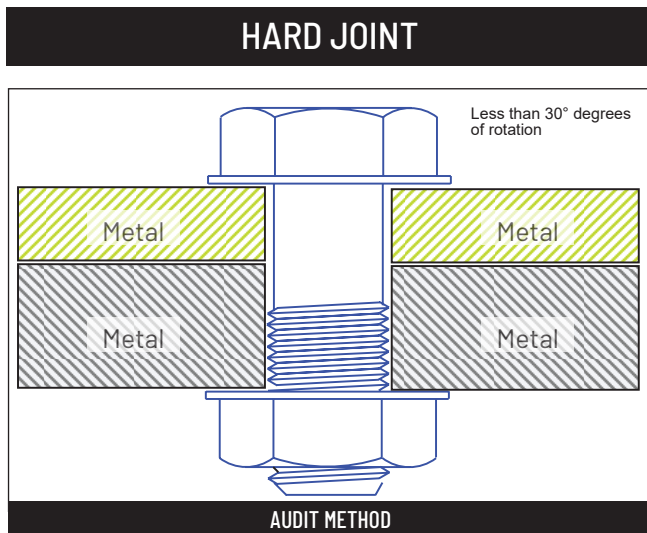

Dynamic Torque: 15 Nm

Residual Torque: 18 Nm

Dynamic Torque: 15 Nm

Residual Torque: 12 Nm

Values as examples only

Values as examples only

A hard joint, one requiring a low degree of rotation during tightening, will normally show very little relaxation after tightening. Due to the high amount of remaining clamp load and friction within the joint members, additional movement of the fastener requires additional torque energy to be applied. Therefore, Residual Torque values will be higher than Dynamic Torque values.

A soft joint, one requiring a high degree of rotation during tightening, will normally show significant amounts of relaxation after tightening. Relaxation leads to a loss of clamp load and friction within the joint members. Due to this relaxation, additional movement of the fastener requires relatively small amounts of additional torque energy and Residual Torque values will be lower than Dynamic Torque values.

Torque Measurement: Overview

Checking torque measurement before, during, and after assembly ensures quality manufacturing. Proper torque measurement is critical in many assembly operations. AIMCO utilizes years of experience to design a process around your specific auditing requirements. From simple dial wrenches to electronic data collectors and joint analyzers for R&D, AIMCO is with you every step of the way.

BEFORE ASSEMBLY

Tool Capability



Is the tool working correctly?

Testing and verifying tools under controlled conditions helps you identify accuracy and repeatability before using them in production.

Equipment used:

- Desktop testers with internal transducers
- Auditor analyzers with either stationary or rotary transducers
- UFT hydraulic joint simulators and rotary transducers

DURING ASSEMBLY

Process Capability



How does the tool work with the product being assembled?

Testing the tools during the actual process helps ensure that the process is working correctly. Variables in the parts and influences from the operator can be accounted for.

Equipment used:

- Torque Data Collectors/ Analyzers
- Auditor Rotary Transducers

AFTER ASSEMBLY

Product Capability



Does the finished product meet expectations?

Checking the product after assembly is the final opportunity to verify that product quality is satisfactory before user delivery

Equipment used:

- Click/Dial wrenches
- Electronic wrenches with Auditor analyzers
- Rotary transducers and Auditor analyzers with hand driver to move fastener

The logo for Auditor, featuring the word "AUDITOR" in a bold, italicized, sans-serif font. The letter "A" is stylized with a horizontal line through it. To the right of the word is a trademark symbol (TM).

Torque Measurement: Overview

MEASURING QUALITY – PROCESS CAPABILITY

Statistical Analysis Is An Important Step In Any Quality Control Process

One of the most widely accepted statistical indicators of process quality, and therefore product quality, is Cpk, or the process capability for a centered process. This value indicates how capable a process is and whether the results of that process are properly centered near a specific target. A capable process is one that approaches, as a limit, 100% conformance to specifications.

Cpk is a statistical value that indicates how tightly grouped a series of samples is around the target value. Cpk is a function of the Upper Specification Limit (USL), the Lower Specification Limit (LSL), the mean of the samples and the standard deviation (σ) of the samples.

$$Cpk = \text{either } \frac{(USL - \text{Mean})}{(3 \times \sigma)} \text{ or } \frac{(\text{Mean} - LSL)}{(3 \times \sigma)}, \text{ whichever is smaller.}$$

An acceptable, or capable, process will normally have a Cpk value of at least 1.33.

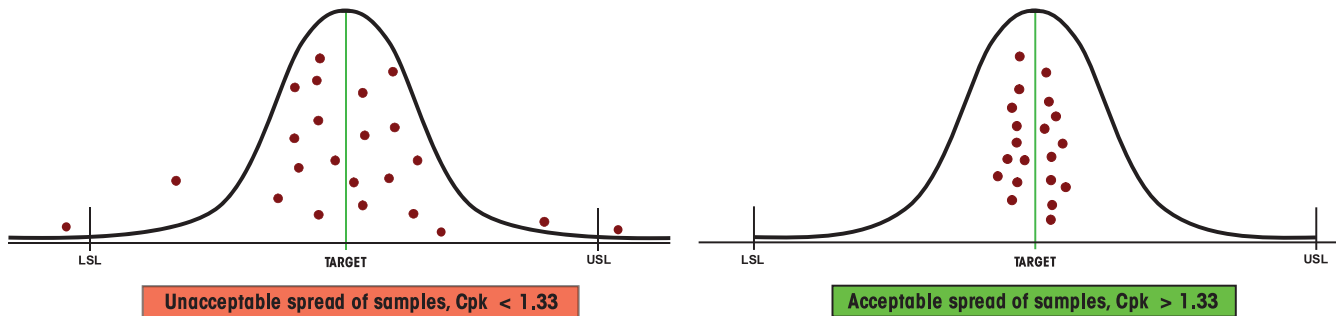

MEASURING QUALITY – CLAMP LOAD

The purpose of threaded fastening is to produce the correct amount of clamp load within the joint.

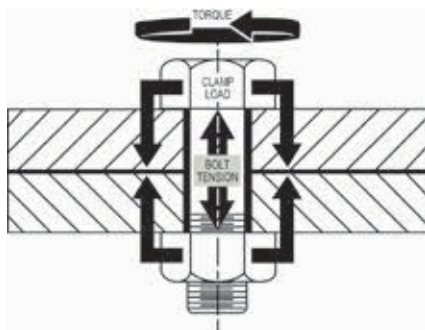

Due to the cost and difficulty of measuring clamp load during the actual assembly process, torque is used as the control parameter during tightening. Many manufacturers use torque values as the primary indicator of threaded assembly quality. However, achieving repeatable clamp load is a better indicator of joint quality.

Studies have shown that discontinuous drive tools can produce equal or better clamp load results when compared to continuous drive tools.

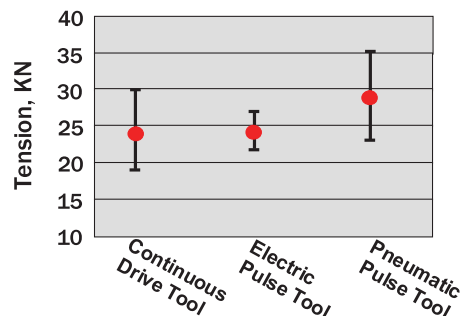
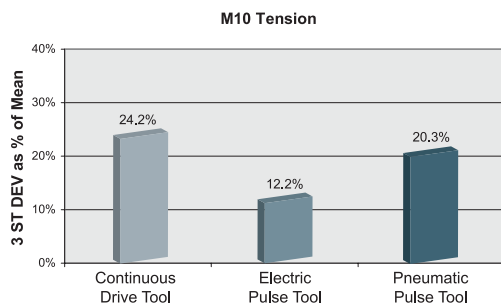

Torque Measurement: Overview



Torque Measurement Systems										
Devices	Model Series	Data Collector	Integrated Transducer	Torque Wrench	Torque Wrench Loader	External Transducer Port	Stationary Transducers -Smart	Stationary Transducers -Ind Std	Rotary Transducer -Smart	Rotary Transducer - Ind Std
Testers	ATC		X							
	AUET		X							
	AUET-DC	X	X							
	AUET/MTM		X			X				
	AUET/MTM-DC	X	X			X				
Analyzers	ATDA					X				
	ATDA-DC	X				X				
Test Stands	AHCTS*	X*	X*	X*			X*	X*	X*	X*
	AHCTS-K*	X*	X*	X*			X*	X*	X*	X*
	AHDTS*	X*	X*	X*			X*	X*	X*	X*
	AIMTS*	X*	X*	X*			X*	X*	X*	X*
Wrenches	APTW			X						
	ATW			X						
	Phoenix III	X	X	X						
	ATWL				X					
Torque Cart	iTVC*	X*	X*	X*			X*	X*	X*	X*
Transducers	ARTIS									X
	ASTIS							X		
	AISI						X			
	AISF						X			
Rundown Fixtures	ARDFA									
	ARDIA									
Joint Kits	AJKR									
	AJKS									
Joint Simulator	UFT									

*configured to customer specifications





Torque Measurement: Overview

Torque Measurement: Testers

Features and Benefits

- Heavy industrial design
- All software included
- Auditor Torque Testers are designed for intuitive and functional usability. AUET/MTM models are available with our unique dual integrated torque transducer package.

Testers are designed to audit torque wrenches and power tools, including pulse tools

					
	ATC	AUET	AUET/MTM	AUET-DC	AUET/MTM-DC
Auditor Torque Cube	Auditor Torque Cube	Auditor Universal Electronic Tester	Auditor Universal Electronic Tester - Multiple Transducer Module	Auditor Universal Electronic Tester - Data Collector	Auditor Universal Electronic Tester/Multiple transducer Module - Data Collector
	Compact vertical or horizontal bench-mount tester.	Bench mount or line side tester utilizing integrated transducer.	Bench mount or line side tester with dual integrated transducer and external transducer capacity.	Bench mount or line side tester utilizing integrated transducer. Provides data collection capability with included software to interface with PC.	Bench mount or line side tester with dual integrated transducer and external transducer capacity. Data collection capability with included software to interface with PC.
Integrated Transducer Range (values are in full scale)	1 - 1,350 Nm 100 in-oz - 1,000 ft-lb	1 - 1,000 Nm 100 in-oz - 750 ft-lb	1 - 1,000 Nm 100 in-oz - 750 ft-lb	1 - 1,000 Nm 100 in-oz - 750 ft-lb	1 - 1,000 Nm 100 in-oz - 750 ft-lb
External Transducer Capacity (Transducer sizes exceeding this range may be special ordered)			up to 5,000 ft-lb		up to 5,000 ft-lb
Vertical / Horizontal Mount	X				
Bi-directional accuracy of +/- X of indicated reading within the top 90% of the tester's capacity	1%	0.50%	0.50%	0.50%	0.50%
Data Output to PC	X	X	X	X	X
Integrated Torque Transducer	1	1	2	1	2
External Transducer Port			X		X
Number of Stored Readings	999	999	999	999	999
Adjustable Rundown Fixture Included *	1	1	2	1	2
Rechargeable NiMH Battery	X	X	X	X	X
Measurement Modes					
Peak	X	X	X	X	X
First Peak (Click)	X	X	X	X	X
Pulse	X	X	X	X	X
Track	X	X	X	X	X
Units of Measure Options	8	8	8	8	8
Tool Manager Software Included				X	X

* Included with all testers and analyzers with a range up to 1000 in-lb.

Torque Measurement Testers Used In Conjunction With

External Transducers

ASTIS - Stationary			X		X
AISI / AISF - Stationary - Analog			X		X
ARTIS - Rotary			X		X

Switch box for External Transducer

AISWT-4L > 4 Way Intellect box			X		X
AISWT-6L > 6 Way Intellect box			X		X

Cables

ICBL-USB - USB Serial > PC	X	X	X	X	X
ATDBLIS - IS Transducer w/angle (10 Pin)			X		X
ATDBRIS - IS Transducer (4 Pin)			X		X
ICBL-10P - Intellect transducer cable Identification chip in cable - 10 pin connector			X		X
ICBL-4P - Intellect transducer cable. Identification chip in cable - 4 pin connector			X		X
ICBL-5000L - Connect from AUET/MTM & ATDA to Intellect Transducers, Analog AISI / AISF			X		X

Auditor Torque Cube



AUDITOR TORQUE CUBE

The Auditor Torque Cube (ATC) is a compact, versatile desktop tester that provides a multitude of capabilities. The ATC is designed to test hand or power tools with the following:

- Peak, first peak, and track modes
- Multiple engineering units
- Manual and auto clear function
- Multiple frequency response settings
- Bi-directional use and accuracy
- Accuracy is better than 1% of indicated reading top 90% of range
- Serial data output
- Memory: 999 data samples
- Battery and/or mains powered

Because precision and quality are critical, you can depend on Auditor testers to calibrate and certify your tools. Whether you are assembling large complicated systems or small precise time pieces, AIMCO provides the best system for your application. Our instruments have been judged “best in class” by independent National Standards laboratories. Auditor Torque Cube is rugged enough to test and verify tools at “point of use” while still being accurate enough to calibrate hand and power tools.

Each tester is shipped with a mains/battery charger power cord, a hex to allen drive bit, and a bolting template. Models with max torque of 1,000 in-lb or less also include a joint rundown fixture. The ATC can be positioned vertically or horizontally for the ergonomic testing of inline or pistol grip tools.

ATC Auditor Torque Cube Models

Model	Recommended Torque Range		KG	Weight		W x H x D		Square Drive IN
	NM	IN-LB/FT-LB		LB	MM	IN		
Vertical Configuration								
ATC-10	0.13 - 1.13	1 - 10 in-lb	1.13	2.5	79 x 95 x 83	3.13 x 3.75 x 3.25	1/4	
ATC-25	0.28 - 2.83	2.5 - 25 in-lb	1.13	2.5	79 x 95 x 83	3.13 x 3.75 x 3.25	1/4	
ATC-100	1.13 - 11.3	10 - 100 in-lb	1.13	2.5	79 x 95 x 83	3.13 x 3.75 x 3.25	1/4	
ATC-250	2.83 - 28.3	25 - 250 in-lb	1.13	2.5	79 x 95 x 83	3.13 x 3.75 x 3.25	3/8	
ATC-500	5.65 - 56.5	50 - 500 in-lb	1.13	2.5	79 x 95 x 83	3.13 x 3.75 x 3.25	3/8	
ATC-750	8.47 - 84.8	75 - 750 in-lb	1.13	2.5	79 x 95 x 83	3.13 x 3.75 x 3.25	3/8	
ATC-1000	11.3 - 113	100 - 1000 in-lb	1.13	2.5	79 x 95 x 83	3.13 x 3.75 x 3.25	3/8	
ATC-1800	21.2 - 203	188 - 1,800 in-lb	1.13	2.5	79 x 95 x 83	3.13 x 3.75 x 3.25	1/2	
Horizontal Configuration								
ATC-150F	20 - 200	15 - 150 ft-lb	2.25	5	79 x 95 x 83	3.13 x 3.75 x 3.25	1/2	
ATC-250F	34 - 340	25 - 250 ft-lb	2.25	5	79 x 95 x 83	3.13 x 3.75 x 3.25	1/2	
ATC-500F	68 - 678	50 - 500 ft-lb	2.25	5	79 x 95 x 83	3.13 x 3.75 x 3.25	3/4	
ATC-750F	102 - 1,017	75 - 750 ft-lb	2.25	5	79 x 95 x 83	3.13 x 3.75 x 3.25	3/4	

Auditor Bench-Mount Testers



AUET



AUET/MTM



AUET/MTM-DC

AUDITOR UNIVERSAL ELECTRONIC TESTERS

Auditor Universal Electronic Testers (AUET) have a broad range of features to accommodate most requirements. They are designed to be bench-top mounted and are available in several configurations and various single or multiple torque ranges. Onboard memory allows you to capture 999 torque event readings. The testers are also available in file capability (DC) models that require PC software Auditor Tool Manager (ATM).

Instruments up to 1,000 in-lb are supplied with rundown adapters/joint kits. Rundown kits for larger instruments can be ordered separately. AUET/MTM units are supplied with an external transducer port and selector switch for connecting additional transducers.

AUET testers utilize the same transducers as the ATC instruments, providing the same high quality accuracy and durability. The common interface makes the Auditor tester extremely user friendly.



AUET Single Transducer Models

Model*	Recommended Torque Range	
	KGF-CM/NM	IN-OZ/IN-LB
AUET-050(-DC)	0.4 - 3.6 kgf-cm	5 - 50 in-oz
AUET-0100(-DC)	0.7 - 7.2 kgf-cm	10 - 100 in-oz
AUET-10(-DC)	1.1 - 11.5 kgf-cm	1 - 10 in-lb
AUET-50(-DC)	0.5 - 5.6 Nm	5 - 50 in-lb
AUET-100(-DC)	1.1 - 11.3 Nm	10 - 100 in-lb
AUET-250(-DC)	2.8 - 28.3 Nm	25 - 250 in-lb
AUET-500(-DC)	5.7 - 56.5 Nm	50 - 500 in-lb
AUET-1000(-DC)	11.3 - 113 Nm	100 - 1,000 in-lb
AUET-1200(-DC)	13.6 - 135.6 Nm	120 - 1,200 in-lb
AUET-1800(-DC)	20.3 - 203.4 Nm	180 - 1,800 in-lb

* Add "-DC" to part numbers for data collecting models.

Data collecting models allow multiple files/tools/applications to be associated with torque data. Requires Tool Manager software.

Custom sizes are also available. Contact an AIMCO Customer Service Associate for ordering options, 1-503-254-6600, or toll free 1-800-852-1368.

AUET/MTM Dual Transducer Models

Model**	Recommended Torque Range			
	Transducer 1	Transducer 2	Transducer 1	Transducer 2
AUET/MTM-050-25	0.04 - 0.4 Nm	0.3 - 2.8 Nm	5 - 50 in-oz	2.5 - 25 in-lb
AUET/MTM-050-600	0.04 - 0.4 Nm	6.8 - 67.8 Nm	5 - 50 in-oz	60 - 600 in-lb
AUET/MTM-0100-050	0.07 - 0.71 Nm	0.04 - 0.4 Nm	10 - 100 in-oz	5 - 50 in-oz
AUET/MTM-10-100	0.11 - 1.12 Nm	1.3 - 11.3 Nm	1.0 - 10 in-lb	10 - 100 in-lb
AUET/MTM-50-250	0.56 - 5.65 Nm	2.8 - 28.3 Nm	5.0 - 50 in-lb	25 - 250 in-lb
AUET/MTM-50-500(-DC)	0.56 - 5.65 Nm	5.7 - 56.5 Nm	5.0 - 50 in-lb	50 - 500 in-lb
AUET/MTM-50-1000(-DC)	0.56 - 5.65 Nm	11.3 - 113 Nm	5.0 - 50 in-lb	100 - 1,000 in-lb
AUET/MTM-100-500	1.13 - 11.3 Nm	5.7 - 56.5 Nm	10 - 100 in-lb	50 - 500 in-lb
AUET/MTM-100-1000	1.13 - 11.3 Nm	11.3 - 113 Nm	10 - 100 in-lb	100 - 1,000 in-lb
AUET/MTM-100-1200	1.13 - 11.3 Nm	13.6 - 135.6 Nm	10 - 100 in-lb	120 - 1,200 in-lb
AUET/MTM-100-1600(-DC)	1.13 - 11.3 Nm	18.1 - 180.8 Nm	10 - 100 in-lb	160 - 1,600 in-lb
AUET/MTM-100-2000	1.13 - 11.3 Nm	22.6 - 226 Nm	10 - 100 in-lb	200 - 2,000 in-lb
AUET/MTM-250-1600	2.82 - 28.2 Nm	18.1 - 180.8 Nm	25 - 250 in-lb	160 - 1,600 in-lb
AUET/MTM-250-1800	2.82 - 28.2 Nm	20.3 - 203.4 Nm	25 - 250 in-lb	180 - 1,800 in-lb
AUET/MTM-250-2500	2.82 - 28.2 Nm	28.2 - 282.5 Nm	25 - 250 in-lb	250 - 2,500 in-lb
AUET/MTM-500-1200	5.7 - 56.5 Nm	13.6 - 135.6 Nm	50 - 500 in-lb	120 - 1,200 in-lb
AUET/MTM-500-2500(-DC)	5.7 - 56.5 Nm	28.2 - 282.5 Nm	50 - 500 in-lb	250 - 2,500 in-lb

Custom sizes are also available. Contact an AIMCO Customer Service Associate for ordering options, 1-503-254-6600, or toll free 1-800-852-1368.

Auditor Torque Measurement Analyzers

Torque Measurement: Analyzers

Features and Benefits

- Auditor Torque Analyzers share similar features across all products and are designed for intuitive and functional usability.
- Connects to AIMCO's line of rotary and stationary transducers



	ATDA	ATDA-DC
Auditor Torque Data Analyzer		Auditor Torque Data Analyzer with Data Collection
Portable analyzer to be connected to various transducers		Portable analyzer to be connected to various transducers. Provides data collection capability with included software to interface with PC
Bi-directional	X	X
Data Output to PC	X	X
External Transducer Port	1	1
Number of stored readings	999	999
Rechargeable NiMH Battery	X	X
Digital I/O for external devices	X	X
Measurement Modes	X	X
Peak	X	X
First Peak (Click)	X	X
Pulse	X	X
Track	X	X
Measurement Units	8	8
Software Included		X

Used In Conjunction With

Transducers

AISI / AISF - Analog	X	X
AISI / AISF - Digital		
ASTIS - Stationary	X	X
ARTIS - Rotary	X	X

Wrenches

ATW	X	X
-----	---	---

Switch boxes for External Transducers

AISWT-4L > 4 Way Intellect box	X	X
AISWT-6L > 6 Way Intellect box	X	X

Cables

ICBL-USB - USB Serial > PC	X	X
ATDBLIS - IS Transducer w/ angle (10 Pin)	X	X
ATDBRIS - IS Transducer (4 Pin)	X	X
ICBL-10P - Intellect transducer cable. Identification chip in cable - 10 pin connector	X	X
ICBL-4P - Intellect transducer cable. Identification chip in cable - 4 pin connector	X	X
ICBL-5000L - Connect from AUET/MTM & ATDA to Intellect Transducer, Analog AISI / AISF	X	X

Auditor Torque Data Analyzers



AUDITOR TORQUE DATA ANALYZERS

The Auditor Torque Data Analyzer (ATDA) DC is designed to be portable or conveniently placed on a bench. The tester can be connected to various transducers, as well as transducerized wrenches and rotary or stationary transducers. The user interface is common between the ATC (Cube), AUET, AUET-DC, AUET/MTM, AUET/MTM-DC, ATDA, and ATDA-DC. All of these instruments have similar menus. Additionally, all data collector testers utilize Auditor Tool Manager for tool testing and data management.

The Auditor Torque Data Analyzer is available in two configurations:

- ATDA: A simple torque analyzer with sequential memory, 999 data samples, engineering limits, limited statistical processing average, range, Cp and CpK with serial output
- ATDA-DC: Contains all of the features of the ATDA and has additional file capability. It can associate data with file names and manage data collection with a computer and Auditor Tool Manager software

This is a great “starter” tool management system. It provides testing, archiving, and analysis of tools at single or multiple torque targets. The tool and torque data is stored in a SQL database and can be exported to Excel or any .csv spreadsheet.

ATDA Auditor Torque Data Analyzer Models

MODEL	DESCRIPTION
ATDA	Auditor Torque Data Analyzer
ATDA-DC	Auditor Torque Data Collector

Auditor Data Collection Software

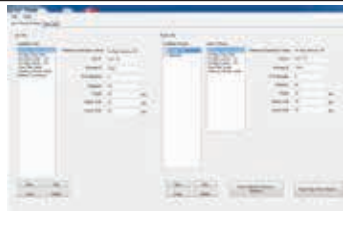
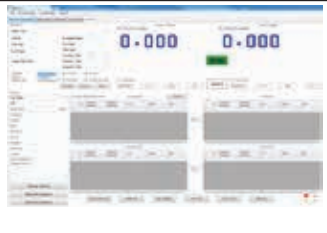
Data Collection Software		
		
Auditor Tool Manager Software	Auditor Audit Manager Software	SMD Tools Software
Test, verify, and archive tools	Comprehensive statistical analysis, data archiving, and data export	Use a PC as a torque tester/display for testers and transducers
Create a database of tools and store test results with easy-to-use software integrator to/from tester to PC	Facilitate residual auditing with digital wrenches and transducerized wrenches	Comprehensive, pre-configured, and guided testing of specific tools as well as manual testing with all testing parameters adjustable and set by the user

Compatibility		
Desktop or PC		X
ATC		X
ATDA		X
ATDA-DC	X	X
AUET		X
AUET-DC	X	X
AUET/MTM		X
AUET/MTM-DC	X	X
ARTIS		
ARTIS-DIG		X
AISI/AISF		
AISI/AISF (Digital)		X
iTVC Torque Cart		X

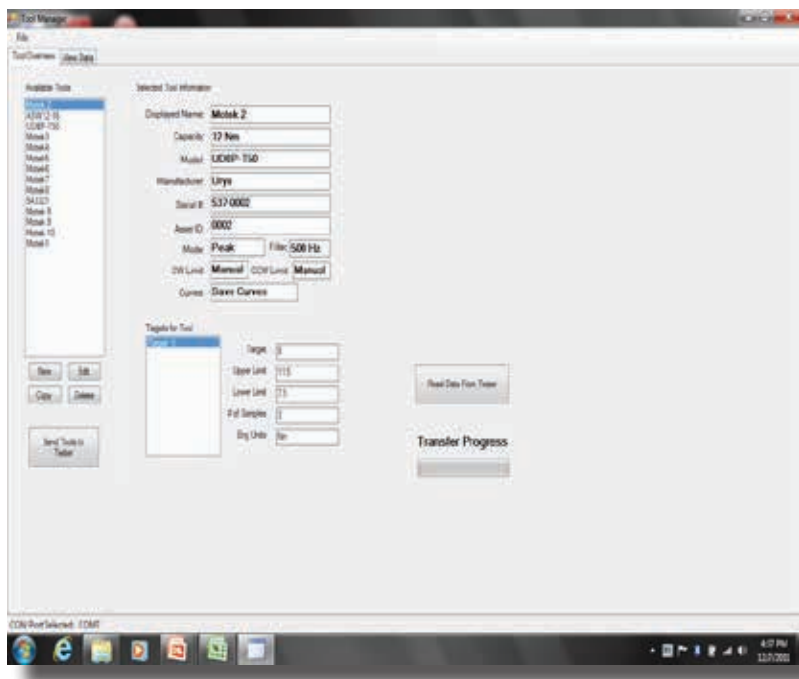

AUDITOR TOOL MANAGER SOFTWARE

Tool Manager Software is included with the purchase of AUET-DC and AUET/MTM-DC data-collecting torque testers. Create a database of tools and store test results with this easy-to-use software integrator to/from tester to PC.

Tool Manager Software, Tool Overview Screen

Auditor Data Collection Software

AUDITOR AUDIT MANAGER SOFTWARE

Audit Manager Software is included with the purchase of ATDA-DC data collecting torque analyzers. The View Data tab allows you to look at the collected data and the trace file. This data can be exported to Excel as a .csv file and displayed by Excel charts. The trace file displays the data in a torque/time graph and allows the user to supersede the move-on reading selected by the wrench by visually discerning via the trace where the fastener started to rotate. When selecting a single job the average, range, sigma, Cp, and CpK values are listed.

Audit Manager Software,
Job and Route Builder Screen

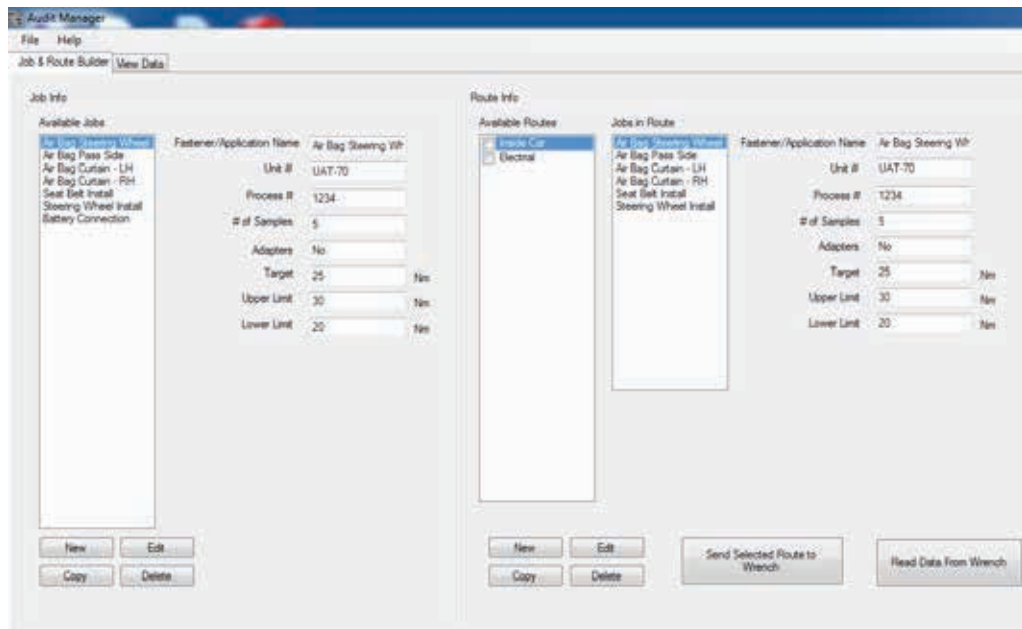

SMD TOOLS SOFTWARE

A digital signal between a PC and a digital transducer allows SMD Tools software to operate independently of a tester or analyzer to collect and store data in Microsoft Excel.

Tool Manager and Test Manager databases within the software stores tool details and test processes for easy access in the Cert Manager platform



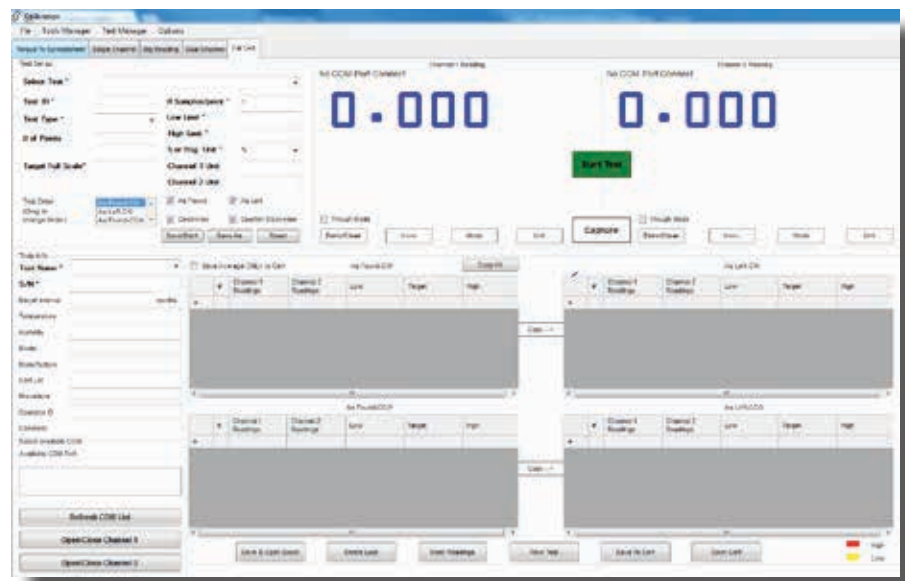

Auditor branded analyzers and testers can network with this software to produce and store real-time data



SMD Tools Software, Cal Cert Screen

Auditor High-Capacity Test Stands



Torque Measurement: High Capacity Test Stands

Features and Benefits <ul style="list-style-type: none"> Advanced test stations for larger tools and higher torque output Configured to meet application requirements Durable industrial grade devices 				
	AHCTS	AHCTS-K	AHDTS	AIMTS
	Auditor High Capacity Test Stand	Auditor High Capacity Test Stand - Hydraulic	Auditor High Capacity Test Stand Dual Transducer	Auditor High Capacity Impact Test Stand
	Designed for testing tools with continuous rotating output spindles and pulse tools.	Specifically designed for hydraulic wrenches testing.	Two transducers, one for rotary tools and one for hydraulic tools. Includes rundown & reaction fixtures with a single display.	Ideal for testing impact wrenches and is recommended to utilize rundown fixtures when testing impacts.
Capacity	6,750 Nm	33,750 Nm	33,750 Nm	2,700 Nm

Accessories

Rundown fixtures				
AHCTS-3/4RDF	X		X	
AHCTS-1RDF	X		X	
AHCTS-1.5RDF	X		X	

Adapters

		AHCTS	AHCTS-K	AHDTS	AIMTS
Square to Square Drive Adapters*					
	CA1510 1-1/2" Male to 1" Female	X		X	
	CA1550 1-1/2" Male to 1/2" Female	X		X	
	CA1575 1-1/2" Male to 3/4" Female	X		X	
Insert Adapters*					
	CA2510I 2-1/2" Male to 1" Female	X	X	X	
	CA2515I 2-1/2" Male to 1-1/2" Female	X	X	X	
	CA2575I 2-1/2" Male to 3/4" Female	X	X	X	
Square to Hex Drive Adapters*					
	CA150108DHD 1-1/2" Male to 1-1/2" Male Hex		X		

* Partial List. Contact An Aimco Customer Service Associate For More Options, 1-503-254-6600, Or Toll Free 1-800-852-1368.

Auditor High-Capacity Test Stands



AHCTS-5000

AHCTS TEST STAND FOR ROTATING TOOLS

Designed for testing tools with continuous rotating output spindles. The test stand includes a rundown fixture, bushing for side load support, reaction post or reaction paddles, transducer and torque analyzer display.

AHCTS Test Stand Models

Model	Description
AHCTS-0500	3/4" Square Drive w/rundown fixture
AHCTS-2500	1.5" Square Drive w/rundown fixture
AHCTS-5000	1.5" Square Drive w/rundown fixture
AHCTS-7500	1.5" Square Drive w/rundown fixture

Please refer to Configuration Options on the following page for required ordering options.



AHCTS-001K

AHCTS-K STAND FOR HYDRAULIC TOOLS

The AHCTS-K stands are specifically designed for hydraulic wrench testing. Hydraulic wrenches have very low profiles but very high torque output, therefore, working height must be minimized to prevent side loading which could lead to errors in data or damage to tool or reaction devices.

Either stand can be ordered with options such as extension legs, casters, embedded or attached torque analyzers with various rundown fixtures and reaction devices. Contact an AIMCO Customer Service Associate for additional information, 1-503-254-6600, or toll free 1-800-852-1368.

AHCTS-K Test Stand Models

Model	Description	Capacity Ft-Lb
AHCTS-0.5K	3/4" Square Drive w/reaction device	500
AHCTS-001K	1" Square Drive w/reaction device	1,000
AHCTS-2.5K	1.5" Square Drive w/reaction device	2,500
AHCTS-005K	1.5" Square Drive w/reaction device	5,000
AHCTS-010K	1.5" Square Drive w/reaction device	10,000
AHCTS-025K	2" Square Drive w/reaction device	25,000

Please refer to Configuration Options on following page for required ordering options.

Optional Pelican Case shown (ordered separately)



25503

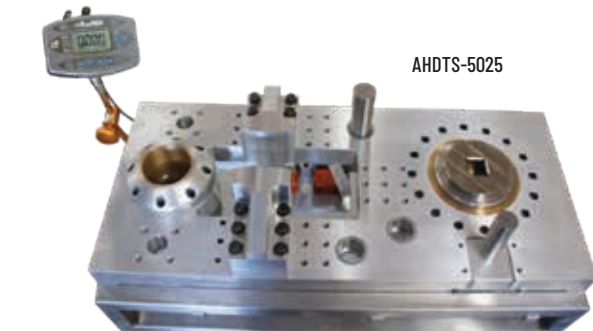

AHDTs-5025

AHDTs DUAL TEST STAND FOR ROTATING AND HYDRAULIC TOOLS

This stand has two transducers embedded into the base, one for rotary tools and one for hydraulic tools. It comes with rundown and reaction fixtures and one display.

AHDTs Dual Test Stand Models

Model	Description
AHDTs-5025	1.5" Sq Dr dual station w/rundown fixture and reaction devices

Contact an AIMCO Customer Service Associate for ordering options, 1-503-254-6600, or toll free 1-800-852-1368.

Auditor High-Capacity Test Stands

AHCTS Series High Capacity Test Stands for Rotary and Hydraulic Tools Configuration Options

Base Model Number	Display	Legs	Base Size	Rundown Fixture Capacity (ft-lb)	Reaction Post	Casters	Articulated Arm and Mount	Digital Module
AHCTS-xxxx	1 = ATDA 2 = No Embedded Display 3 = ATDA-DC 6 = Standard Embedded Display (1, 3, 4, 5 include articulated arm)	1 = 6" 2 = No legs (Standard) 3 = 18" 4 = Custom	0 = 8 x 8" 1 = 12 x 12" 3 = 14 x 19" (Standard) 4 = 18 x 24" 5 = 18 x 36" 6 = NA	1 = 500 2 = No 3 = 1,000 4 = 2,500 5 = 5,000 6 = 7,500 7 = 1.5" Kit Max. capacity 7,500 Ft-Lb 8 = 2.5" Kit Max. capacity 7,500 Ft-Lb	1 = Single 6" Post and Paddles 2 = No 3 = Multiple Posts 6" 4 = Paddles 5 = Custom 6 = Single 9" Post and Paddles 7 = Multiple Posts 9"	1 = Yes 2 = No	1 = Yes 2 = No	1 = Yes (for Tablet or PC direct) 2 = No
Model Number Digits 1-10	Model # Digit 11	Model # Digit 12	Model # Digit 13	Model # Digit 14	Model # Digit 15	Model # Digit 16	Model # Digit 17	Model # Digit 18

Auditor High Capacity Test Stand for Rotary Tools

AHCTS-0500 680 Nm / 500 ft-lb			0, 1, or 3					
AHCTS-1000 1,360 Nm / 1,000 ft-lb			0, 1, or 3					
AHCTS-2500 3,400 Nm / 2,500 ft-lb			0, 1, or 3					
AHCTS-5000 6,800 Nm / 5,000 ft-lb			0, 1, or 3					
AHCTS-7500 10,200 Nm / 7,500 ft-lb			0, 1, or 3					

Auditor High Capacity Test Stand for Hydraulic Tools

AHCTS-0.5K 680 Nm / 500 ft-lb			0-5 (3-5 come with casters)	2				
AHCTS-001K 1,360 Nm / 1,000 ft-lb			0-5 (3-5 come with casters)	2				
AHCTS-2.5K 3,390 Nm / 2,500 ft-lb			0-5 (3-5 come with casters)	2				
AHCTS-005K 6,800 Nm / 5,000 ft-lb			0-5 (3-5 come with casters)	2				
AHCTS-010K 13,600 Nm / 10,000 ft-lb			0-5 (3-5 come with casters)	2				
AHCTS-025K 34,000 Nm / 25,000 ft-lb			0-5 (3-5 come with casters)	2				
AHCTS-050K 68,000 Nm / 50,000 ft-lb			0-5 (3-5 come with casters)	2				

Auditor High-Capacity Test Stands

AIMTS TEST STAND FOR IMPACT TOOLS

Obtain accurate test results with the AIMTS Series Impact Test Stand. When used with an Auditor ATDA Analyzer or AUET/MTM Desktop Torque Tester, the tool's performance data can be recorded and stored. Each Auditor Analyzer comes standard with PC-based software to store and organize data for use within a quality system. It is necessary to bolt the AIMTS to a bench. We also recommend that a rundown fixture always be used for testing impacts.

FEATURES AND BENEFITS

- Housing designed with mounting holes for bolting to bench
- Transducer designed with spline interface to rundown fixture for durability
- Rundown fixture is configurable from a "soft" joint rate to a "hard" joint rate

AIMTS Test Stand Models

Model	Capacity		Weight		Dimensions (W x H x D)		
	FT-LB	Nm	LB	KG	IN	MM	Sq. Dr.
AIMTS-0050	5 - 50	7 - 70	10	4.5	8 x 10 x 4	203 x 254 x 102	3/4"
AIMTS-0250	25 - 250	34 - 340	10	4.5	8 x 10 x 4	203 x 254 x 102	3/4"
AIMTS-0500	50 - 500	68 - 680	10	4.5	8 x 10 x 4	203 x 254 x 102	3/4"
AIMTS-2000	200 - 2,000	271 - 2,710	16	7.3	10 x 12 x 8	254 x 305 x 203	1.5"
AIMTS-2500	250 - 2,500	340 - 3,400	16	7.3	10 x 12 x 8	254 x 305 x 203	1.5"
AIMTS-5000	500 - 5,000	678 - 6,780	16	7.3	10 x 12 x 8	254 x 305 x 203	1.5"

Refer to Configuration Options below for required ordering options.



AIMTS-2000
Test stand for large impact tools



AIMTS-0500
Test stand for small impact tools. ATDA-DC Torque Data Analyzer sold separately.





AIMTS Series High Capacity Impact Test Stand Configuration Options

Base Model #	Display	Legs	Base Size	Rundown Fixture Capacity (ft-lb)*		Options	Digital Module
AIMTS-xxxx	1 = ATDA 2 = No Embedded Display 3 = ATDA-DC	1 = 6" 2 = No legs (Standard) 3 = 18" 4 = Custom	6 = Bench Stand	1 = 500 2 = No 3 = 2,000 4 = 50 5 = 5,000	6 = 10,000 7 = 20,000 8 = 250 9 = 2,500	Not available for AIMTS test stands. Enter 222 for model # digits 15-17	1 = Yes (for Tablet or PC direct) 2 = No
Model Number Digits 1-10	Model Number Digit 11	Model Number Digit 12	Model Number Digit 13	Model Number Digit 14		Model Number Digits 15-17	Model Number Digit 18
AIMTS-0050 68 Nm / 50 ft-lb		2	6	4		222	
AIMTS-0250 340 Nm / 250 ft-lb		2	6	8		222	
AIMTS-0500 680 Nm / 500 ft-lb		2	6	1		222	
AIMTS-2000 2,720 Nm / 2,000 ft-lb		2	6	3		222	
AIMTS-2500 3,390 Nm / 2,500 ft-lb		2	6	9		222	
AIMTS-5000 6,780 Nm / 5,000 ft-lb		2	6	5		222	

* Ordering more than one rundown fixture is highly recommended if you're doing a lot of testing. Having multiple rundown fixtures ensures that you have spares when dealing with heat issues. AIMTS test stands are available in capacities of up to 20,000 ft-lb. Capacities other than what is shown here are quoted separately. Contact an AIMCO Customer Service Associate at 1-503-254-6600, or toll free 1-800-852-1368.

Torque Wrenches

Torque Measurement: Torque Wrenches			
Features and Benefits <ul style="list-style-type: none"> Options from Simple to Sophisticated <ul style="list-style-type: none"> Residual or Dynamic Measuring Tactile (Click) or Digital Connectivity <ul style="list-style-type: none"> Auditor Devices (ATW) Broad Range of Protocols (Phoenix III) Durable <ul style="list-style-type: none"> Designed for Factory Floor Environments Used in Production Applications or Quality Checks 			
	APTW	ATW	Phoenix III
	Auditor Preset Torque Wrench	Auditor Electronic Torque Wrench	Phoenix III Digital Torque Wrench
Torque Range	5 - 340 Nm 4 - 250 ft-lb	5 - 200 Nm 4 - 148 ft-lb	1.5 - 1,200 Nm 1.1 - 885 ft-lb
	Interchangeable FACOM type heads. Preset uses proprietary adjustment tool to guard against unauthorized setting changes	Aka "Transducer on a Stick." Connectivity to Auditor™ testers and data analyzers	Transducerized digital torque wrench with Production and Quality functionality. Optional WiFi technology for wireless communication over Open Protocol
Bi-Directional accuracy of +/- X of indicated reading within the top 90% of the tester's capacity	3%	0.50%	0.1%
Software Included	X	X	X

Used In Conjunction With			
ATDA (DC) Data Analyzer		X	
AUET (DC) Tester		X	
AUET/MTM (DC) Tester		X	

Torque Wrench Loaders



For calibration of all types of torque wrenches, eliminating human variables for more accurate measurement.

ATWL-250	Torque range up to 340 Nm / 250 ft-lb
ATWL-750	Torque range up to 1,020 Nm / 750 ft-lb
ATWL-1000	Torque range up to 1,360 Nm / 1,000 ft-lb

Auditor Preset Torque Wrenches

APTW Preset Torque Wrenches

Auditor's APTW preset wrenches provide a flexible, easy way to audit fastener torque. A wide range of interchangeable heads provide flexibility and convenience.

FEATURES AND BENEFITS



- Easy-to-use preset wrenches for fastener torque auditing
- Torque ranges from 5 – 340 Nm
- User friendly, sleek, ergonomic design
- Tactile feedback on achievement of preset torque
- Proprietary adjustment tool guards against unauthorized setting changes
- Wide range of interchangeable heads provide flexibility and convenience
- +/- 3% accuracy when used in clockwise or counterclockwise directions







APTW Torque Wrench Models

WRENCH MODEL	TORQUE RANGE	INSERT ACCEPTED
APTW-25	5 - 25 Nm	12 mm
APTW-50	10 - 50 Nm	12 mm
APTW-100	20 - 100 Nm	12 mm
APTW-150	30 - 150 Nm	12 mm
APTW-200	40 - 200 Nm	14 mm
APTW-340	60 - 340 Nm	14 mm



TORQUE WRENCH INSERTS

Adapters	Description
 APTH-12ADP	9 x 12 M to 14 x 18 F
 APTH-14ADP	14 x 18 M to 9 x 12 F

Ring End Inserts	Description
 APTH-12RE50	1/2" Ring End, 12 mm
 APTH-14RE32	32 mm Ring End, 14 mm

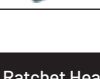
Square Drive Inserts	Description	
	9 x 12	
	APTH-12SD25	1/4" Sq. Dr.
	APTH-12SD38	3/8" Sq. Dr.
	APTH-12SD50	1/2" Sq. Dr.
	14 x 18	APTH-14SD50

Blank End Inserts	Description
 APTH-12BLANK	12 mm
 APTH-14BLANK	14 mm

Ratchet Heads	Description	
	9 x 12	
	APTH-12RT25	1/4" Sq. Dr.
	APTH-12RT38	3/8" Sq. Dr.
	APTH-12RT50	1/2" Sq. Dr.
	14 x 18	APTH-14RT50
	APTH-14RT34	3/4" Sq. Dr.

Open End Head Inserts							
	Model	Description	14 x 18				
		9 x 12		14 x 18			
	APTH-120E7	7 mm OE	APTH-140E1	1" OE	APTH-140E25	25 mm OE	
	APTH-120E8	8 mm OE	APTH-140E13	13 mm OE	APTH-140E27	27 mm OE	
	APTH-120E9	9 mm OE	APTH-140E14	14 mm OE	APTH-140E30	30 mm OE	
	APTH-120E10	10 mm OE	APTH-140E15	15 mm OE	APTH-140E32	32 mm OE	
	APTH-120E11	11 mm OE	APTH-140E16	16 mm OE	APTH-140E34	34 mm OE	
	APTH-120E12	12 mm OE	APTH-140E17	17 mm OE	APTH-140E36	36 mm OE	
	APTH-120E13	13 mm OE	APTH-140E18	18 mm OE	APTH-140E38	38 mm OE	
	APTH-120E14	14 mm OE	APTH-140E19	19 mm OE	APTH-140E41	41 mm OE	
	APTH-120E15	15 mm OE	APTH-140E21	21 mm OE	APTH-140E118	1-1/8" OE	
	APTH-120E16	16 mm OE	APTH-140E22	22 mm OE	APTH-140E138	1-3/8" OE	
	APTH-120E17	17 mm OE	APTH-140E24	24 mm OE			
	APTH-120E18	18 mm OE					
	APTH-120E19	19 mm OE					
	APTH-120E20	20 mm OE					
	APTH-120E50	1/2" OE					

Auditor Electronic Torque Wrenches

ATW Electronic Torque Wrenches

Precise Tightening and Auditing of Your Assembly Applications

"TRANSDUCERS ON A STICK"

- Non-Length Dependent – Where the operator's hand is positioned during use has no effect on torque readings
- Available in Industry Standard (IS) or Intelligent (Intellect) Configurations – Transducer is compatible with a wide variety of IS style instruments or Auditor Intellect instruments that self recognize the transducer
- Durable – Steel, Aluminum and Carbon Fiber construction provide optimal strength and weight. Transducer supplied with overload capacity of 150% of full scale
- Accurate – Torque readings are accurate to 1% of indicated reading in top 95% of full scale



ATW Torque Wrench Models

Model	Torque Range		Square Drive
	NM	FT-LB	IN
ATW-0100F	14 - 136	10 - 100	3/8
ATW-0200F	27 - 272	20 - 200	1/2
ATW-0500F	68 - 680	50 - 500	3/4
ATW-1000F	136 - 1,360	100 - 1,000	1

Required Accessory: ATDBRIS IS cable to connect Auditor ATDA instrument.

The Auditor logo features the word "AUDITOR" in a bold, italicized, sans-serif font. Above the letter "O" is a stylized graphic of a torque wrench head with three horizontal lines extending from it. A trademark symbol (TM) is located to the right of the logo.

Phoenix III Digital Torque Wrenches

Phoenix III Transducerized Digital Torque Wrench

Quality Assurance Moves to the Next Level

The Phoenix III transducerized digital torque wrench sets a new standard for quality in Production or Auditing with a hand-held wrench. With Ranges from 1.5 - 600 Nm and available options up to 1,200 Nm, the Phoenix III covers a wide range of application demands and joint analysis requirements. Optional integrated Wi-fi technology expands the possibilities of reporting in Industry 4.0 methodologies.

FEATURES AND BENEFITS

- **Ultimate Flexibility:** Multiple Tightening Modes/Strategies
 - Free Test Mode: Track and Peak for testing without logging results.
 - Two Wrenches in One: Production/QA Functionality with multiple strategies
 - Torque Control (TC)
 - Torque Control + Angle Monitor (TC+AM)
 - Torque Control + Angle Control (TC+AC)
 - Breakaway
- **Easy Programming:** Configure Wrench through hassle-free TW Config software that is provided free of charge. Entries can be made using onboard wrench touchscreen or through connected PC
- **Industry 4.0:** Integrated 2.4Ghz Wi-fi module enables wireless communication over Open Protocol
- **Clear Results:** A 2.8" color display provides clear visualization of results with intuitive icons.
- Optional integrated barcode scanner module
- Wrench provides backup and restore of file settings. Data exportable in most industry-standard formats. Collected data can be reported to MSqnet software for production (MSqnet STA, TPC) and quality (MSqnet QA) applications
- 16 GB internal memory allows you to store up to 1,000,000 rundowns and traces, as well as 4,000 pscts
- Li-ion 3.7V, 3,500 mAh battery provides 10 hours of continuous operation



Phoenix III Electronic Torque Wrench

Model*	Torque Range		End Connector	Length (minus insert)		Weight	
	Nm	Ft-Lb		mm	in	kg	lb
Phoenix III-15nm	1.5 - 15	1.1 - 11	9x12	426	16.8	0.95	2.1
Phoenix III-30nm	3 - 30	2.2 - 22	9x12	426	16.8	0.95	2.1
Phoenix III-70nm	7 - 70	5.2 - 52	9x12	488	19.2	1.00	2.2
Phoenix III-100nm	10 - 100	7.4 - 74	9x12	488	19.2	1.03	2.3
Phoenix III-200nm	20 - 200	14.8 - 148	14x18	615	24.2	1.57	3.5
Phoenix III-300nm	30 - 300	22 - 220	14x18	765	30.1	1.69	3.7
Phoenix III-400nm	40 - 400	29.5 - 295	14x18	866	34.1	1.89	4.2
Phoenix III-600nm	60 - 600	44.3 - 443	14x18	1,050	41.3	2.02	4.5

* Common models shown. Models with capacity up to 1,200 Nm (885 ft-lb) available by request



iTVC Torque Cart



AIMCO's iTVC Torque Cart is designed for "lineside" or "point of use" tool validation and calibration. Our torque carts allow testing of tools on repeatable joint simulators and "in process" use on production joints, allowing users to identify process capability. Multiple torque cart configurations are available with simple to sophisticated options:

- Manual push carts equipped with simple torque testers
- Manual push carts equipped with data collectors and database application software
- Self propelled cart with computer and relational database application
- Driven cart with computer and relational database application



FEATURES AND BENEFITS

- For testing on repeatable joint simulators or actual production joints
- Mobile test carts can be configured for testing continuous and discontinuous drive tools, including DC electric, clutch, battery, impulse, and torque wrenches
- Each cart is customizable to meet testing needs from 1 – 1,400 Nm
- Data management software options are available to suit specific audit or asset-tracking needs
- Torque wrench loaders are configurable to suit wrench populations

Carts can be equipped to specific customer requirements. Ancillary test stands up to 50,000 ft-lb available. Contact an AIMCO Customer Service Associate for a quote or for more details, 1-503-254-6600, or toll free 1-800-852-1368.



	Model	Description	Low Torque		High Torque			
			NM	FT-LB	NM	FT-LB		
UFT	Mobile-Powered							
	iTVC.A	Torque Cart, UFT Mobile Base #						
	iTVC.A2XXXXXX	NO JOINTS	0	0	0	0		
	iTVC.A2XBCXXX	2 UFTs	15	11	190	140		
	iTVC.A2XBCDXX	3 UFTs	15	11	686	506		
	iTVC.A2ABCDXX	4 UFTs	1	0.7	686	506		
	iTVC.A2ABCDEP	4 UFTs, 1 AJKR, Printer	1	0.7	1,400	1,033		
	Manual							
	iTVC.A1XXXXXX	Torque Cart, UFT Manual Base #						
	iTVC.A1XBCXXX	2 UFTs	15	11	190	140		
	iTVC.A1XBCDXX	3 UFTs	15	11	686	506		
	iTVC.A1ABCDXX	4 UFTs	1	0.7	686	506		
	iTVC.A1ABCXEX	3 UFTs, 1 AJKR	1	0.7	1,400	1,033		
	iTVC.A1ABCDEP	4 UFTs, 1 AJKR	1	0.7	1,400	1,033		
AJKR	Mobile-Powered							
	iTVC.B2XXXXXX	Torque Cart, AJKR Mobile Base #						
	iTVC.B2XBCXX	2 joints	27	20	271	200		
	iTVC.B2XBCEX	3 joints	27	20	1,400	1,033		
	iTVC.B2ABCCEP	4 joints	6	4.4	1,400	1,033		
	Manual							
	iTVC.B1XXXXXX	Torque Cart, AJKR Manual Base #						
	iTVC.B1XBCXX	2 joints	27	20	271	200		
	iTVC.B1XBCEX	3 joints	27	20	1,400	1,033		
	iTVC.B1ABCCEP	4 joints	6	4.4	1,400	1,033		
BASE	Mobile-Powered							
	iTVC.X2X	Cart, no computer	–	–	–	–		
	iTVC.X2A	Cart, w/computer	–	–	–	–		
	Manual							
	iTVC.X1X	Cart, no Computer	–	–	–	–		
iTVC.X1A	Cart, w/Computer	–	–	–	–			

Transducers

Torque Measurement: Transducers

Features and Benefits Superior:

- Accuracy
- Compatibility
- Durability

Auditor offers multiple styles of transducers in various configurations. Industry standard transducers (2mv/v) and intellect transducers for Auditor instruments that reduce configuration set up time.

	Rotary	Stationary	
			
	ARTIS	ASTIS	AISI - AISF*
	Auditor Rotary Transducer Industry Standard	Auditor Stationary Transducer Industry Standard	Auditor Industry Standard Stationary

Used in Conjunction with Analyzer

AUET	X		
AUET/MTM	X	X	X
ATDA	X	X	X

* See Configuration Options on following page to configure complete part number for AISI / AISF models. Please contact an AIMCO Customer Service Associate for additional information, 1-503-254-6600, or toll free 1-800-852-1368.

AUDITOR ROTARY TRANSDUCCERS

Suitable for use with all continuous drive tools, impulse tools and torque wrenches.



ARTIS Series

Model	Drive IN	Max Torque		Weight LB
		NM	IN-LB/FT-LB	
ARTIS-25H-2T(A)	1/4 Hex	2	18 in-lb	1.0
ARTIS-25H-5T(A)	1/4 Hex	5	44 in-lb	1.0
ARTIS-25H-10T(A)	1/4 Hex	10	88 in-lb	1.0
ARTIS-25H-20T(A)	1/4 Hex	20	180 in-lb	1.0
ARTIS-25S-10T(A)	1/4 Sq.	10	88 in-lb	1.0
ARTIS-25S-20T(A)	1/4 Sq.	20	180 in-lb	1.0
ARTIS-38S-25T(A)	3/8 Sq.	25	225 in-lb	1.2
ARTIS-38S-75T(A)	3/8 Sq.	75	50 ft-lb	1.2
ARTIS-50S-180T(A)	1/2 Sq.	180	130 ft-lb	1.5
ARTIS-75S-250T(A)	3/4 Sq.	250	180 ft-lb	2.2
ARTIS-75S-500T(A)	3/4 Sq.	500	370 ft-lb	2.2
ARTIS-100S-750T(A)	1 Sq.	750	553 ft-lb	4.0
ARTIS-100S-1400T(A)	1 Sq.	1400	1,025 ft-lb	4.0

*Add "A" to the end of the part number to indicate torque/angle transducer.

AUDITOR™

Transducers

AUDITOR STATIONARY TRANSDUCERS

Stationary Transducers with joint rundown fixtures and, where applicable, bench stands.



ASTIS

ASTIS industry standard transducers can be used with multiple analyzers.

ASTIS Transducers

Model	NM	Max Torque		Drive IN
		IN-LB/FT-LB		
ASTIS-25D-11	11	100 in-lb		1/4
ASTIS-25D-28	28	250 in-lb		1/4
ASTIS-38D-135	135	100 ft-lb		3/8
ASTIS-50D-270	270	200 ft-lb		1/2
ASTIS-75D-1000	1017	750 ft-lb		3/4
ASTIS-100D-1700	1,695 Nm	1,250 ft-lb		1



AISI

AISI / AISF Transducers connect to the AUET/MTM and ATDA analyzers and mount directly to a benchtop.

AISI & AISF Transducers

Model*	Max Torque		Weight		W X H X D		Drive IN
	NM	IN-LB/FT-LB	KG	LB	MM	IN	
AISI-200025	2.8	25 in-lb	1.13	2.5	79 x 95 x 83	3.13 x 3.75 x 3.25	1/4
AISI-200100	11.3	100 in-lb	1.13	2.5	79 x 95 x 83	3.13 x 3.75 x 3.25	1/4
AISI-200500	56.5	500 in-lb	1.13	2.5	79 x 95 x 83	3.13 x 3.75 x 3.25	3/8
AISF-200100	135.6	100 ft-lb	2.25	5	100 x 65	4 x 3	1/2
AISF-200250	339	250 ft-lb	2.25	5	100 x 65	4 x 3	1/2
AISF-201000	1,350	1,000 ft-lb	2.8	6	100 x 65	4 x 3	1

* See Configuration Options below to configure complete part number for AISI / AISF models.

Auditor AISI / AISF Industry Standard Transducers Configuration Options

Base Model #	Angle	Capacity	Configuration	Expanded Range*	Digital	Drive Size	Wireless
Model # Digits 1-5	Model # Digit 6	Model # Digits 7-11	Model # Digit 12	Model # Digit 13	Model # Digit 14	Model # Digit 15	Model # Digit 16
	2 = No	00025 = 25 In-Lb / 25 Ft-Lb 00050 = 50 In-Lb / 50 Ft-Lb 00100 = 100 In-Lb / 100 Ft-Lb 00250 = 250 In-Lb / 250 Ft-Lb 00350 = 350 In-Lb / 350 Ft-Lb 00500 = 500 In-Lb / 500 Ft-Lb 00600 = 600 In-Lb / 600 Ft-Lb 00750 = 750 In-Lb / 750 Ft-Lb 01000 = 1,000 In-Lb / 1,000 Ft-Lb	1 = Bench Stand 2 = Inline 3 = Loader (1000 Series Only)	1 = Yes 2 = No	1 = Yes 2 = No	1 = 1/4" Hex (up to 100 In-Lb / 8.3 Ft-Lb) 2 = 1/4" Sq. (up to 100 In-Lb / 8.3 Ft-Lb) 3 = 3/8" Sq. (150-500 In-Lb / 12.5-41.7 Ft-Lb) 4 = 1/2" Sq. (1,800-3,000 In-Lb / 150-250 Ft-Lb) 5 = 3/4" Sq. (3,000-12,000 In-Lb / 250-1,000 Ft-Lb) 6 = 1" Sq. (12,000-24,000 In-Lb / 1,000-2,000 Ft-Lb) 7 = 1-1/2" Sq. (24,000+ In-Lb / 2,000+ Ft-Lb)	2 = No
Stationary							
AISI- (in-lb capacities)	2						2
AISF- (ft-lb capacities)	2						2

*Standard range is 10%-100% of maximum capacity. Expanded range is 5%-100% of maximum capacity.

Transducers are available in capacities of up to 10,000 Ft-Lb. Contact an AIMCO Customer Service Associate at 1-503-254-6600, or toll free 1-800-852-1368.

Rundown Fixtures

Torque Measurement: Rundown Fixtures

Features and Benefits

- Enables accurate and repeatable testing of pneumatic or electric power tools
- Mechanical Belleville system of bolt, nut or nut body, Belleville washers and main housing, 1/4" - 3/4" drive sizes, 10 in-lb - 1,200 ft-lb
- Fixtures can be ordered to simulate hard, med., or soft joints



ARDFA-XXXXHD
ARDIA-XXXHD

ARDFA-XXXHDS
ARDIA-XXXHDS

ARDFA-XXXHDE
ARDIA-XXXHDE

ARDFA-XXX
ARDIA-XXX

Wear-Resistant Heavy Duty	X			
Heavy Duty, Fully Encapsulated		X		
Heavy Duty, Encapsulated Washers			X	
Standard (Included w/analyzer)				X
Spline Drive				
Used in Conjunction with External Transducer				
ASTIS	X	X	X	X
AISI / AISF	X	X	X	X
ARTIS	X	X	X	X

*Spline drive feature provides rundown control when testing pulse tools.

AUDITOR RUNDOWN FIXTURES

To test power tools, pneumatic or electric, consistent rotational speed must be achieved. The joint rundown fixture/simulator provides the means by which the tool motor and spindle rotates freely at the start of the test cycle and then develops torque as rotation resistance increases as fastener/joint load increases. The linearity and consistency of the joint rundown fixtures/simulators vary greatly and the tool test data is a product of the variations in these rundown fixtures. Higher quality joint rundown fixtures produce torque data with less scatter.



ARDIA Models

Model*	Recommended Torque Range		Square Drive
	NM	IN-LB	
ARDIA-10(HD)(HDE)(HDS)	.13 - 1.13	1.0 - 10	1/4"
ARDIA-25(HD)(HDE)(HDS)	.28 - 2.8	2.5 - 25	1/4"
ARDIA-50(HD)(HDE)(HDS)	.56 - 5.6	5 - 50	1/4"
ARDIA-100(HD)(HDE)(HDS)	1.3 - 11.3	10 - 100	1/4"
ARDIA-150(HD)(HDE)(HDS)	1.7 - 16.9	15 - 150	1/4"
ARDIA-250(HD)(HDE)(HDS)	2.8 - 28.3	25 - 250	3/8"
ARDIA-350(HD)(HDE)(HDS)	4 - 40	35 - 350	3/8"
ARDIA-500(HD)(HDE)(HDS)	5.6 - 56.5	50 - 500	3/8"
ARDIA-750(HD)(HDE)(HDS)	8.5 - 84.7	75 - 750	3/8"
ARDIA-1000(HD)(HDE)(HDS)	11.3 - 113	100 - 1,000	3/8"

*Add "HD" to part numbers for wear resistant models. Add "HDS" to part numbers for fully encapsulated wear resistant models.

*Add "HDE" to part numbers for partial encapsulated wear resistant models.

ARDFA Models

Model*	Recommended Torque Range		Square Drive
	NM	FT-LB	
ARDFA-100(HD)(HDE)(HDS)	13.6 - 136	10 - 100	1/2"
ARDFA-150(HD)(HDE)(HDS)	20.4 - 204	15 - 150	1/2"
ARDFA-250(HD)(HDE)(HDS)	34 - 340	25 - 250	1/2"
ARDFA-500(HD)(HDE)(HDS)	67.8 - 678	50 - 500	3/4"
ARDFA-600(HD)(HDE)(HDS)	81.6 - 816	60 - 600	3/4"
ARDFA-750(HD)(HDE)(HDS)	101.7 - 1,017	75 - 750	3/4"

* Add "HD" to part numbers for wear resistant models. Add "HDS" to part numbers for encapsulated wear resistant models.

* Add "HDE" to part numbers for partial encapsulated wear resistant models.



Joint Kits / Joint Simulators

JOINT KITS

Joint kits are an essential accessory for accurate off-line testing of powered assembly tools.

- Represent production joint conditions off the production line
- Can be adjusted to include joint conditions specified by ISO 5393
- Allows free running of bolt before torque gradient
- Provide linear response. Repeatable 1/4" - 1" drive sizes, 28 - 1,695 Nm.

AJKR & AJKS Joint Kits

Rotary Kit*	Model	Drive Size - IN
 AJKR	AJKR-28	1/4
	AJKR-135	3/8
	AJKR-271	1/2
	AJKR-1017	3/4
	AJKR-1695	1
Stationary Kit**	Model	Drive Size - IN
 AJKS	AJKS-25D	1/4
	AJKS-38D	3/8
	AJKS-50D	1/2
	AJKS-75D	3/4
	AJKS-100D	1

* AJKR for use with ARTIS external transducers.

**AJKS for use with ASTIS or ARTIS external transducers.

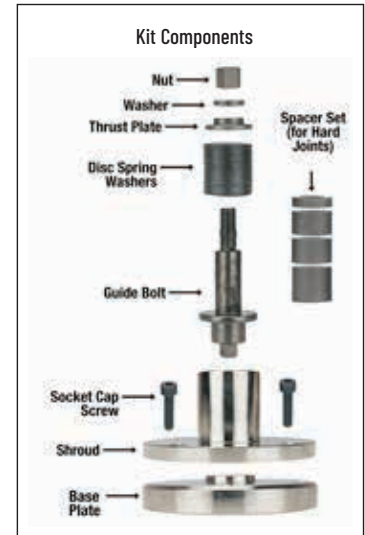

UFT SERIES HYDRAULIC MECHANICAL JOINT SIMULATORS



- Designed for pulse tool and continuous drive tool certification and testing, UFT Joint Simulators offer the most repeatable and linear joint rate simulation on the market
- For use with ARTIS external transducers
- Bolt tightening body and hydraulic pressure loading mechanism are connected by a hydraulic pressure circuit. Ideal for ISO 5393 test procedures
- Quickly and easily simulate three joint rates by opening or closing two external valves
- Specially coated testing bolt produces over 100,000 cycles without variation or deformation

UFT Joint Simulators

Model	Bolt Size	Torque Range		Weight	
		NM	FT-LB	LB	KG
UFT-6	M5	3.2 - 5.4	2 - 4	8	3.6
	M6	5.4 - 14.7	4 - 11		
	M8	14.7 - 31.4	11 - 23		
UFT-10 / UFT-S10	M6	6.7 - 14.7	5 - 11	43	19.5
	M8	14.7 - 31.4	11 - 23		
	M10	31.4 - 53.9	23 - 40		
UFT-16 / UFT-S16	M12	53.9 - 88.2	40 - 65	88	40
	M14	88.2 - 149	65 - 110		
	M16	149 - 190	110 - 140		
UFT-24*	M18	190 - 294	140 - 217	108	49.1
	M20	294 - 441	217 - 325		
	M24	441 - 686	325 - 506		

* UFT-24 medium hard/soft joints only
Reaction fixture for continuous drive tools not included. Sockets included.

Torque Measurement Cables



ICBL-USB



ATDBLIS



ATDBRIS



ICBL-10P



ICBL-4P



ICBL-5000L



ICBL-8000DIG

Torque Measurement Cables

Model	Description	Serial Cable	Transducer Cable	Rotary	Rotary W/Angle	Stationary	Ind Std	Intellect
ICBL-USB*	Connects between COM port of display to PC	X						
ATDBLIS*	Connect to IS transducer w/ angle - 10 pin		X		X		X	
ATDBRIS*	Connect to IS transducer - 4 pin		X	X		X	X	
ICBL-10P*	Intellect transducer cable. Identification chip in cable - 10 pin connector		X		X			X
ICBL-4P*	Intellect transducer cable. Identification chip in cable - 4 pin connector		X	X		X		X
ICBL-5000L	Connect from AUET/MTM & ATDA to Intellect Transducers, Analog AISI / AISF		X			X		X
ICBL-8000DIG	Connect PC to digital transducers through digital module		X					

* Compatible with ATDA, AUET products

Tester / Analyzer Compatibility

Model	ATC	AUET	AUET/MTM	AUET-DC	AUET/MTM-DC	ATDA	ATDA-DC	AISWT Switchbox	AIMTS Test Stand
ICBL-USB	X	X	X	X	X	X	X		
ATDBLIS		X	X	X	X	X	X		
ATDBRIS		X	X	X	X	X	X		
ICBL-10P		X	X	X	X	X	X		
ICBL-4P		X	X	X	X	X	X		
ICBL-5000L			X		X	X	X	X	X
ICBL-8000DIG									X

Transducer Compatibility

Model	Stationary			Rotary
	ASTIS	Analog AISI/AISF	Digital AISI/AISF	ARTIS
ATDBLIS				X
ATDBRIS	X			X
ICBL-10P				X
ICBL-4P				X
ICBL-5000L		X		
ICBL-8000DIG			X	



Index

MODEL #	PAGE	MODEL #	PAGE	MODEL #	PAGE	MODEL #	PAGE	MODEL #	PAGE
A		APTH-120E15	20	APTW-150	20	ATC-500	9	C	
AHCTS-0.5K	16	APTH-120E16	20	APTW-200	20	ATC-500F	9	CA150108DHD	15
AHCTS-1.5RDF	15	APTH-120E17	20	APTW-340	20	ATC-750	9	CA1510	15
AHCTS-001K	16	APTH-120E18	20	ARDFA-100(HD)(HDE)(HDS)	26	ATC-750F	9	CA1550	15
AHCTS-1RDF	15	APTH-120E19	20	ARDFA-150(HD)(HDE)(HDS)	26	ATC-1000	9	CA1575	15
AHCTS-2.5K	16	APTH-120E20	20	ARDFA-250(HD)(HDE)(HDS)	26	ATC-1800	9	CA2510I	15
AHCTS-3/4RDF	15	APTH-120E50	20	ARDFA-500(HD)(HDE)(HDS)	26	ATDA	12	CA2515I	15
AHCTS-005K	16	APTH-12RE50	20	ARDFA-600(HD)(HDE)(HDS)	26	ATDA-DC	12	CA2575I	15
AHCTS-010K	16	APTH-12RT25	20	ARDFA-750(HD)(HDE)(HDS)	26	ATDBLIS	28	I	
AHCTS-025K	16	APTH-12RT38	20	ARDIA-10(HD)(HDE)(HDS)	26	ATDBRIS	28	ICBL-4P	28
AHCTS-0500	16	APTH-12RT50	20	ARDIA-25(HD)(HDE)(HDS)	26	ATW-0100F	21	ICBL-10P	28
AHCTS-2500	16	APTH-12SD25	20	ARDIA-50(HD)(HDE)(HDS)	26	ATW-0200F	21	ICBL-5000L	28
AHCTS-5000	16	APTH-12SD38	20	ARDIA-100(HD)(HDE)(HDS)	26	ATW-0500F	21	ICBL-8000DIG	28
AHCTS-7500	16	APTH-12SD50	20	ARDIA-150(HD)(HDE)(HDS)	26	ATW-1000F	21	ICBL-USB	28
AHDTS-5025	16	APTH-14ADP	20	ARDIA-250(HD)(HDE)(HDS)	26	ATWL-250	19	iTVC	23
AIMTS Test Stands	18	APTH-14BLANK	20	ARDIA-350(HD)(HDE)(HDS)	26	ATWL-750	19	P	
AISF-200100	25	APTH-140E1	20	ARDIA-500(HD)(HDE)(HDS)	26	ATWL-1000	19	Phoenix III Digital Torque Wrenches	22
AISF-200250	25	APTH-140E13	20	ARDIA-750(HD)(HDE)(HDS)	26	Audit Manager Software	14	S	
AISF-201000	25	APTH-140E14	20	ARDIA-1000(HD)(HDE)(HDS)	26	AUET-10(-DC)	10	SMD Tools Software	14
AISI-200025	25	APTH-140E15	20	ARTIS-25H-2T(A)	24	AUET-50(-DC)	10	T	
AISI-200100	25	APTH-140E16	20	ARTIS-25H-5T(A)	24	AUET-0100(-DC)	10	Tool Manager Software	13
AISI-200500	25	APTH-140E17	20	ARTIS-25H-20T(A)	24	AUET-250(-DC)	10	U	
AISWT-4L	8	APTH-140E18	20	ARTIS-25S-10T(A)	24	AUET-500(-DC)	10	UFT-6	27
AISWT-6L	8	APTH-140E19	20	ARTIS-38S-75T(A)	24	AUET-1000(-DC)	10	UFT-10	27
AJKR-28	27	APTH-140E21	20	ARTIS-50S-180T(A)	24	AUET-1200(-DC)	10	UFT-16	27
AJKR-135	27	APTH-140E22	20	ARTIS-75S-250T(A)	24	AUET-1800(-DC)	10	UFT-24	27
AJKR-271	27	APTH-140E24	20	ARTIS-75S-500T(A)	24	AUET/MTM-10-100	10	UFT-24	27
AJKR-1017	27	APTH-140E25	20	ARTIS-100S-1400T(A)	24	AUET/MTM-050-25	10	UFT-510	27
AJKR-1695	27	APTH-140E27	20	ARTIS-25H-10T(A)	24	AUET/MTM-50-250	10	UFT-S16	27
AJKS-25D	27	APTH-140E30	20	ARTIS-25S-20T(A)	24	AUET/MTM-50-500(-DC)	10		
AJKS-38D	27	APTH-140E32	20	ARTIS-38S-25T(A)	24	AUET/MTM-050-600	10		
AJKS-50D	27	APTH-140E34	20	ARTIS-100S-750T(A)	24	AUET/MTM-50-1000(-DC)	10		
AJKS-75D	27	APTH-140E36	20	ASTIS-25D-11	25	AUET/MTM-0100-050	10		
AJKS-100D	27	APTH-140E38	20	ASTIS-25D-28	25	AUET/MTM-100-500	10		
APTH-12ADP	20	APTH-140E41	20	ASTIS-38D-135	25	AUET/MTM-100-1000	10		
APTH-12BLANK	20	APTH-140E118	20	ASTIS-50D-270	25	AUET/MTM-100-1200	10		
APTH-120E7	20	APTH-140E138	20	ASTIS-75D-1000	25	AUET/MTM-100-1600(-DC)	10		
APTH-120E8	20	APTH-14RE32	20	ASTIS-100D-1700	25	AUET/MTM-100-2000	10		
APTH-120E9	20	APTH-14RT34	20	ATC-10	9	AUET/MTM-250-1600	10		
APTH-120E10	20	APTH-14RT50	20	ATC-25	9	AUET/MTM-250-1800	10		
APTH-120E11	20	APTH-14SD50	20	ATC-100	9	AUET/MTM-250-2500	10		
APTH-120E12	20	APTW-25	20	ATC-150F	9	AUET/MTM-500-1200	10		
APTH-120E13	20	APTW-50	20	ATC-250	9	AUET/MTM-500-2500(-DC)	10		
APTH-120E14	20	APTW-100	20	ATC-250F	9				



PRINTED IN THE U.S.A.

LIT-TM290, REV 05-29-24, ©2024 AIMCO

AIMCO CORPORATE HEADQUARTERS

10000 SE Pine Street
Portland, Oregon 97216
Phone: (503) 254-6600
Toll Free: 1-800-852-1368

AIMCO CORPORATION DE MEXICO SA DE CV

Ave. Cristobal Colon 14529
Chihuahua, Chihuahua. 31125
Phone: (01-614) 380-1010
Fax: (01-614) 380-1019