

AUDITOR

Torque Measurement Solutions

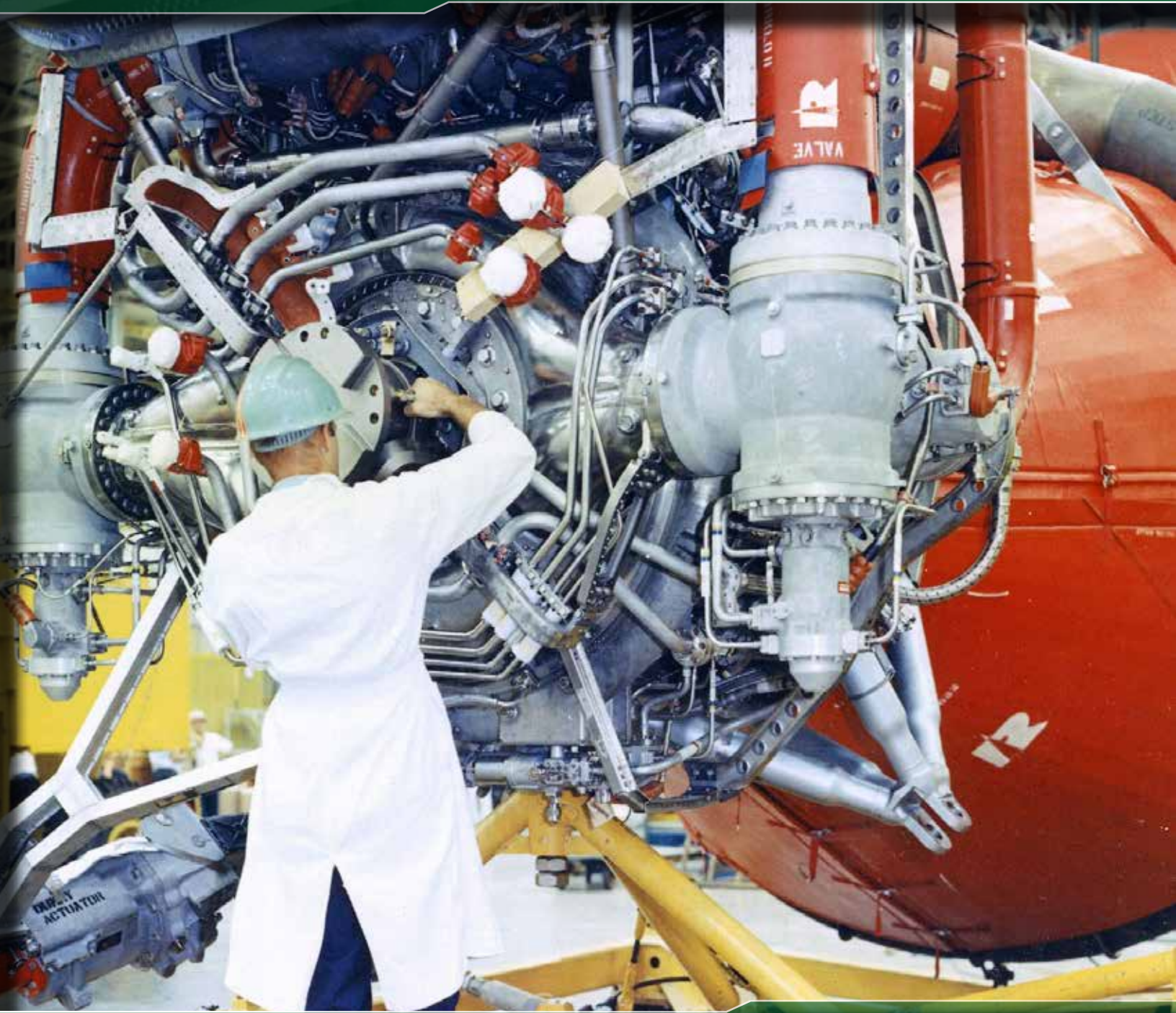

Tightening and Verifying Assembly is Mission Critical



For over 40 years AIMCO has been working with manufacturers around the world, we are the complete global source for all assembly, fastening, and critical bolting needs. AIMCO can effectively and swiftly meet your needs whether you're in Thailand fastening a 3 mm nut at 3 Nm, or in Tennessee, USA torquing the last lug nut. AIMCO provides the tools and solutions, on a global scale, that guarantee the success of your project. It is with great pride that AIMCO can say the products that we manufacture are **MADE IN THE USA.**

ISO 9001: 2015 Certified

TABLE OF CONTENTS

AUDITOR™ TORQUE MEASUREMENT SOLUTIONS

TORQUE MEASUREMENT: OVERVIEW4
TORQUE MEASUREMENT: SYSTEMS.7
TORQUE MEASUREMENT TESTERS8
TORQUE MEASUREMENT ANALYZERS	12
TOOL MANAGER / AUDIT MANAGER	18
HIGH-CAPACITY TEST STANDS.	19
TORQUE WRENCHES	22
TORQUE CARTS	30
DATA COLLECTION SOFTWARE.	32
TRANSDUCERS	34
RUNDOWN FIXTURES / JOINT SIMULATORS.	36
TORQUE MEASUREMENT CABLES.	39
APPENDICES	40
INDEX.	44



TORQUE MEASUREMENT: OVERVIEW

TORQUE MEASUREMENT AND THE VERIFICATION OF TORQUE TOOLS AND APPLIED TORQUE ARE AN INTEGRAL PART OF TODAY'S THREADED ASSEMBLY PROCESS. The method used to measure torque can affect the judgments made regarding tool performance, assembly processes and overall product quality.

DYNAMIC TORQUE

The torque produced during the actual tightening process, normally measured using rotary transducers and a torque analyzer.

Advantages:

- Reduces operator influence.
- Measures applied torque.
- Can also include angle of rotation as error proofing parameter.

RESIDUAL TORQUE

The torque measured by producing an incremental amount of movement of the fastener after the actual tightening process, normally measured using a dial or digital torque wrench.

Advantages:

- Easy access to fastener.
- Error proofing.
- Can detect missed fasteners or joints with significant relaxation.

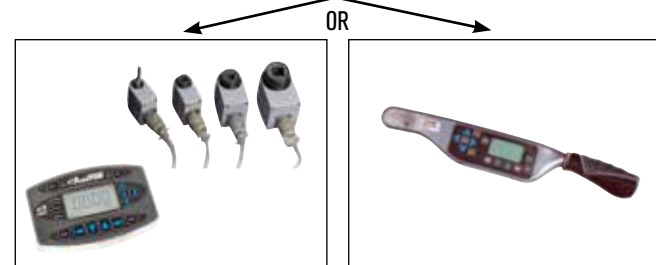
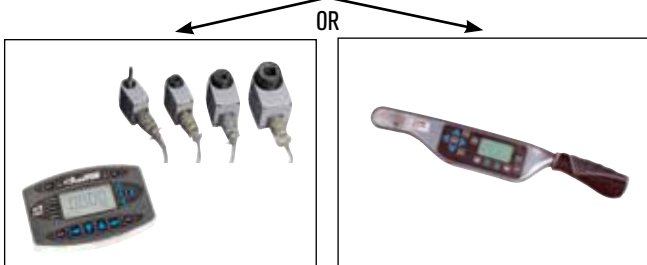
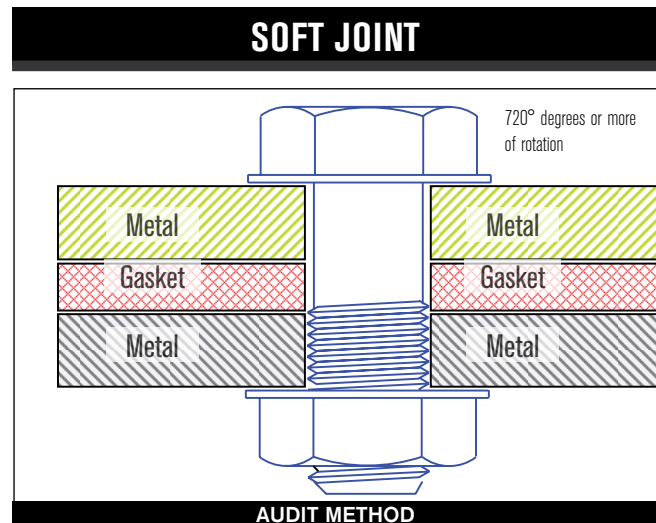
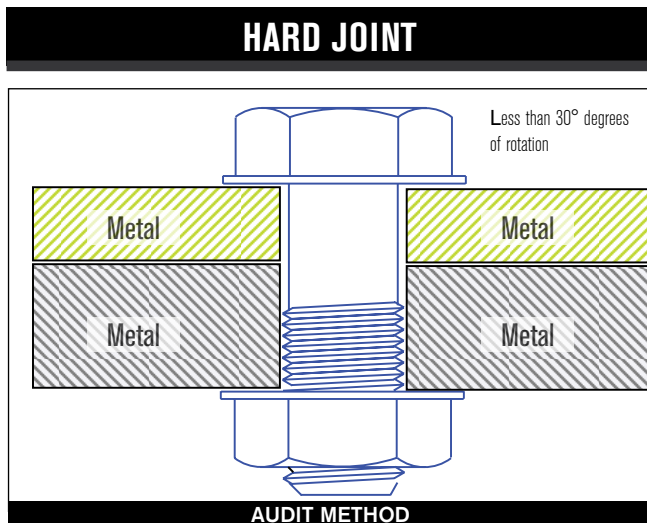

Dynamic Torque: 15 Nm

Residual Torque: 18 Nm

Dynamic Torque: 15 Nm

Residual Torque: 12 Nm

Values as examples only

Values as examples only

A hard joint, one requiring a low degree of rotation during tightening, will normally show very little relaxation after tightening. Due to the high amount of remaining clamp load and friction within the joint members, additional movement of the fastener requires additional torque energy to be applied. Therefore, Residual Torque values will be higher than Dynamic Torque values.

A soft joint, one requiring a high degree of rotation during tightening, will normally show significant amounts of relaxation after tightening. Relaxation leads to a loss of clamp load and friction within the joint members. Due to this relaxation, additional movement of the fastener requires relatively small amounts of additional torque energy and Residual Torque values will be lower than Dynamic Torque values.

TORQUE MEASUREMENT: OVERVIEW

CHECKING TORQUE MEASUREMENT BEFORE, DURING, AND AFTER ASSEMBLY ENSURES QUALITY MANUFACTURING. Proper torque measurement is critical in many assembly operations. AIMCO utilizes years of experience to design a process around your specific auditing requirements. From simple dial wrenches to electronic data collectors and joint analyzers for R&D, AIMCO is with you every step of the way.

BEFORE ASSEMBLY – TOOL CAPABILITY

Is the tool working correctly?

Testing and verifying tools under controlled conditions. Identify the accuracy & repeatability of the tool before using it in production.

Equipment used:

- Desktop testers with internal transducers.
- Auditor™ analyzers with either stationary or rotary transducers.
- UFT hydraulic joint simulators and rotary transducers.

PRODUCTS TO USE...



DURING ASSEMBLY – PROCESS CAPABILITY

How does the tool work with the product being assembled?

Testing the tools during the actual process helps ensure that the process is working correctly. This is where variables in the parts and influences from the operator can be accounted for.

Equipment used:

- Torque Data Collectors/Analyzers
- Auditor™ Rotary Transducers



AFTER ASSEMBLY – PRODUCT CAPABILITY

Does the finished product meet the user's expectations?

Checking the product after assembly is the final opportunity to check the product prior to user delivery. This is the way to verify that product quality is satisfactory.

Equipment used:

- Click/Dial wrenches
- Electronic wrenches with Auditor™ analyzers.
- Rotary transducers and Auditor™ analyzers with hand driver to move fastener.



TORQUE MEASUREMENT: OVERVIEW

MEASURING QUALITY – PROCESS CAPABILITY

STATISTICAL ANALYSIS IS AN IMPORTANT STEP IN ANY QUALITY CONTROL PROCESS.

One of the most widely accepted statistical indicators of process quality, and therefore product quality, is Cpk, or the process capability for a centered process. This value indicates how capable a process is and whether the results of that process are properly centered near a specific target. A capable process is one that approaches, as a limit, 100% conformance to specifications.

Cpk is a statistical value that indicates how tightly grouped a series of samples is around the target value. Cpk is a function of the Upper Specification Limit (USL), the Lower Specification Limit (LSL), the mean of the samples and the standard deviation (σ) of the samples.

$$Cpk = \text{either } \frac{(USL - \text{Mean})}{(3 \times \sigma)} \text{ or } \frac{(\text{Mean} - LSL)}{(3 \times \sigma)}, \text{ whichever is smaller.}$$

An acceptable, or capable, process will normally have a Cpk value of at least 1.33.

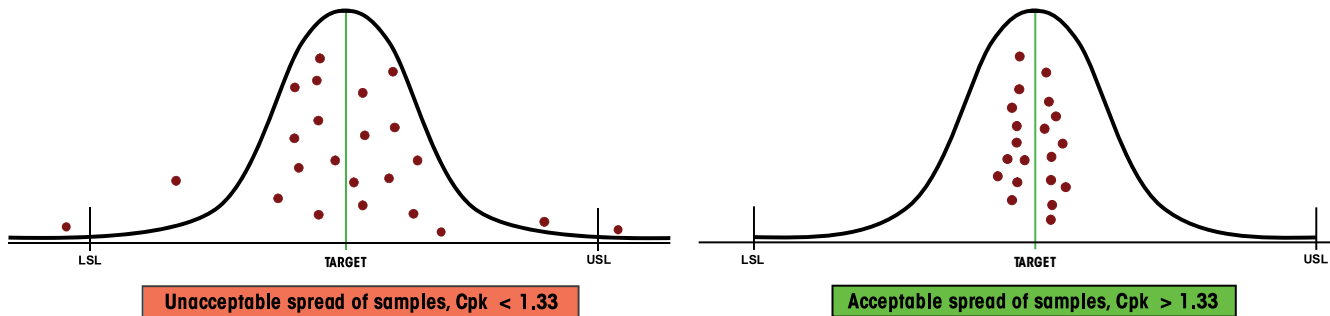

MEASURING QUALITY – CLAMP LOAD

THE PURPOSE OF THREADED FASTENING IS TO PRODUCE THE CORRECT AMOUNT OF CLAMP LOAD WITHIN THE JOINT.

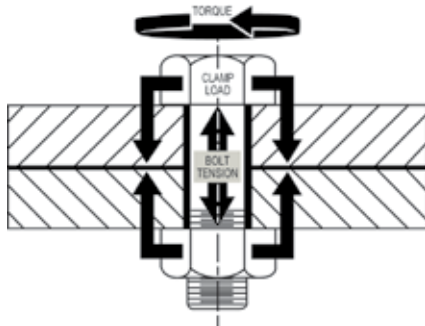

Due to the cost and difficulty of measuring clamp load during the actual assembly process, torque is used as the control parameter during tightening. Many manufacturers use torque values as the primary indicator of threaded assembly quality. However, achieving repeatable clamp load is a better indicator of joint quality.

Studies have shown that discontinuous drive tools can produce equal or better clamp load results when compared to continuous drive tools.

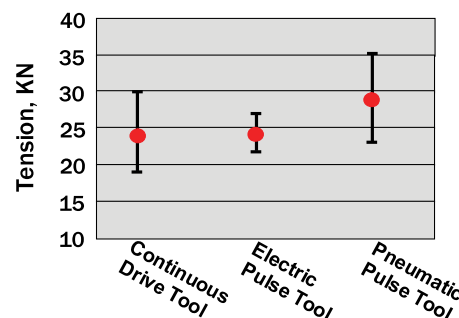
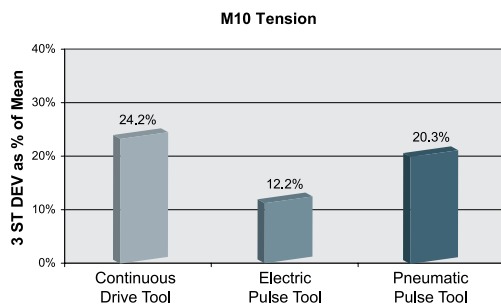

TORQUE MEASUREMENT SYSTEMS



TORQUE MEASUREMENT SYSTEMS										
Devices	Model Series	Data Collector	Integrated Transducer	Torque Wrench	Torque Wrench Loader	External Transducer Port	Stationary Transducers -Smart	Stationary Transducers -Ind Std	Rotary Transducer -Smart	Rotary Transducer - Ind Std
Tester	ATC		X							
	AUET		X							
	AUET-DC	X	X							
	AUET/MTM		X			X				
	AUET/MTM-DC	X	X			X				
Analyzer	ATDA					X				
	ATDA-DC	X				X				
	ATDA-8000 -10-DCA(-TA)(-TP)	X				X				
	ADET	X				X				
	DataTouch3	X				X				
Wrench	ADW			X						
	ADW-DC	X								
	APTW			X						
	ATW			X						
	ATWL				X					
	FRDM3	X		X						
	FWE			X						
Transducer	ARTIS									X
	ASTIS							X		
	AISI						X			
	AISF						X			
	AIRI								X	
	AIRF								X	
	ARTB (Bluetooth)									X
	ASTB (Bluetooth)								X	
Rundown Fixtures	AJKR									
	AJKS									
	ARDFA									
	ARDIA									
	ARDA (Spline Drive)									
Joint Simulator	UFT									
Test Stands	AHCTS*	X*	X*	X*			X*	X*	X*	X*
	AHCTS-K*	X*	X*	X*			X*	X*	X*	X*
	AHDTS*	X*	X*	X*			X*	X*	X*	X*
	AHBTS*	X*	X*	X*			X*	X*	X*	X*
	AIMTS*	X*	X*	X*			X*	X*	X*	X*
Torque Cart	iTVC*	X*	X*	X*			X*	X*	X*	X*
	FTY*									
	MSB*	X*	X*	X*			X*	X*	X*	X*

*configured to customer specifications





TORQUE MEASUREMENT TESTERS

TORQUE MEASUREMENT: TESTERS

Features and Benefits

- Heavy Industrial Design
- All Software included
- Auditor Torque Testers are designed for intuitive and functional usability. AUET/MTM models are available with our unique dual integrated torque transducer package.

Testers are designed to audit torque wrenches and power tools, including pulse tools

					
	ATC	AUET	AUET/MTM	AUET-DC	AUET/MTM-DC
Auditor Torque Cube		Auditor Universal Electronic Tester	Auditor Universal Electronic Tester - Multiple Transducer Module	Auditor Universal Electronic Tester - Data Collector	Auditor Universal Electronic Tester - Multiple transducer Module - Data Collector
	Compact vertical or horizontal bench-mount tester.	Bench mount or line side tester utilizing integrated transducer.	Bench mount or line side tester with dual integrated transducer and external transducer capacity.	Bench mount or line side tester utilizing integrated transducer. Provides data collection capability with included software to interface with PC.	Bench mount or line side tester with dual integrated transducer and external transducer capacity. Provides data collection capability with included software to interface with PC.
Integrated Transducer Range (values are in full scale)	100 in/oz - 1,000 ft/lbs 1 - 1,350 Nm	100 in/oz - 750 ft/lbs 1 - 1,000 Nm	100 in/oz - 750 ft/lbs 1 - 1,000 Nm	100 in/Oz - 750 ft/lbs 1 - 1,000 Nm	100 in/oz - 750 ft/lbs 1 - 1,000 Nm
External Transducer Capacity (transducer sizes exceeding this range may be special ordered)			up to 5,000 ft-lbs		up to 5,000 ft-lbs
Vertical / Horizontal Mount	X				
Bi-directional accuracy of +/- X of indicated reading within the top 90% of the Tester's capacity	1%	0.50%	0.50%	0.50%	0.50%
Data Output to PC	X	X	X	X	X
Integrated Torque Transducer	1	1	2	1	2
External Transducer Port			X		X
Number of stored readings	999	999	999	999	999
Adjustable rundown fixture included *	1	1	2	1	2
Rechargeable NiMH Battery	X	X	X	X	X
Measurement Modes					
Peak	X	X	X	X	X
First Peak (Click)	X	X	X	X	X
Pulse	X	X	X	X	X
Track	X	X	X	X	X
Units of Measure Options	8	8	8	8	8
Tool Manager Software Included				X	X

* Included with all testers and analyzers with a range up to 1000 in/lbs.

TORQUE MEASUREMENT TESTERS USED IN CONJUNCTION WITH

External Transducers					
ASTIS - Stationary			X		X
ARTIS - Rotary			X		X
Switch box for External Transducer					
AISWT-4L > 4 Way Intellect box			X		X
AISWT-6L > 6 Way Intellect box			X		X
Cables					
ICBL-USB - USB Serial > PC	X	X	X	X	X
ATDBLIS - IS Transducer w/angle (10 Pin)			X		X
ATDBRIS - IS Transducer (4 Pin)			X		X
ICBL-10P - Intellect transducer cable Identification chip in cable - 10 pin connector			X		X
ICBL-4P - Intellect transducer cable. Identification chip in cable - 4 pin connector			X		X

AUDITOR™ TORQUE CUBE™



ATC-10
ATC-25
ATC-100
ATC-250
ATC-500



ATC-150F
ATC-250F
ATC-750F



AUDITOR™ TORQUE CUBE™

The Auditor Torque Cube (ATC) is a compact, versatile desktop tester and provides a multitude of capabilities. The ATC is designed to test hand or power tools with the following:

- Peak, first peak and track modes.
- Multiple engineering units.
- Manual and auto clear function.
- Multiple frequency response settings.
- Bi-directional use and accuracy.
- Accuracy is better than 1% of indicated reading top 90% of range.
- Serial data output.
- Memory 999 data samples.
- Battery and/or mains powered.

Because precision and quality are critical, you can depend on our testers to calibrate and certify your tools. Whether you are assembling large complicated systems or small precise time pieces, AIMCO provides the best system for your application. Our instruments have been judged “best in class” by independent National Standards laboratories. Auditor Torque Cube is rugged enough to test and verify tools at “point of use” while still being accurate enough to calibrate hand and power tools.

Each tester is shipped with a mains/battery charger power cord, a hex to allen drive bit, and a bolting template. Models with max torque of 1,000 ft-lb or less also include a joint rundown fixture. The ATC can be positioned vertically or horizontally for the ergonomic testing of inline or pistol grip tools.

MODEL	RECOMMENDED TORQUE RANGE		WEIGHT		W X H X D		SQUARE DRIVE
	Nm	in-lb/ft-lb	kg	lb	mm	in	
Vertical Configuration							
ATC-10	0.13 - 1.13	1 - 10	1.13	2.5	79 x 95 x 83	3.13 x 3.75 x 3.25	1/4
ATC-25	0.28 - 2.83	2.5 - 25	1.13	2.5	79 x 95 x 83	3.13 x 3.75 x 3.25	1/4
ATC-100	1.13 - 11.3	10 - 100	1.13	2.5	79 x 95 x 83	3.13 x 3.75 x 3.25	1/4
ATC-250	2.83 - 28.3	25 - 250	1.13	2.5	79 x 95 x 83	3.13 x 3.75 x 3.25	3/8
ATC-500	5.65 - 56.5	50 - 500	1.13	2.5	79 x 95 x 83	3.13 x 3.75 x 3.25	3/8
Horizontal Configuration							
ATC-150F	20 - 200	15 - 150 ft-lb	2.25	5	79 x 95 x 83	3.13 x 3.75 x 3.25	1/2
ATC-250F	34 - 340	25 - 250 ft-lb	2.25	5	79 x 95 x 83	3.13 x 3.75 x 3.25	1/2
ATC-750F	101.7 - 1017	75 - 750 ft-lb	2.25	5	79 x 95 x 83	3.13 x 3.75 x 3.25	3/4

AUDITOR™ BENCH MOUNT TESTERS



AUET



AUET/MTM



AUET/MTM-DC

AUDITOR™ UNIVERSAL ELECTRONIC TESTERS

The Auditor Universal Electronic Testers (AUET) have a broad range of features to accommodate most requirements. These instruments are designed to be bench-top mounted and are available in several configurations and various single or multiple torque ranges. Onboard memory allows you to capture 999 torque event readings. The testers are also available in file capability (DC) models. The DC models require PC software Auditor Tool Manager (ATM).

units are supplied with an external transducer port and selector switch for connecting additional transducers.

These AUET instruments utilize the same transducers that are featured in the ATC instruments, providing the same high quality accuracy and durability. The common interface makes the Auditor tester extremely user friendly.

Instruments up to 1,000 in-lb are supplied with rundown adapters/joint kits. Rundown kits for larger instruments can be ordered separately. AUET/MTM



SINGLE TRANSDUCER MODELS

MODEL**	RECOMMENDED TORQUE RANGE	
	In-oz/In-lb	kgf-cm/Nm
AUET-0100(-DC)	10 - 100 in-oz	0.7 - 7.2 kgf-cm
AUET-10(-DC)	1 - 10 in-lb	1.1 - 11.5 kgf-cm
AUET-50(-DC)	5 - 50 in-lb	0.5 - 5.6 Nm
AUET-100(-DC)	10 - 100 in-lb	1.1 - 11.3 Nm
AUET-250(-DC)	25 - 250 in-lb	2.8 - 28.3 Nm
AUET-500(-DC)	50 - 500 in-lb	5.7 - 56.5 Nm
AUET-1000(-DC)	100 - 1,000 in-lb	11.3 - 113 Nm
AUET-1200(-DC)	120 - 1,200 in-lb	13.6 - 135.6 Nm

DUAL TRANSDUCER MODELS

MODEL**	RECOMMENDED TORQUE RANGE			
	Transducer 1	Transducer 2	Transducer 1	Transducer 2
AUET/MTM-10-100(-DC)	1.0 - 10 in-lb	10 - 100 in-lb	0.11 - 1.12 Nm	1.3 - 11.3 Nm
AUET/MTM-50-250(-DC)	5.0 - 50 in-lb	25 - 250 in-lb	0.56 - 5.65 Nm	2.8 - 28.3 Nm
AUET/MTM-50-500(-DC)	5.0 - 50 in-lb	50 - 500 in-lb	0.56 - 5.65 Nm	5.65 - 56.5 Nm
AUET/MTM-100-500(-DC)	10 - 100 in-lb	50 - 500 in-lb	1.13 - 11.3 Nm	5.65 - 56.5 Nm
AUET/MTM-100-1000(-DC)	10 - 100 in-lb	100 - 1,000 in-lb	1.13 - 11.3 Nm	11.3 - 113 Nm

*Custom sizes are also available, please inquire. **Add "-DC" to part numbers for data collecting models.

Data collecting models allow multiple files/tools/applications to be associated with torque data. Requires Tool Manager software.

AUDITOR™ TORQUE MEASUREMENT ANALYZERS

TORQUE MEASUREMENT: ANALYZER

Features and Benefits

- Auditor Torque Analyzers share similar features across all products and are designed for intuitive and functional usability.
- Connects to AIMCO's line of rotary and stationary transducers



ATDA

ATDA-DC

Auditor Torque Data Analyzer

Auditor Torque Data Analyzer with Data Collection

Portable analyzer to be connected to various transducers

Portable analyzer to be connected to various transducers. Provides data collection capability with included software to interface with PC

Bi-directional	X	X
Data Output to PC	X	X
External Transducer Port	1	1
Number of stored readings	999	999
Rechargeable NiMH Battery	X	X
Digital I/O for external devices	X	X
<u>Measurement Modes</u>	X	X
Peak	X	X
First Peak (Click)	X	X
Pulse	X	X
Track	X	X
Measurement Units	8	8
<u>Software Included</u>		X
Firmware		
LAB - Line Side Auditing		
SPC - Quality Control		
Barcode Reader	X	X
Bluetooth Wireless Option		

USED IN CONJUNCTION WITH

Transducers

AISI / AISF - Digital		
ASTIS - Stationary	X	X
ASTB - Stationary Wireless		
ARTIS - Rotary	X	X
ARTIS2 - Rotary		
ARTB - Rotary Wireless		

Wrenches

ATW	X	X
FWE		





Switch boxes for External Transducers

AISWT-4L > 4 Way Intellect box	X	X
AISWT-6L > 6 Way Intellect box	X	X

Cables

ICBL-USB - USB Serial > PC	X	X
ATDBLIS - IS Transducer w/ angle (10 Pin)	X	X
ATDBRIS - IS Transducer (4 Pin)	X	X
ICBL-10P - Intellect transducer cable. Identification chip in cable - 10 pin connector	X	X
ICBL-4P - Intellect transducer cable. Identification chip in cable - 4 pin connector	X	X
ICBL-8000DIG - Connect from ATDA-8000 series analyzer to AISI / AIFI transducer		
RMC Cable DT.ET		
FWE Cable DT.ET		

AUDITOR™ TORQUE MEASUREMENT ANALYZERS

			
ATDA-8000	ATDA-8000-10-DCA(-TA)(-TP)	ADET	DataTouch3
Auditor Torque Data Analyzer with 7" screen	Auditor Torque Data Analyzer -10" display with Data Collection. TA = Torque & Angle, TP = Torque & Pressure	Auditor Torque Data Analyzer with Data Collection	Torque and Angle Data Collector designed to operate with SQnet software
7" screen with high resolution display and intuitive user interface	10" touch screen with high resolution display and intuitive user interface with multiplexer	Portable with 2.8" touchscreen that displays graphical data with zoom/plot features. 1 GB memory	Portable with 2.8" touchscreen that displays graphical data with zoom/plot features. 1 GB memory
X	X	X	X
X	X	X	X
4	4	1	1
999	999	20,000	20,000
X	X	X	X
X	X	X	X
X	X	X	X
X	X	X	X
X	X	X	X
X	X	X	X
X	X	X	X
X	X	X	X
8	8	8	8
X	X	X	X
		X	X
			X
X	X		
		X	
			X
		X	X
			X
X	X		
		X	X
		X	X

AUDITOR™ TORQUE DATA ANALYZERS



ATDA-DC

AUDITOR™ TORQUE DATA ANALYZERS

The Auditor Torque Data Analyzer (ATDA) DC is designed to be portable or conveniently placed on a bench. Depending on requirements, the tester can be connected to various transducers. In addition, it can be connected to transducerized wrenches and rotary or stationary transducers. The user interface is common between the ATC (Cube), AUET, AUET-DC, AUET/MTM, AUET/MTM-DC, ATDA, and ATDA-DC. All of these instruments have similar menus. Additionally, all data collector testers utilize Auditor Tool Manager for tool testing and data management.

The Auditor Torque Data Analyzer is available in two configurations:

- ATDA: A simple torque analyzer with sequential memory, 999 data samples, engineering limits, limited statistical processing average, range, Cp and CpK with serial output.
- ATDA-DC: Contains all of the features of the ATDA and has additional file capability. It can associate data with file names and manage data collection with a computer and Auditor Tool Manager software.



This is a great “starter” tool management system. It provides testing, archiving, and analysis of tools at single or multiple torque targets. The tool and torque data is stored in a SQL database and can be exported to Excel or any .csv spreadsheet.

MODEL	DESCRIPTION
ATDA	Auditor Torque Data Analyzer
ATDA-DC	Auditor Torque Data Collector

AUDITOR™ TORQUE DATA ANALYZERS



ATDA-8000

ATDA-8000-10-DCA(-TA)(-TP)

TOUCH SCREEN AUDITOR™ TORQUE DATA ANALYZERS

Auditor offers the ATDA-8000 and the ATDA-8000-10-DCA(-TA)(-TP). The ATDA-8000 is a touch screen instrument with a high resolution display and user interface that facilitates “point of use” tool validation. The user interface is intuitive and the display provides clear easy to read data. Features and parameter settings are password protected to ensure parameters cannot be inadvertently changed. After initial setup, the instrument provides semi-automatic tool validation and judgment.

The ATDA-8000 is a single channel instrument. The ATDA-8000-10-DCA(-TA)(-TP) is a larger instrument that includes a multiplexor for connection to multiple transducers allowing a wide range of tools to be tested with one instrument. The (-TA) model is designed for torque and angle analysis and the (-TP) model is designed for torque and pressure analysis.

Both the ADTA-8000 and the ATDA-8000-10-DCA(-TA)(-TP) systems work with AIMCO’s line of digital transducers.

MODEL	DESCRIPTION
ATDA-8000	Auditor Torque Analyzer Single channel 7" touch screen point of use validation system
ATDA-8000-10-DCA(-TA)(-TP)	Auditor Torque Analyzer Multiple transducer 10" touch screen point of use validation system



AUDITOR™ TORQUE DATA ANALYZER

Auditor Data Analyzer provides a simple way to monitor nutrunners and torque wrenches on the assembly line. This quick, simple data collector provides an economical alternative to the DataTouch Data Analyzer.

Features and Benefits

- Full-color touchscreen for easy navigation.
- Graphical display with zoom/plot features for inspecting charts and graphs on the analyzer.
- Transducer auto-recognition reduces set-up time.
- Bluetooth wireless (Advanced).
- Embedded LAB firmware makes it easy to create quality tool strategies.
- Simple transfer of data to PC using F3 Explorer software for data storage.
- 1 GB memory stores multiple test strategies and data.
- Li-Ion battery with 8 hour life.
- Available in two versions:
 - Basic - ADET
 - Advanced - ADETB
- Advanced version connects with wireless transducers and printers, then exports data using system software.

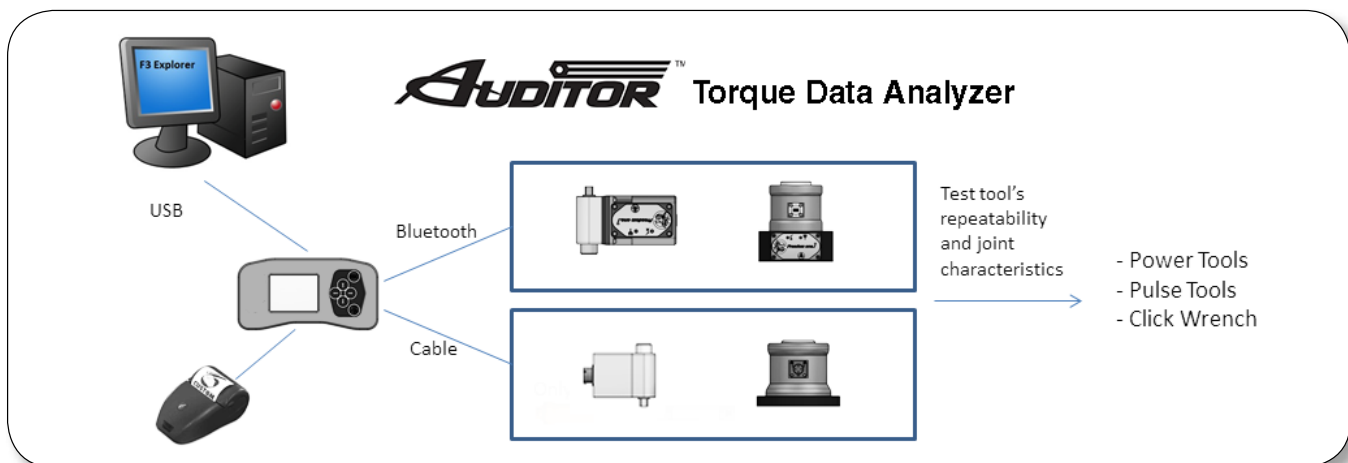

Specifications

Internal Memory: 1 GB
20,000 results, 20,000 curves,
1,000 programs

High-resolution 2.3" touchscreen, 320 x 240 pixels,
65,535 colors



DATATOUGH3 DATA ANALYZER

DataTouch3 is a torque/angle data collector designed to operate with SQnet software. Test tightening tools by connecting stationary or rotary transducers. Test joints by connecting the FWE Wrench.



DataTouch3

Features and Benefits

- Full-color touchscreen for easy navigation.
- Graphical display with zoom/plot features for inspecting charts and graphs on the wrench.
- Transducer auto-recognition reduces set-up time.
- WiFi and Bluetooth options for cableless communication with transducer and laptop.
- Keyboard for navigation and switching on/off.
- Program advanced tightening strategies with easy input steps.
- Embedded firmware (LAB and SPC) targets quality functions.
- 1 GB memory enables storage of all test parameters, results, and curves.
- Li-Ion battery with 8-hour life.
- Optional bar code reader for data traceability.

SQnet software provides protection protocols and allows user to define routes linked to location and tool ID. User downloads events to wrench, performs tasks and sends results back that can be graphed or charted so that statistics can be analyzed.



Specifications

Internal Memory: 1 GB
20,000 results, 20,000 curves,
1,000 settable programs

High-resolution 2.8" touchscreen,
320 x 240 pixels, 65,535 colors

Dimensions

Length	215 mm
Width	144 mm (with battery cap)
Depth	63 mm
Weight	750 g + 90 g (belt)



Battery

Power Supply

- Li-Ion changeable battery
3.6 V, 2700 mA
- 9 hours battery life
- 6 hours to recharge
battery by PC USB port
- 4 hours to recharge
battery using external
battery charger (optional)

AUDITOR™ TOOL MANAGER/AUDIT MANAGER

AUDITOR™ TOOL MANAGER SOFTWARE

Tool Manager Software is included with the purchase of AUET-DC and AUET/MTM-DC data-collecting torque testers, as well as the ADW-DC data-collecting torque wrench. Create a database of tools and store test results with this easy-to-use software integrator to/from tester to PC.

Tool Manager Software

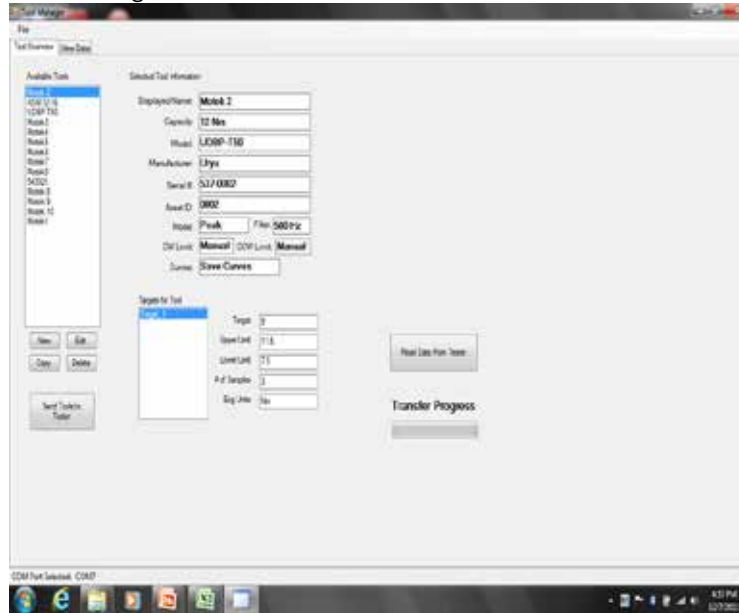

AUDITOR™ AUDIT MANAGER SOFTWARE

Audit Manager Software is included with the purchase of ATDA-DC data collecting torque analyzers. The View Data tab allows you to look at the collected data and the trace file. This data can be exported to Excel as a .csv file and displayed by Excel charts. The trace file displays the data in a torque/time graph and allows the user to supersede the move-on reading selected by the wrench by visually discerning via the trace where the fastener started to rotate. When selecting a single job the average, range, sigma, Cp, and CpK values are listed.

Audit Manager Software

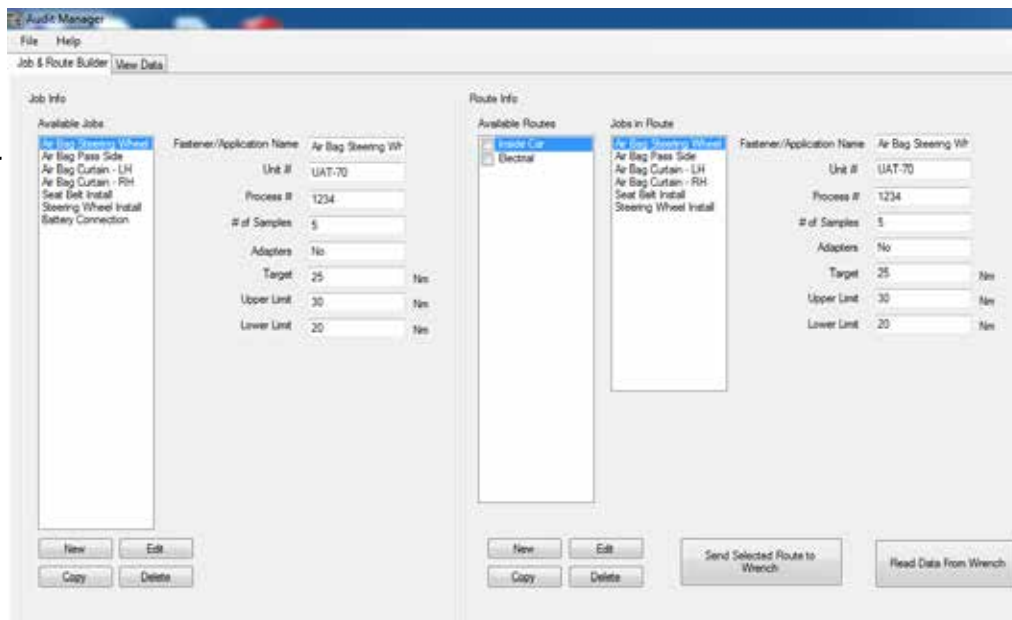





AUDITOR™ HIGH CAPACITY TEST STANDS

TORQUE MEASUREMENT: HIGH CAPACITY TEST STANDS

Features and Benefits

- Advanced test stations for larger tools and higher torque output
- Configured to meet application requirements
- Durable industrial grade devices

					
	AHCTS	AHCTS-K	AHDTS	AHBTS	AIMTS
	Auditor High Capacity Test Stand	Auditor High Capacity Test Stand - Hydraulic	Auditor High Capacity Test Stand Dual Transducer	Auditor High Capacity Stand w/variable joint simulation	Auditor High Capacity Impact Test Stand
	Designed for testing tools with continuous rotating output spindles and pulse tools.	Specifically designed for hydraulic wrenches testing.	Two transducers, one for rotary tools and one for hydraulic tools. Includes rundown & reaction fixtures with a single display.	Designed for testing rotating tools without the use of rundown fixtures. Adjustable airbrake joint simulation eliminates CCW rotation after rundown.	Ideal for testing impact wrenches and is recommended to utilize rundown fixtures when testing impacts.
Capacity	6,750 Nm	33,750 Nm	33,750 Nm	6,750 Nm	2,700 Nm

ACCESSORIES

Rundown fixtures					
AHCTS-3/4RDF		X		X	
AHCTS-1RDF		X		X	
AHCTS-1.5RDF		X		X	
Insert Square Drive Adapters					
CA1510	1-1/2" Male to 1" Female	X		X	
CA1550	1-1/2" Male to 1/2" Female	X		X	
CA1575	1-1/2" Male to 3/4" Female	X		X	
CA2510I	2-1/2" Male to 1" Female	X		X	
CA2515I	2-1/2" Male to 1-1/2" Female	X		X	
CA2575I	2-1/2" Male to 3/4" Female	X		X	
CA150108DHD	1-1/2" Male to 1-1/2" Male Hex		X		

Please refer to the Test Stand Configurator in Appendix C on 42 for required ordering options.

AUDITOR™

AUDITOR™ HIGH-CAPACITY TEST STANDS



AHCTS-5000

AHCTS TEST STAND FOR ROTATING TOOLS

Designed for testing tools with continuous rotating output spindles. The test stand includes a rundown fixture, bushing for side load support, reaction post or reaction paddles, transducer and torque analyzer display.

MODEL	DESCRIPTION
AHCTS-0500	3/4" Square Drive w/rundown fixture
AHCTS-2500	1.5" Square Drive w/rundown fixture
AHCTS-7500	1.5" Square Drive w/rundown fixture
AHCTS-5025*	1.5" Sq Dr dual station w/rundown fixture and reaction devices

*This stand has two transducers embedded into the base, one for rotary tools and one for hydraulic tools, and comes with rundown and reaction fixtures and one display.

**Please refer to 42 for required ordering options.

Optional Pelican Case shown (ordered separately)



25503



AHCTS-001K

AHCTS-K STAND FOR HYDRAULIC TOOLS

The AHCTS-K stands are specifically designed for hydraulic wrench testing. Hydraulic wrenches have very low profiles but very high torque output, therefore, working height must be minimized to prevent side loading which could lead to errors in data or damage to tool or reaction devices.

Either stand can be ordered with options such as extension legs, casters, embedded or attached torque analyzers with various rundown fixtures and reaction devices. Contact an AIMCO Customer Service Associate for additional information, 1-800-852-1368.

MODEL	DESCRIPTION
AHCTS-0.5K	3/4" Square Drive w/reaction device
AHCTS-001K	1" Square Drive w/reaction device
AHCTS-2.5K	1.5" Square Drive w/reaction device
AHCTS-005K	1.5" Square Drive w/reaction device
AHCTS-010K	1.5" Square Drive w/reaction device
AHCTS-025K	2" Square Drive w/reaction device

AUDITOR™ HIGH-CAPACITY TEST STANDS

AIMTS TEST STAND FOR IMPACT TOOLS

Obtain accurate test results with the AIMTS Series Impact Test Stand. When used with an Auditor ATDA Analyzer or AUET/MTM Desktop Torque Tester, the tool's performance data can be recorded and stored. Each Auditor Analyzer comes standard with PC-based software to store and organize data for use within a quality system. It is necessary to bolt the AIMTS to a bench. We also recommend that a rundown fixture always be used for testing impacts.



AIMTS-0500
Test stand for small impact tools



AIMTS-2000
Test stand for large impact tools

MODEL	DESCRIPTION
AIMTS-0500	3/4" square drive impact test stand
AIMTS-2000	1.5" square drive impact test stand

Please refer to the Test Stand Configurator in Appendix C on page 42 for required ordering options.

AHBTS TEST STAND WITH BRAKING SYSTEM FOR ROTATING TOOLS

These test stands are for testing rotating tools without requiring the use of rundown fixtures. We utilize an airbrake for testing tools that cannot or should not be used in reverse. These test stands are compatible with any Auditor Torque Analyzer.



AHBTS-2500
Auto Release test stand for quickly testing large rotating tools

MODEL	DESCRIPTION
AHBTS-2500	1.5" square drive, brake system w/reaction device, rotary transducer and display
AHBTS-5000	1.5" square drive, brake system w/reaction device, rotary transducer and display

AUDITOR™ TORQUE WRENCHES

TORQUE MEASUREMENT: TORQUE WRENCH

Features and Benefits						
	ADW	ADW-DC	APTW	ATW	Freedom3 Digital Wrench	FWE
	* Auditor Digital Wrench	* Auditor Digital Wrench with Data Collection	Auditor Preset Torque Wrench	Auditor Torque Wrench	Freedom3 Torque/Angle Wrench	Electric Torque Wrench
Torque Range	7 - 370 ft/lbs 10 - 500 Nm	7 - 370 ft/lbs 10 - 500 Nm	4 - 250 ft/lbs 5 - 340 Nm	4 - 148 ft/lbs 5 - 200 Nm	1.1 - 885 ft/lbs 1.5 - 1,200 Nm	1.1 - 885 ft/lbs 1.5 - 1,200 Nm
	Digital wrench with multiple head options for line side testing/auditing	Digital wrench with multiple head options for line side testing/auditing. Data Collector	Interchangeable heads. Preset uses proprietary adjustment tool to guard against unauthorized setting changes	Transducer on a stick. Communicates with Data Collector Testers and Analyzers	Freedom3 offers a uniquely complete tightening solution with large color touchscreen and 1 GB of memory	Transducerized wrench communicates with DataTouch Analyzer (required)
Bi-Directional accuracy of +/- X of indicated reading within the top 90% of the Tester's capacity	1%	1%	3%	0.50%	1%	1%
Software Included	X	X			X	

USED IN CONJUNCTION WITH

ATDA(DC) Data Analyzer				X		
AUET(DC) Tester				X		
AUET/MTM(DC) Tester				X		
DataTouch3 Data Analyzer						X

TORQUE WRENCH LOADERS



For Calibration of all types of torque wrenches eliminating human variable for more accurate measurement - digital transducer used with ATDA-8000-10-DCA

ATWL-250	Torque range up to 250 ft/lbs
ATWL-750	Torque range up to 750 ft/lbs
ATWL-1000	Torque range up to 1000 ft/lbs

See Appendix B on page 40 to configure wrench with options.

AUDITOR™ DIGITAL WRENCH SERIES



ADW-0010K111312222



ADW-1400F125312222

ADW DATA COLLECTING TORQUE WRENCH

- Large memory capacity.
- Every torque value has associated trace file.
- “Pick a Point” and “Move On” feature.
- Barcode scanner.
- Alpha Numeric screen for entering text.
- Field replaceable batteries.
- Docking station connection.
- Serial connection.
- Battery charger connection.
- Ergonomic handle.
- Switch between measure and data collection modes at any time.
- Multiple files and route capability.
- Data memory and simple statistics “On Board”.
- Complete statistical analysis, data archiving and exporting in Audit Manager software.
- Five models standard ranges 10 - 500 Nm full scale.
- Torsion transducer – not length dependent.
- Transducer is replaceable.
- 1,400 Nm model uses different handle design.

MODEL	TORQUE RANGE		WEIGHT		OVERALL LENGTH		SO. DRIVE
	NM	FT-LB	LB	KG	IN	MM	IN
ADW-0010K	1 - 10	0.7 - 7.4	2.2	1	18	457.2	1/4
ADW-0075K	7.5 - 75	5.5-55	3.1	1.4	23.5	596.9	3/8
ADW-0180K	18 - 180	13-130	3.6	1.6	30.1	765.2	1/2
ADW-0270K	27 - 270	20-198	3.6	1.6	30.1	765.2	3/4
ADW-0500K	50 - 500	37-369	4	1.8	36	914	1
ADW-1400F	140 - 1,400	103-1,033	4.8	2.2	60	1524	1

Unit accuracy is $\pm 1.0\%$ FSD of indicated reading for the top 95% of full scale as indicated above.

Each model includes a case, a battery charger, and a standard square-drive head. Other heads are available at additional cost.

*Part numbers with K, D or F followed by a 1 designate models with file and route capability. K followed by 2 indicate sequential memory but no file capability.

Part numbers with K, D or F followed by a 1,1 indicate file and route with bar code and docking station capability. K, D or F followed by a 1,2 indicate file and route capability with serial port only.

Please refer to the Wrench Configurator in Appendix B on page 40 for required ordering options.



ADW-DS

DOCKING STATION

- Nest for accepting all wrench sizes.
- Charger and serial communication accomplished through docking station.
- Bench mountable.

AUDITOR™ ELECTRONIC TORQUE WRENCHES

ALLOW PRECISE TIGHTENING AND AUDITING OF YOUR ASSEMBLY APPLICATIONS



“TRANSUCERS ON A STICK”

- Non-Length Dependent – Where the operator’s hand is positioned during use has no effect on torque readings.
- Available in Industry Standard (IS) or Intelligent (Intellect) Configurations – Transducer is compatible with a wide variety IS style instruments or Auditor™ Intellect instruments that self recognize the transducer.
- Durable – Steel, Aluminum and Carbon Fiber construction providing optimal strength and weight characteristics. Transducer supplied with overload capacity of 150% of full scale.
- Accurate – Torque readings are accurate to 1% of indicated reading in top 95% of full scale.

MODEL	TORQUE RANGE		SQUARE DRIVE
	Nm	ft-lb	in
ATW-0100F	14-136	10-100	3/8
ATW-0200F	27-272	20-200	1/2
ATW-0500F	68-680	50-500	3/4
ATW-1000F	136-1360	100-1000	1

Unit accuracy is $\pm 0.5\%$ of indicated reading for the top 90% of full scale as indicated above.
Required Accessory: ATDBRIS IS cable to connect Auditor™ ATDA instrument.

AUDITOR™ PRESET TORQUE WRENCHES

FEATURES AND BENEFITS

- Easy-to-use preset wrenches for fastener torque auditing.
- Torque ranges from 5 – 340 Nm.
- User friendly, sleek, ergonomic design.
- Tactile feedback on achievement of preset torque.
- Proprietary adjustment tool guards against unauthorized setting changes.
- Wide range of interchangeable heads provide flexibility and convenience.
- +/- 3% accuracy when used in clockwise or counterclockwise directions.



Preset Wrenches	Description
APTW-25	Auditor Preset Torque Wrench, 5 - 25 Nm, Accepts 12 mm Inserts
APTW-50	Auditor Preset Torque Wrench, 10 - 50 Nm, Accepts 12 mm Inserts
APTW-100	Auditor Preset Torque Wrench, 20 - 100 Nm, Accepts 12 mm Inserts
APTW-150	Auditor Preset Torque Wrench, 30 - 150 Nm, Accepts 12 mm Inserts
APTW-200	Auditor Preset Torque Wrench, 40 - 200 Nm, Accepts 14 mm Inserts
APTW-340	Auditor Preset Torque Wrench, 60 - 340Nm, Accepts 14 mm Inserts

Ratchet and Square Drive Heads	Description
APTH-12RT25	Auditor Preset Torque Wrench Ratchet Insert, 1/4 SQ DR, 12 mm
APTH-12RT38	Auditor Preset Torque Wrench Ratchet Insert, 3/8 SQ DR, 12 mm
APTH-12RT50	Auditor Preset Torque Wrench Ratchet Insert, 1/2 SQ DR, 12 mm
APTH-14RT50	Auditor Preset Torque Wrench Ratchet Insert, 1/2 SQ DR, 14 mm
APTH-14RT34	Auditor Preset Torque Wrench Ratchet Insert, 3/4 SQ DR, 14 mm
APTH-12SD25	Auditor Preset Torque Wrench SQ DR Insert, 1/4 SQ DR, 12 mm
APTH-12SD38	Auditor Preset Torque Wrench SD DR Insert, 3/8 SQ DR, 12 mm
APTH-12SD50	Auditor Preset Torque Wrench SQ DR Insert, 1/2 SQ DR, 12 mm
APTH-14SD50	Auditor Preset Torque Wrench SQ DR Insert, 1/2 SQ DR, 14 mm



Open End Heads	Description
APTH-120E7	Auditor Preset Torque Wrench Insert 7 mm OE, 12 mm
APTH-120E8	Auditor Preset Torque Wrench Insert 8 mm OE, 12 mm
APTH-120E9	Auditor Preset Torque Wrench Insert 9 mm OE, 12 mm
APTH-120E10	Auditor Preset Torque Wrench Insert 10 mm OE, 12 mm
APTH-120E11	Auditor Preset Torque Wrench Insert 11 mm OE, 12 mm
APTH-120E12	Auditor Preset Torque Wrench Insert 12 mm OE, 12 mm
APTH-120E13	Auditor Preset Torque Wrench Insert 13 mm OE, 12 mm
APTH-120E14	Auditor Preset Torque Wrench Insert 14 mm OE, 12 mm
APTH-120E15	Auditor Preset Torque Wrench Insert 15 mm OE, 12 mm
APTH-120E16	Auditor Preset Torque Wrench Insert 16 mm OE, 12 mm
APTH-120E17	Auditor Preset Torque Wrench Insert 17 mm OE, 12 mm
APTH-120E18	Auditor Preset Torque Wrench Insert 18 mm OE, 12 mm
APTH-120E19	Auditor Preset Torque Wrench Insert 19 mm OE, 12 mm
APTH-140E13	Auditor Preset Torque Wrench Insert 13 mm OE, 14 mm
APTH-140E14	Auditor Preset Torque Wrench Insert 14 mm OE, 14 mm
APTH-140E15	Auditor Preset Torque Wrench Insert 15 mm OE, 14 mm
APTH-140E16	Auditor Preset Torque Wrench Insert 16 mm OE, 14 mm
APTH-140E17	Auditor Preset Torque Wrench Insert 17 mm OE, 14 mm
APTH-140E18	Auditor Preset Torque Wrench Insert 18 mm OE, 14 mm
APTH-140E19	Auditor Preset Torque Wrench Insert 19 mm OE, 14 mm
APTH-140E21	Auditor Preset Torque Wrench Insert 21 mm OE, 14 mm
APTH-140E22	Auditor Preset Torque Wrench Insert 22 mm OE, 14 mm
APTH-140E24	Auditor Preset Torque Wrench Insert 24 mm OE, 14 mm
APTH-140E27	Auditor Preset Torque Wrench Insert 27 mm OE, 14 mm
APTH-140E30	Auditor Preset Torque Wrench Insert 30 mm OE, 14 mm
APTH-140E32	Auditor Preset Torque Wrench Insert 32 mm OE, 14 mm
APTH-140E34	Auditor Preset Torque Wrench Insert 34 mm OE, 14 mm
APTH-140E36	Auditor Preset Torque Wrench Insert 36 mm OE, 14 mm
APTH-140E38	Auditor Preset Torque Wrench Insert 38 mm OE, 14 mm
APTH-140E41	Auditor Preset Torque Wrench Insert 41 mm OE, 14 mm

SCS WRENCHES

TORQUE MEASUREMENT: SCS WRENCHES

Features and Benefits

- Torque and Angle Measurement
- Wireless Communication (optional)
- Use as a production wrench or for quality control with high-resolution touch screen display storing data points and curves for quick viewing or transfer to PC



	Freedom3 DIGITAL WRENCH	FWE TA	FWE
Torque Range	11 - 740 ft/Lbs 15 - 1000 Nm	11 - 740 ft/Lbs 15 - 1000 Nm	11 - 740 ft/Lbs 15 - 1000 Nm
Performance/Display	1GB Memory stores 20,000 values / 20,000 curves / 1,000 parameter sets, 80 Mips CPU, 32-Bit processor HiRes 2.3" Touch-screen display, 320 x 240 pixel resolution Li-Io rechargeable battery 3.6V 2700mAh, 9 hrs charge	-	-
Bi-directional Measurement accuracy of + / -	.5% in top 80% of range 1.0% in top 90% of range 0.1% display deviation of angle	-	-
Firmware			
LAB: Use to create tests on wrench, then store results including curves on wrench. These results can be downloaded to PC via F3 Explorer	X	X	X
SPC: Jobs and routes are developed for QC and Production via SQnet and downloaded/uploaded to/from wrench	X	X	
PRW: Used as production tool - communicating on-line via radio, BT or Wi-Fi where results are published in real time using VPG software	X		
Software			
F3 Explorer: Collects data results/curves > edit/export to Excel	X	X	
SQnet: Transfers jobs and routes data to/from device to PC	X	X	
VPG: Real time data transfer via wireless communication	X		
Options (must include with tool purchase)			
Barcode Reader Integrated (optional)	X		
Bluetooth Module Integrated Beneficial in PRW mode to communicate with VPG Software	X		
WiFi Module Integrated Beneficial in PRW mode to communicate with VPG Software	X		

ACCESSORIES

Battery Cradle	X		
USB Cable	X		
External Battery Charger	X		
Body Jacket	X		

WRENCH USED IN CONJUNCTION WITH

DataTouch		X	X
-----------	--	---	---

FREEDOM RATCHETS AND SOCKETS

Reversible ratchet	X	X	X
Open end ratchet	X	X	X
Ring end ratchet	X	X	X
Ring open	X	X	X
Recognition chip option	X	X	X

SCS FREEDOM3 WRENCH

The Freedom3 Wrench offers a uniquely complete tightening solution. Its patented angle measuring system, large color touchscreen, and internal 1 GB memory, make it the best performing and flexible torque/angle wrench on the market.

Features and Benefits

- Full-color 2.8" touchscreen provides a graphical display with zoom/plot features for easy viewing.
- Vibration and LED visual queues advise when target torque/angle is reached, reducing the risk of overtightening.
- Save time by creating a tightening strategy on the wrench without connecting to a PC.
- Capable of communicating with PLC and system network where collected data can be stored.
- Auto-recognition of insert head assures accuracy is maintained when interchanging head inserts of differing length.
- Docking station for safe storage and easy battery recharge.
- Bar code reader for efficient route management and data output (optional).
- Wireless technology (optional) synchronizes routes and data from multiple locations on the production line, enabling real-time analysis.
- Two firmware options enable the wrench to work on a wide range of production/assembly applications
 - SPC/LAB Firmware for laboratory analysis and quality control testing.
 - PRW Firmware for production line or rework stations.
- Long battery life provides up to 8 hours of continuous operation.



FRDM3-100



Specifications

Capacity 1.5–1,200 Nm (90% of full scale)
 Output 1GB memory stores 20,000 Values with Curves over 1,000 Parameter sets

Repeatability

Torque +/- 1% accuracy when used in top 90% of wrench range.

Angle +/- 0.1% display deviation of angle

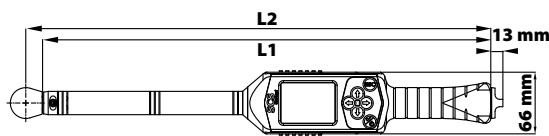

Model	Capacity		Drive mm	L1* mm	L2* mm	Weight*	
	Nm	Ft-Lb				lb	kg
FRDM3-15	15	11	9 x 12 female	375	393	1.8	0.8
FRDM3-30	30	22	9 x 12 female	375	393	1.8	0.86
FRDM3-70	70	52	9 x 12 female	480	498	2.1	0.93
FRDM3-100	100	74	9 x 12 female	480	498	2.1	0.93
FRDM3-200	200	148	14 x 18 female	604	629	3.3	1.5
FRDM3-300	300	221	14 x 18 female	754	779	4.1	1.86
FRDM3-400	400	295	14 x 18 female	754	779	4.1	1.86
FRDM3-600	600	442	14 x 18 female	1,032	1,057	8.0	3.65
FRDM3-800	800	590	Ø20 male	1,250	1,330	11.2	5.1
FRDM3-1000	1,000	737	Ø20 male	1,520	1,610	13.8	6.25
FRDM3-1200	1,200	885	Ø28 SA female	1,732	1,578	15.4	7.0

* without ratchet

Call for quote on devices with larger capacities

FRDM3 models include predisposition for battery cradle and auto recognition of inserted socket on wrench

SCS FREEDOM3 WRENCH

Freedom3 Wrench is available as a Quality or Production wrench, enabling it to work on a wide range of production/assembly applications.

- Quality: SPC/LAB Firmware for laboratory analysis and quality control testing.
- Production: PRW Firmware for production line or rework stations.



Choose testing method Test joint View torque/time, torque angle graphs on wrench Transfer data where applicable

Tightening Strategy – Quality

With Freedom3 Wrench, tightening strategies can be monitored using techniques designed to minimize joint elongation of typical breakaway testing. New breakaway methods employ an algorithm to protect real breakaway point and produce similar results regardless of operator influence.

- **Breakaway Angle**
Preset angle 1–4° and wrench will return torque value reached at the specified angle of rotation.
- **Smart Breakaway Angle**
Preset angle but returns either First Peak or Residual Torque values. See graph of typical hard joint curve.

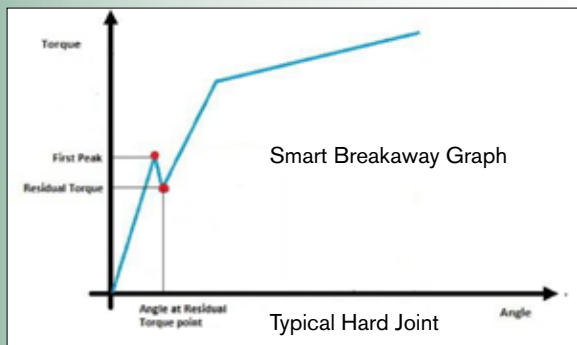

- **Breakaway Open/Close**
Rotate joint CCW a specific degree of angle then retighten CW the same rotation value to move bolt back to original position. Wrench returns torque value at the preset rotation parameter.
- **Minimum Torque**
Validate that the joint meets established torque parameter by setting angle rotation value. Wrench returns pass/fail value.
- **Joint Analysis**
Wrench will sense yield point and produce joint curves and save as yield torque, yield angle, max torque and angle at max torque. Graphic display assists in defining best tightening strategy.

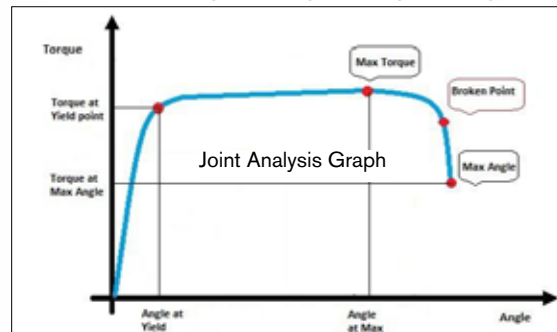

Tightening Strategy – Production

The Freedom3 Wrench is designed to work in real-time as an assembly tool on the production line.

- Wrench operates as a transducerized hand held nutrunner in production.
- Use for critical fastening duties with precise torque control.
- Visual display of torque data including curves.
- Create a route (list of tightening programs) using SQNet software building parameters necessary for any production process.
- Real time data transfer to quality system through VPG software.
- Use as backup tool.

SCS FWE/FWETA ELECTRONIC WRENCH

The FWE Wrench is an economic alternative to the Freedom3 Wrench. FWE utilizes the same high-quality firmware/software programs and can be cabled to the DataTouch Data Analyzer.

Features and Benefits

- Cabled torque wrench measures torque or torque/angle for simplified testing of critical joints.
- 11 standard models offer a range of 1.5 to 1,200 Nm to accommodate a wide range of applications.
- Available with internal memory for automatic recognition when connected to the DataTouch3.
- Standard end-fittings 9 x 12 or 14 x 18 allow the use of standard bits.



Freedom FWE 30



Freedom FWE or FWE TA

Use in conjunction with



DataTouch3 Analyzer

Specifications

Capacity 1.5–1,200 Nm (wrenches capable of function within top 90% of full scale)

Model	Function
FWE TA	Torque/Angle
FWE	Torque only

Model	Capacity		Drive in
	Nm	ft-lb	
Freedom FWE(TA) 15	15	11	9 x 12
Freedom FWE(TA) 30	30	22	9 x 12
Freedom FWE(TA) 70	70	52	9 x 12
Freedom FWE(TA) 100	100	74	9 x 12
Freedom FWE(TA) 200	200	148	14 x 18
Freedom FWE(TA) 300	300	221	14 x 18
Freedom FWE(TA) 400	400	295	14 x 18
Freedom FWE(TA) 600	600	442	14 x 18
Freedom FWE(TA) 800	800	590	Ø20
Freedom FWE(TA) 1000	1,000	740	Ø20
Freedom FWE(TA) 1200	1,200	885	Ø28

FWE models measure torque. FWE-TA models measure torque/angle.
Call for quote on devices with larger capacities

TORQUE CARTS

TORQUE MEASUREMENT: TORQUE CARTS

Features and Benefits

- Test on repeatable joint simulators or production joints
 - Simple to sophisticated options
 - Manual or self-propelled
 - Mobile test carts can be configured for testing continuous and discontinuous drive tools that include DC electric, clutch, battery, impulse, and torque wrenches
 - Each cart is customizable to meet testing needs from 1 - 1,356 Nm
- Contact your AIMCO representative for a quote or more information



iTVC

FTY

MSB

Hydraulic Braking Technology

- Dry braking with multiple hydraulic cylinders where thrust is generated equally to allow better linear control of the braking ramp
- Programmable joint characteristics for use with continuous drive tools - no unwinding required after testing

UFT Repeatability Joint Simulator

- Mechanically adjustable hydraulic pressure circuits allow the bolt tightening body to be configured to simulate various joint characteristics
- Ideal for repeatable, linear joint rate simulation while testing all tools including impulse tools

DataPro Software

Torque Wrench Loader Option

X

X

X*

X*

X

X

X

X

X

X

* Optional equipment - extension added to cart

AUDITOR TORQUE CART



iTVC Torque Cart

AIMCO offers torque carts for “lineside” or “point of use” tool validation and calibration. Our torque carts allow testing of tools on repeatable joint simulators and “in process” use on production joints, allowing users to identify process capability. There are multiple torque cart options:

- Manual push carts equipped with simple torque testers.
- Manual push carts equipped with data collectors and database application software.
- Self propelled cart with computer and relational database application.
- Driven cart with computer and relational database application.

Each cart can be equipped to specific customer requirements. Maximum torque range on board torque cart is 1,000 ft-lb or 1,356 Nm. Ancillary test stands up to 50,000 ft-lb available.

SCS TORQUE CART

High-precision torque carts able to simulate a fastener in all conditions



MSB Torque Cart



FTY Torque Cart

The FTY Torque Cart includes all of the features and benefits of the MSB Torque Cart, *plus* hydraulic braking technology for better linear control of the braking ramp.

Features and Benefits

- ISO 5393, VDI 2862, ISO 6789, VDE 2647
- Sophisticated DataPro software
- Time saving testing of tools with the same tightening strategy as used on production line
- Comparative test analysis
- Lightweight



Specifications

- USB interface
- Sampling frequency of up to 30 kHz with settable filter up to 3 kHz
- Accuracy of 0.5% within top 90% of full scale
- Tests power tools up to 1,356 Nm

DATA COLLECTION SOFTWARE

DATAPRO SOFTWARE - TORQUE CART DATA MANAGEMENT

As the data management system for the AIMCO Torque Cart line, DataPro and SQnet software provide tool management, verification, and calibration. Users can manage complete tool inventory, create jobs/routes, and store collected data. Calibration sequencing can be scheduled by time or number of rundowns.

TORQUE VERIFICATION

DataPro displays sample values of torque, angle, and pulse count. It calculates statistics: average, Cp, Cpk, Six Sigma, and Mean variation. As values are measured, they are graphically plotted on a X-bar range chart scaled to specification limits.

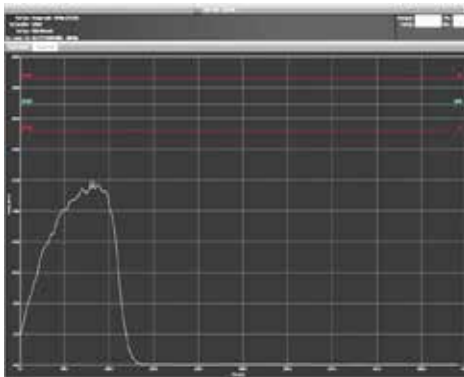

Torque Values from a Click Wrench

TRACES

The axis of the trace can be torque/time, torque/angle, angle/time. Save a trace, retrieve it, and overlay a new trace for comparison. Trace details are displayed at the bottom of the graph: max. values, plot time (ms), number of data points, filter frequency, and sample rate.

DATABASE INFORMATION

View operation lists and associated tools along with historic test or quality data. From the historic data screen, launch statistical graphs to view and analyze archived data. Graphs include X-bar range, histogram, Six Sigma, Cp, and Cpk graphs.

Database Displaying Production Test Results

SQNET SOFTWARE - QUALITY CONTROL AND PRODUCTION LINE

SQnet is designed to manage quality control of the production line, manage all the tools (supplier, models, technical specifications), and manage related quality-control tests (Cm, Cmk, and XR charts).

SQnet software communicates with Freedom3 wrench and DataTouch3 data analyzer to gather audit data from predetermined jobs and routes.

For Quality use, the software enables you to manage tools, operation locations, and quality-control of production lines.

For Production use, you can check residual torque or perform joint analysis in order to test bench settings and to set accurate tightening parameters.

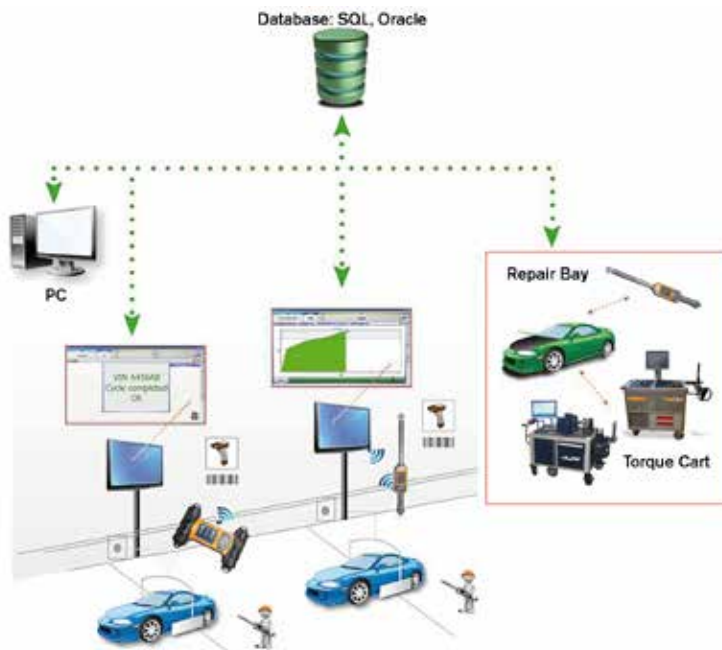

DATA COLLECTION SOFTWARE

FREEDOM3 EXPLORER SOFTWARE - QUALITY CONTROL

Freedom3 Explorer software enables collection of data, results, and curves from the ADET analyzer, the DataTouch3 analyzer, and the Freedom3 torque wrench. The software displays single or multi-curve graphs, and provides easy analysis of minimum/maximum torque, minimum/maximum angle, and final torque. Data can be exported to Excel.

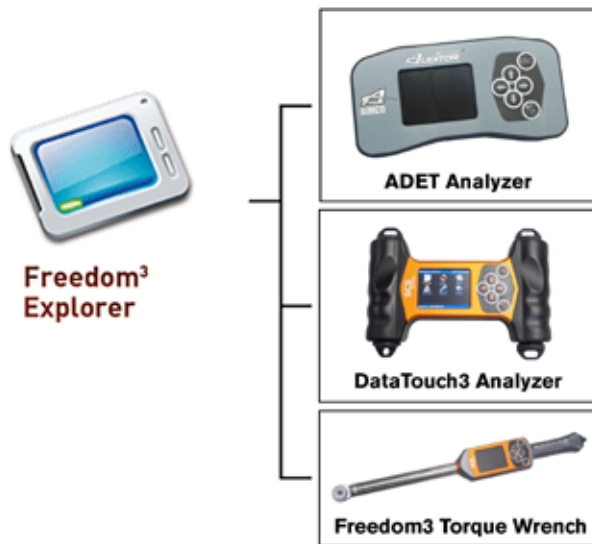
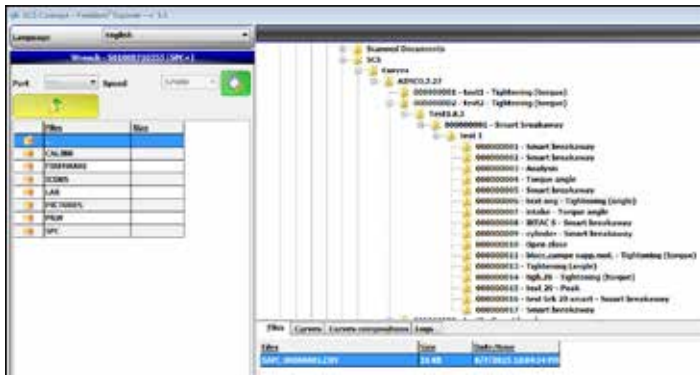

LAB results from wrench

VPG SOFTWARE - PRODUCTION LINE

VPG (Visual Production Guide) software works with Freedom3 torque wrench, and enables operators to configure assembly and rework processes.

From the computer, VPG sends tightening programs to Freedom3. Operators are driven through different tightening sequences. The software automatically selects the correct tightening program, and displays instructions accompanied by a picture of the operations, complete with status (to be tightened, OK and NOK). In rework mode, the user can manually select the sequences.

From the production line, Freedom3 sends real-time critical-joint fastening data after each tightening immediately to the PC. If the network is unavailable, the station will store the results until network connection is restored. VPG software allows full tractability including torque control, angle control, and yield control.

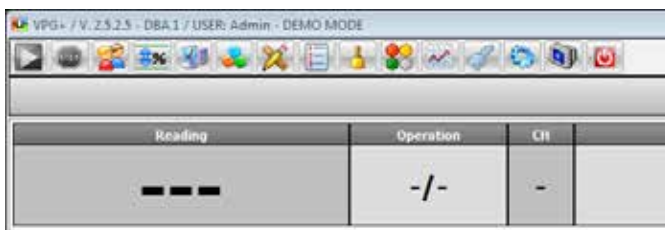

PRW real-time results from wrench to database - wireless

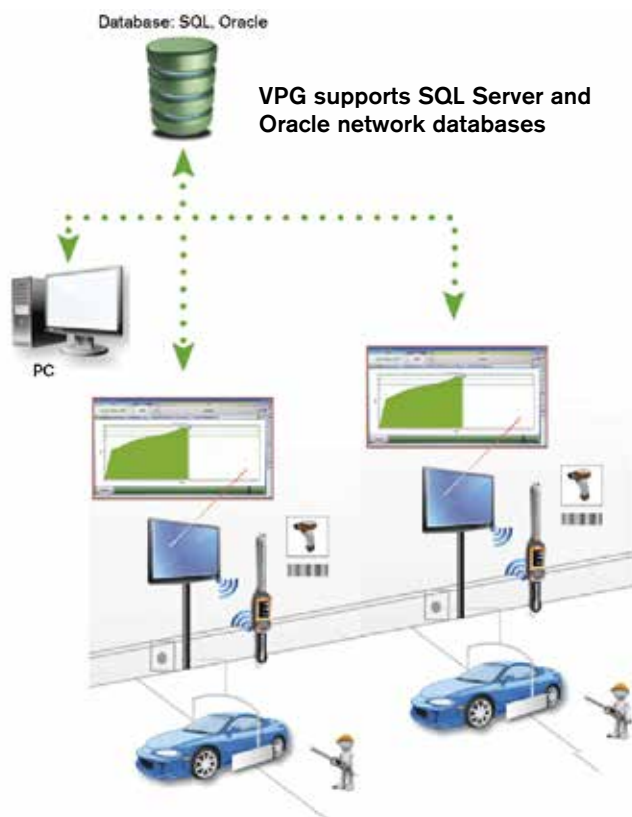

TRANSDUCERS

TORQUE MEASUREMENT: TRANSDUCERS

Features and Benefits

Superior:

- Accuracy
- Compatibility
- Durability

Auditor offers multiple styles of transducers in various configurations. Industry standard transducers (2mv/v) and intellect transducers for Auditor instruments that reduce configuration set up time.

Please contact our Customer Service Associates for additional information, 1-800-852-1368.

Used in Conjunction with Analyzers

	Stationary			Rotary		
	ASTIS	AISI - AISF	ASTB	ARTIS	ARTIS2	ARTB
ATC	X			X		
AUET	X			X		
AUET/MTM	X			X		
ATDA	X			X		
ATDA-8000		X				
ADET			X	X	X	X
DataTouch3			X	X	X	X

See Appendix A on page 40 to configure complete part.

AUDITOR™ STATIONARY TRANSDUCERS

Stationary Transducers with joint rundown fixtures and, where applicable, bench stands.



AISI

AISI/AISF Transducers connect to the ATDA-8000 analyzer and mount directly to a benchtop.

MODEL	MAX TORQUE		WEIGHT		W X H X D		DRIVE
	Nm	in-lb/ft-lb	kg	lb	mm	in	in
AISI-200025	2.8	25	1.13	2.5	79 x 95 x 83	3.13 x 3.75 x 3.25	1/4
AISI-200100	11.3	100	1.13	2.5	79 x 95 x 83	3.13 x 3.75 x 3.25	1/4
AISI-200500	56.5	500	1.13	2.5	79 x 95 x 83	3.13 x 3.75 x 3.25	3/8
AISF-200100	135.6	1,200/100	2.25	5	100 x 65	4 x 3	1/2
AISF-200250	339	3,000/250	2.25	5	100 x 65	4 x 3	1/2
AISF-201000	1350	12,000/1,000	2.8	6	100 x 65	4 x 3	1



ASTB

Can be connected to DataTouch or Auditor Torque Data Analyzers, or to a standard laptop via Bluetooth, allowing control of various types of power tools

MODEL	CAPACITY		DRIVE
	NM	FT-LB	IN
ASTB-25S-2C	2	1.5	1/4"
ASTB-75S-10C / ASTB-75R-10P	10	7	3/4" / SA 21
ASTB-75S-20C / ASTB-75R-20P	20	15	3/4" / SA 21
ASTB-75S-50C / ASTB-75R-50P	50	37	3/4" / SA 21
ASTB-75S-100C / ASTB-75R-100P	100	74	3/4" / SA 24
ASTB-75S-250C / ASTB-75R-250P	250	185	3/4" / SA 24
ASTB-75S-500C / ASTB-75R-500P	500	370	3/4" / SA 36
ASTB-100S-1000C / ASTB-1000R-1000P	1,000	740	1" / SA 46

R= ring nut drive, S= square drive

Call for quote on devices with larger capacities



ASTIS

ASTIS industry standard transducers can be used with multiple analyzers.

MODEL	MAX TORQUE		DRIVE
	Nm	in-lb/ft-lb	in
ASTIS-25D-11	11	100 in-lb	1/4
ASTIS-25D-28	28	250 in-lb	1/4
ASTIS-38D-135	135	100 ft-lb	3/8
ASTIS-50D-270	270	200 ft-lb	1/2
ASTIS-75D-1000	1017	750 ft-lb	3/4
ASTIS-100D-1700	1695 Nm	750 ft-lb	1

AUDITOR™ TRANSDUCERS

AUDITOR™ ROTARY TRANSDUCERS



ARTIS Series

Suitable for use with all continuous drive tools, impulse tools and torque wrenches.

MODEL	DRIVE	MAX TORQUE		LENGTH (A)	THICKNESS		WIDTH (C)	WEIGHT lb
		Nm	in-lb/ft-lb		(B)	(C)		
ARTIS-25H-2T(A)	1/4 Hex	2	18 in-lb	4.6	1.1	2.2	1.0	
ARTIS-25H-5T(A)	1/4 Hex	5	44 in-lb	4.6	1.1	2.2	1.0	
ARTIS-25H-20T(A)	1/4 Hex	20	180 in-lb	4.6	1.1	2.2	1.0	
ARTIS-25S-10T(A)	1/4 Sq.	10	88 in-lb	2.9	1.1	2.2	1.0	
ARTIS-38S-75T(A)	3/8 Sq.	75	50 ft-lb	3.0	1.6	2.7	1.2	
ARTIS-50S-180T(A)	1/2 Sq.	180	130 ft-lb	3.4	1.6	2.7	1.5	
ARTIS-75S-500T(A)	3/4 Sq.	500	370 ft-lb	4.1	2.0	3.1	2.2	
ARTIS-100S-1400T(A)	1 Sq.	1400	1025 ft-lb	4.9	2.4	3.6	4.0	

*Add "A" to the end of the part number to indicate torque/angle transducer.



ARTIS2-25S-10T

ARTIS2 Series

Can be connected to Auditor Torque Data Collector. Available with internal memory for automatic recognition when connected to Auditor Torque Data Collector.

MODEL	TORQUE		DRIVE IN
	NM	FT-LB	
ARTIS2-25H-2T	2	1.5	HEX 1/4"
ARTIS2-25H-5T	5	3.7	HEX 1/4"
ARTIS2-25S-10T	10	7	SQ. 1/4"
ARTIS2-25H-10T	10	7	HEX 1/4"
ARTIS2-25H-20T	20	15	HEX 1/4"
ARTIS2-25S-20T	20	15	SQ. 1/4"
ARTIS2-38S-25T	25	18	SQ. 3/8"
ARTIS2-38S-75T	75	55	SQ. 3/8"
ARTIS2-50S-180T	180	133	SQ. 1/2"
ARTIS2-75S-250T	250	184	SQ. 3/4"
ARTIS2-75S-500T	500	369	SQ. 3/4"
ARTIS2-75S-750T	750	553	SQ. 3/4"
ARTIS2-100S-1400T	1,400	1,033	SQ. 1"
ARTIS2-150S-3000T	3,000	2,213	SQ. 1 1/2"
ARTIS2-150S-5000T	5,000	3,688	SQ. 1 1/2"

Call for quote on devices with larger capacities

MODEL	TORQUE AND ANGLE		DRIVE IN
	NM	FT-LB	
ARTIS2-25H-2TA	2	1.5	HEX 1/4"
ARTIS2-25H-5TA	5	3.7	HEX 1/4"
ARTIS2-25S-10TA	10	7	SQ. 1/4"
ARTIS2-25H-10TA	10	7	HEX 1/4"
ARTIS2-25H-20TA	20	15	HEX 1/4"
ARTIS2-25S-20TA	20	15	SQ. 1/4"
ARTIS2-38S-25TA	25	18	SQ. 3/8"
ARTIS2-38S-75TA	75	55	SQ. 3/8"
ARTIS2-50S-180TA	180	133	SQ. 1/2"
ARTIS2-75S-250TA	250	184	SQ. 3/4"
ARTIS2-75S-500TA	500	369	SQ. 3/4"
ARTIS2-75S-750TA	750	553	SQ. 3/4"
ARTIS2-100S-1400TA	1,400	1,033	SQ. 1"
ARTIS2-150S-3000TA	3,000	2,213	SQ. 1 1/2"
ARTIS2-150S-5000TA	5,000	3,688	SQ. 1 1/2"

Call for quote on devices with larger capacities

ARTB WIRELESS TORQUE AND ANGLE ROTARY TRANSDUCERS







ARTB-25S-20TA

Can be connected to DataTouch or Auditor Torque Data Analyzers, or to a standard laptop via Bluetooth, allowing control of various types of power tools.

Model	Torque Range		Drive in
	Nm	ft-lb	
ARTB-25H-2T(TA)	0.2 - 2	0.2 - 1.5	HEX 1/4"
ARTB-25H-5T(TA)	0.5 - 5	0.4 - 3.7	HEX 1/4"
ARTB-25S-10T(TA)	1 - 10	0.7 - 7	1/4"
ARTB-25H-20T(TA)	2 - 20	1.5 - 15	HEX 1/4"
ARTB-25S-20T(TA)	2 - 20	1.5 - 15	1/4"
ARTB-38S-25T(TA)	2.5 - 25	2 - 19	3/8"
ARTB-38S-75T(TA)	7.5 - 75	6 - 56	3/8"
ARTB-50S-180T(TA)	18 - 180	13 - 133	1/2"
ARTB-75S-250T(TA)	25 - 250	19 - 185	3/4"
ARTB-75S-500T(TA)	50 - 500	37 - 370	3/4"
ARTB-100S-1400T(TA)	140 - 1,400	104 - 1,036	1"
ARTB-150S-3000T(TA)	300 - 3,000	222 - 2,220	1 1/2"
ARTB-150S-5000T(TA)	500 - 5,000	370 - 3,700	1 1/2"

Call for quote on devices with larger capacities



TORQUE MEASUREMENT RUNDOWN FIXTURES / JOINT SIMULATORS

RUNDOWN FIXTURE	MODEL SERIES	WEAR RESISTANT HEAVY DUTY	HEAVY DUTY FULLY ENCAPSULATED	HEAVY DUTY ENCAPSULATED WASHERS	STANDARD (INCLUDED W/ ANALYZER)	SPLINE DRIVE
	ARDIA-XXXHD	X				
	ARDFA-XXXHD	X				
	ARDFA-XXXHDS		X			
	ARDIA-XXXHDS		X			
	ARDFA-XXXHDE			X		
	ARDIA-XXXHDE			X		
	ARDFA-XXX				X	
	ARDIA-XXX				X	
	ARDA-XXX	X	X			X*

Fixtures can be ordered to simulate hard, med, or soft joints

Mechanical Belleville system of bolt, nut or nut body, Belleville washers and main housing, 1/4" - 3/4" drive sizes, 10 in/lbs - 1,200 ft/lbs

*Spline drive feature provides rundown control when testing pulse tools

JOINT SIMULATOR		
	AJKR-	Joint Kit for Rotary Transducer
	AJKS-	Joint Kit for Stationary Transducer

Provide linear response and are repeatable 1/4" - 1" drive sizes 28 - 1,695 Nm



Accurate, repeatable, linear, and durable. Tests 3 - 690 Nm, M5 - M24 fastener sizes
See page 38.

Design Type:	Power Tools	Impulse Tools
Square drive	X	
Spline Drive		X

Rundown Fixtures used in conjunction with these external transducers:	ASTIS	AIS-AISF	ARTIS	ASTB	ARTB
ARDIA/ARDFA	X	X	X		X
ARDA				X	X
AJKS	X		X		
AJKR			X		X
UFT			X		X

TORQUE MEASUREMENT RUNDOWN FIXTURES / JOINT KITS



AUDITOR™ RUNDOWN FIXTURES

To test power tools, pneumatic or electric, consistent rotational speed must be achieved. The joint rundown fixture/simulator provides the means by which the tool motor and spindle rotates freely at the start of the test cycle and then develops torque as resistance to rotation increases as load on the fastener and joint increases. The linearity and consistency of the joint rundown fixtures/simulators vary greatly and the tool test data is a product of the variations in these rundown fixtures. Higher quality joint rundown fixtures produce torque data with less scatter.

Rundown fixtures for heavy duty use.

MODEL*	DESCRIPTION	RECOMMENDED TORQUE RANGE		SQUARE DRIVE
		IN-LB	Nm	
ARDIA-10(HD)(HDE)(HDS)	Rundown Fixture	1.0 - 10	.13 - 1.13	1/4
ARDIA-25(HD)(HDE)(HDS)	Rundown Fixture	2.5 - 25	.28 - 2.8	1/4
ARDIA-100(HD)(HDE)(HDS)	Rundown Fixture	10.0 - 100	1.3 - 11.3	1/4
ARDIA-250(HD)(HDE)(HDS)	Rundown Fixture	25.0 - 250	2.8 - 28.25	3/8
ARDIA-500(HD)(HDE)(HDS)	Rundown Fixture	50.0 - 500	5.6 - 56.5	3/8

* Add "HD" to part numbers for wear resistant models. Add "HDS" to part numbers for fully encapsulated wear resistant models.

* Add "HDE" to part numbers for partial encapsulated wear resistant models.

MODEL*	DESCRIPTION	RECOMMENDED TORQUE RANGE		SQUARE DRIVE
		IN-LB	Nm	
ARDFA-100(HD)(HDE)(HDS)	Rundown Fixture	10 - 100	13.6 - 136	1/2
ARDFA-150(HD)(HDE)(HDS)	Rundown Fixture	15 - 150	20.4 - 204	1/2
ARDFA-250(HD)(HDE)(HDS)	Rundown Fixture	25 - 250	34.0 - 340	1/2
ARDFA-600(HD)(HDE)(HDS)	Rundown Fixture	60 - 600	81.6 - 816	3/4

* Add "HD" to part numbers for wear resistant models. Add "HDS" to part numbers for encapsulated wear resistant models.

* Add "HDE" to part numbers for partial encapsulated wear resistant models.

JOINT KITS



AJKR



AJKS

Joint kits are an essential accessory for accurate off-line testing of powered assembly tools.

- Represent production joint conditions off the production line
- Can be adjusted to include joint conditions specified by ISO 5393
- Allows free running of bolt before torque gradient
- Enables accurate tool test and set-up

DRIVE SIZE - IN	ROTARY KIT PART #	STATIONARY KIT PART #
1/4	AJKR-28	AJKS-25D
3/8	AJKR-135	AJKS-38D
1/2	AJKR-271	AJKS-50D
3/4	AJKR-1017	AJKS-75D
1	AJKR-1695	AJKS-100D

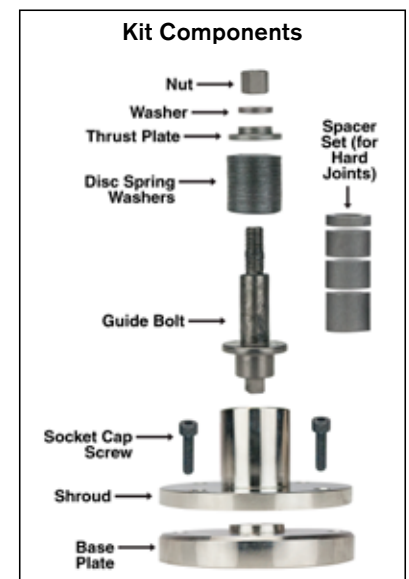

UFT SERIES JOINT SIMULATORS

UFT SERIES JOINT SIMULATORS

- AIMCO's UFT Joint Simulators offer the most repeatable and linear joint rate simulation of any product on the market.
- Pulse tool and continuous drive tool certification and testing.
- Consists of a bolt tightening body and a hydraulic pressure loading mechanism. A hydraulic pressure circuit connects these two bodies. Ideal for ISO 5393 test procedures.
- Three joint rates can be easily and quickly simulated by opening or closing two external valves.
- Specially coated testing bolt produces over 100,000 cycles without variation or deformation.



UFT-24



UFT-S10



UFT-S16

MODEL	BOLT SIZE	TORQUE RANGE		SNUG TORQUE NM	A-JOINT RATE NM/DEG	B-JOINT RATE NM/DEG	C-JOINT RATE NM/DEG	D-JOINT RATE NM/DEG	CENTER TO OUTSIDE X HEIGHT MM	WEIGHT	
		FT-LB	NM							LB	KG
UFT-S10	M6	5 - 11	6.7 - 14.7	2.7	0.36	0.10	0.04	0.02	76 x 203	43	19.5
	M8	11 - 23	14.7 - 31.4	7.5	0.79	0.26	0.06	0.03			
	M10	23 - 40	31.4 - 53.9	14.9	1.22	0.35	0.09	0.06			
UFT-S16	M12	40 - 65	53.9 - 88.2	27.5	1.80	0.51	0.22	0.09	97 x 256	88	40
	M14	65 - 110	88.2 - 149	44.0	2.70	0.79	0.22	0.14			
	M16	110 - 140	149 - 190	73.5	4.70	1.22	0.35	0.21			
UFT-24*	M18	140 - 217	190 - 294						138 x 171	108	49.1
	M20	217 - 325	294 - 441								
	M24	325 - 506	441 - 686								

* UFT-24 medium hard/soft joints only
Reaction fixture for continuous drive tools not included. Sockets included.

TORQUE MEASUREMENT CABLES

CABLES

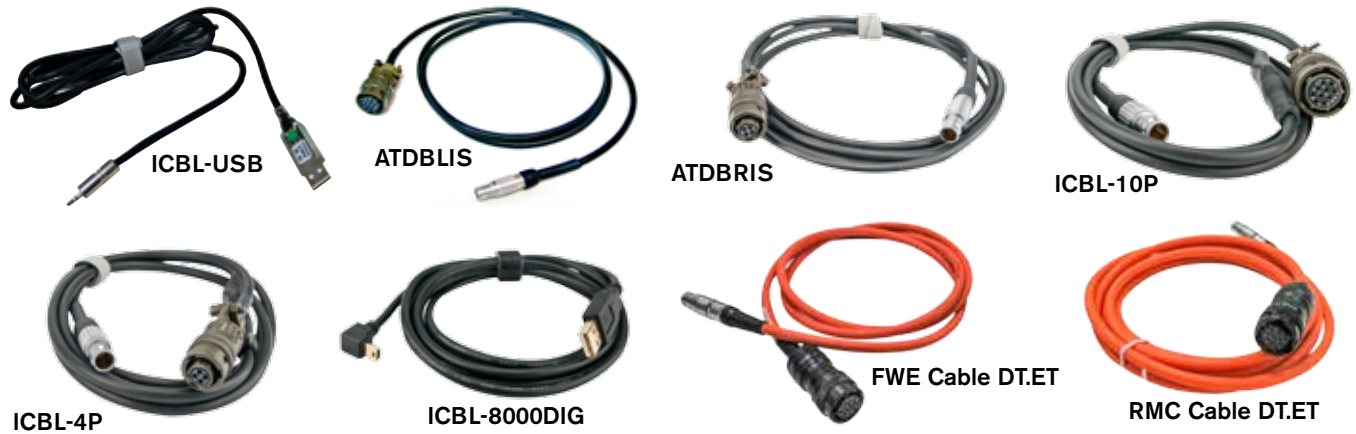

TORQUE MEASUREMENT: CABLES								
MODEL	DESCRIPTION	SERIAL CABLE	TRANSDUCER CABLE	ROTARY	ROTARY W/ANGLE	STATIONARY	IND STD	INTELLECT
ICBL-USB*	Connects between COM port of display to PC	X						
ATDBLIS*	Connect to IS transducer w/ angle - 10 pin		X		X		X	
ATDBRIS*	Connect to IS transducer - 4 pin		X	X		X	X	
ICBL-10P*	Intellect transducer cable. Identification chip in cable - 10 pin connector		X			X		X
ICBL-4P*	Intellect transducer cable. Identification chip in cable - 4 pin connector		X	X		X		X
ICBL-8000DIG	Connect from ATDA-8000 series analyzer to AISI / AIFI transducer		X					
RMC Cable DT.ET	Connect from DataTouch3 / ADET analyzer to ARTB / ARTS transducers		X	X	X	X		
FWE Cable DT.ET	Connect from DataTouch3 / ADET analyzer to FWE Wrenches		X					

* Compatible with ATDA, AUET, ADW products



CABLE COMPATIBILITY														
	ATC	AUET	AUET/MTM	AUET-DC	AUET/MTM-DC	ATDA	ATDA-DC	ATDA-8000	ATDA-8000-10-DCA(-TA)(-TP)	ADW	ADW-DC	FWE	AEDT	DataTouch
ICBL-USB	X	X	X	X	X	X	X			X	X			
ATDBLIS		X	X	X	X	X	X							
ATDBRIS		X	X	X	X	X	X							
ICBL-10P		X	X	X	X	X	X							
ICBL-4P		X	X	X	X	X	X							
ICBL-8000DIG								X	X					
RMC Cable DT.ET													X	X
FWE Cable DT.ET												X		

APPENDICES

APPENDIX A: TRANSDUCER CONFIGURATOR

Model Number	Base Model Number (1-11)					
	1	2	3	4	5	6
Examples of part numbers	A	I	S	I	-	2
	A	I	S	F	-	2
	A	X	R	N	-	1
Transducer Options and Configuration	Auditor	Configuration	Type	Units		Angle
		I = Intellect X = Industry Standard	R = Rotary S = Stationary W = Wireless	I = in lb F = ft lb N = NM		1 = Yes 2 = No

Base model number (first 11 characters) describes Auditor, Configuration Intellect or Industry Standard, Type Rotary, Stationary or Wireless, Engineering Units In Lb, Ft Lb or NM, Angle Yes or No and Capacity.

To complete configuration of a 15 character part number select options and configuration sequentially from column 1 through 15. Columns 7-11 specify torque capacity.

APPENDIX B: WRENCH CONFIGURATOR

Model Number Columns	Base Model Number (1-9)								
	1	2	3	4	5	6	7	8	9
Examples of part numbers	A	D	W	-	0	0	7	5	K
	A	D	W	-	0	0	1	0	K
	A	T	W	-	0	2	0	0	F
Wrench Options and Configuration	Auditor	Type	Wrench	Capacity					Style
		D = Digital T = Transducer							K = Katana D = Katana w/dovetail transducer F = "Stick" straight handle

Base model number (first 9 characters) describes Auditor, Type; Digital or Transducer, Capacity, Style; Katana, Katana w/Dovetail transducer or Stick.

To complete configuration of a 18 character part number select options and configuration sequentially from column 1 through 18. Columns 5-8 specify torque capacity.

APPENDICES

7	8	9	10	11	12	13	14	15
0	0	0	5	0	1	2	1	2
0	0	7	5	0	1	2	1	5
0	0	1	8	0	2	2	2	4
Capacity					Fixture	Expanded Range	Digital Transducer	Drive Size
					1 = Bench Stand 2 = Inline 3 = Loader	1 = Yes 2 = No	1 = Yes 2 = No	1 = 1/4" Hex 2 = 1/4" Sq 3 = 3/8" Sq 4 = 1/2" Sq 5 = 3/4" Sq 6 = 1" Sq 7 = 1-1/2" Sq

The base model number is not a complete part number, - Fixture, Expanded Range, Digital Transducer and Drive Size must be specified by building complete part number.

					Future Options (15-18)			
10	11	12	13	14	15	16	17	18
1	1	3	3	1	2	2	2	2
1	1	1	3	2	2	2	2	2
2	2	3	1	2	2	2	2	2
Data Collector	Bar Code Docking Station	Sq Dr	Configuration	Engineering Unit	Angle	Accelerometer	Graphics	Tone Generator
1 = Yes 2 = No	1 = Yes 2 = No	1 = 1/4" 2 = 3/8" 3 = 1/2" 4 = 3/4" 5 = 1" 6 = NA	1 = Intellect (intelligent td) 2 = IS (industry standard) 3 = NA (digital wrench)	1 = NM 2 = ft lb 3 = in lb	1 = Yes 2 = No	1 = Yes 2 = No	1 = Yes 2 = No	1 = Yes 2 = No
Not yet available so always enter 2 (No) for these options.								

The base model number is not a complete part number, - Data Collector, Bar Code & Docking Station, Sq Dr, Configuration, Engineering Unit and Future Options must be specified by completing 18 character part number.

APPENDICES

APPENDIX C: TEST STAND CONFIGURATOR

	Base Model Number (1-10)									
Model Number Columns	1	2	3	4	5	6	7	8	9	10
Example of part numbers	A	H	C	T	S	-	5	0	0	0
	A	H	C	T	S	-	5	0	0	0
	A	H	C	T	S	-	0	0	5	K
	A	H	B	T	S	-	2	0	0	0
Test Stand Configuration and options	Auditor	High	Cap	Test	Stand		Configuration & Capacity K= Hydraulic			

Base model number (first 10 characters) describes Auditor, High, Capacity or Brake, Test Stand, Torque Capacity and Configuration; Rotary or Hydraulic (K).

To complete configuration of a 18 character part number select options and configuration sequentially from column 1 through 18. Columns 7-10 specify torque capacity.

APPENDICES

	11	12	13	14	15	16	17	18
	1	3	3	5	7	1	1	2
	6	2	3	5	1	1	2	2
	1							
	4							
Display Options	Legs	Base Dimension	Rundown Fixture Options	Reaction Post Options	Casters	Arm for Display	Digital Module	
1 = ATDA	1 = 6" Legs	0 = 8" x 8"	1 = 500 ft lb capacity	1 = 6" Post	1 = Yes	1 = Yes	1 = Yes	
2 = No Embedded display	2 = No Legs	1 = 12' x 12"	2 = No rundown fixture	2 = No Post	2 = No	2 = No	2 = No	
3 = ATDA-DC	3 = 18" Legs	3 = 14" x 19"	3 = 1000 ft lb capacity	3 = 6" Posts				
4 = ATDA-8000 (7)	4 = Custom Legs in 6" increments	4 = 18" x 24"	4 = 2500 ft lb capacity	4 = Paddles				
5 = ATDA-8000-10 (10)		5 = 18" x 36"	5 = 5000 ft lb capacity	5 = Custom				
6 = Embedded Display		6 = NA no base plate	6 = 7500 ft lb capacity	6 = 9" Post				
7 = ATRC Module			7 = 1.5" rundown kit for "K" stands.	7 = 9" Posts				
			8 = 2.5" rundown kit for "K" stands.					

The base model number is not a complete part number, - Display Options, Legs, Base Dimension, Rundown Fixture, Reaction Post, Casters, Arm and Digital Module must be specified by building complete part number.

INDEX

MODEL #	PAGE	MODEL #	PAGE	MODEL #	PAGE	MODEL #	PAGE	MODEL #	PAGE
A-B		APTH-12SD38	25	ARTB-38S-75T(TA)	35	ASTIS-25D-28	34	FRDM3-70	27
ADET	16	APTH-12SD50	25	ARTB-50S-180T(TA)	35	ASTIS-38D-135	34	FRDM3-100	27
ADETB	16	APTH-14OE13	25	ARTB-75S-250T(TA)	35	ASTIS-50D-270	34	FRDM3-200	27
ADW-0010K	23	APTH-14OE14	25	ARTB-75S-500T(TA)	35	ASTIS-75D-1000	34	FRDM3-300	27
ADW-0075K	23	APTH-14OE15	25	ARTB-100S-1400T(TA)	35	ASTIS-100D-1700	34	FRDM3-400	27
ADW-0180K	23	APTH-14OE16	25	ARTB-150S-3000T(TA)	35	ATC-10	9	FRDM3-600	27
ADW-0270K	23	APTH-14OE17	25	ARTB-150S-5000T(TA)	35	ATC-25	9	FRDM3-800	27
ADW-0500K	23	APTH-14OE18	25	ARTIS-25H-2T(A)	35	ATC-100	9	FRDM3-1000	27
ADW-1400F	23	APTH-14OE19	25	ARTIS-25H-5T(A)	35	ATC-150F	9	FRDM3-1200	27
ADW-DS	23	APTH-14OE21	25	ARTIS-25H-20T(A)	35	ATC-250	9	FREEDOM3 EXPLORER	33
AHBTS-2500	21	APTH-14OE22	25	ARTIS-25S-10T(A)	35	ATC-250F	9	Freedom FWE(TA) 15	29
AHBTS-5000	21	APTH-14OE24	25	ARTIS-38S-75T(A)	35	ATC-500	9	Freedom FWE(TA) 30	29
AHCTS-0.5K	20	APTH-14OE27	25	ARTIS-50S-180T(A)	35	ATC-750F	9	Freedom FWE(TA) 70	29
AHCTS-1.5RDF	19	APTH-14OE30	25	ARTIS-75S-500T(A)	35	ATDA	14	Freedom FWE(TA) 100	29
AHCTS-001K	20	APTH-14OE32	25	ARTIS-100S-1400T(A)	35	ATDA-8000	15	Freedom FWE(TA) 200	29
AHCTS-1RDF	19	APTH-14OE34	25	ARTIS2-25H-2T	35	ATDA-8000-10-DCA	15	Freedom FWE(TA) 300	29
AHCTS-2.5K	20	APTH-14OE36	25	ARTIS2-25H-2TA	35	(-TA)(-TP)	15	Freedom FWE(TA) 400	29
AHCTS-3/4RDF	19	APTH-14OE38	25	ARTIS2-25H-5T	35	ATDA-DC	14	Freedom FWE(TA) 600	29
AHCTS-005K	20	APTH-14OE41	25	ARTIS2-25H-5TA	35	ATDBLIS	39	Freedom FWE(TA) 800	29
AHCTS-010K	20	APTH-14RT34	25	ARTIS2-25H-10T	35	ATDBRIS	39	Freedom FWE(TA) 1000	29
AHCTS-025K	20	APTH-14RT50	25	ARTIS2-25H-10TA	35	ATW-0100F	24	Freedom FWE(TA) 1200	29
AHCTS-0500	20	APTH-14SD50	25	ARTIS2-25H-20T	35	ATW-0200F	24	FTY	31
AHCTS-2500	20	APTW-25	25	ARTIS2-25H-20TA	35	ATW-0500F	24	FWE Cable DT.ET	39
AHCTS-7500	20	APTW-50	25	ARTIS2-25S-10T	35	ATW-1000F	24		
AHDTS-5025	20	APTW-100	25	ARTIS2-25S-10TA	35	ATWL-250	22	I-L	
AIMTS-0500	21	APTW-150	25	ARTIS2-25S-20T	35	ATWL-750	22	ICBL-4P	39
AIMTS-2000	21	APTW-200	25	ARTIS2-25S-20TA	35	ATWL-1000	22	ICBL-10P	39
AISF-200100	34	APTW-340	25	ARTIS2-38S-25T	35	Audit Manager	18	ICBL-8000DIG	39
AISF-200250	34	ARDA-XXX	36	ARTIS2-38S-25TA	35	AUET-10(-DC)	10	ICBL-USB	39
AISF-201000	34	ARDFA-100(HD)		ARTIS2-38S-75T	35	AUET-50(-DC)	10	iTVC	30
AISI-200025	34	(HDE)(HDS)	37	ARTIS2-38S-75TA	35	AUET-0100(-DC)	10		
AISI-200100	34	ARDFA-150(HD)		ARTIS2-50S-180T	35	AUET-250(-DC)	10	M-Q	
AISI-200500	34	(HDE)(HDS)	37	ARTIS2-50S-180TA	35	AUET-500(-DC)	10	MSB	31
AJKR-28	37	ARDFA-250(HD)		ARTIS2-75S-250T	35	AUET-1000(-DC)	10	R	
AJKR-135	37	(HDE)(HDS)	37	ARTIS2-75S-250TA	35	AUET-1200(-DC)	10	RMC Cable DT.ET	39
AJKR-271	37	ARDFA-600(HD)		ARTIS2-75S-500T	35	AUET/MTM-10-100		S	
AJKR-1017	37	(HDE)(HDS)	37	ARTIS2-75S-500TA	35	(-DC)	10	SQNET	32
AJKR-1695	37	ARDFA-XXX	36	ARTIS2-75S-750T	35	AUET/MTM-50-250		T	
AJKS-25D	37	ARDFA-XXXHDE	36	ARTIS2-75S-750TA	35	(-DC)	10	Tool Manager	18
AJKS-38D	37	ARDFA-XXXHDS	36	ARTIS2-100S-1400T	35	AUET/MTM-50-500		U	
AJKS-50D	37	ARDFA-XXXXHD	36	ARTIS2-100S-1400TA	35	(-DC)	10	UFT-24	38
AJKS-75D	37	ARDIA-10(HD)		ARTIS2-150S-3000T	35	AUET/MTM-100-500		UFT-S10	38
AJKS-100D	37	(HDE)(HDS)	37	ARTIS2-150S-3000TA	35	(-DC)	10	UFT-S16	38
APTH-12OE7	25	ARDIA-25(HD)		ARTIS2-150S-5000T	35	AUET/MTM-100-1000		V-Z	
APTH-12OE8	25	(HDE)(HDS)	37	ARTIS2-150S-5000TA	35	(-DC)	10	VPG	33
APTH-12OE9	25	ARDIA-100(HD)		ASTB-25S-2C	34	C			
APTH-12OE10	25	(HDE)(HDS)	37	ASTB-75R-10P	34	CA150108DHD	19		
APTH-12OE11	25	ARDIA-250(HD)		ASTB-75R-20P	34	CA1510	19		
APTH-12OE12	25	(HDE)(HDS)	37	ASTB-75R-50P	34	CA1550	19		
APTH-12OE13	25	ARDIA-500(HD)		ASTB-75R-100P	34	CA1575	19		
APTH-12OE14	25	(HDE)(HDS)	37	ASTB-75R-250P	34	CA2510I	19		
APTH-12OE15	25	ARDIA-XXX	36	ASTB-75R-500P	34	CA2515I	19		
APTH-12OE16	25	ARDIA-XXXHD	36	ASTB-75S-10C	34	CA2575I	19		
APTH-12OE17	25	ARDIA-XXXHDE	36	ASTB-75S-20C	34				
APTH-12OE18	25	ARDIA-XXXHDS	36	ASTB-75S-50C	34	D-E			
APTH-12OE19	25	ARTB-25H-2T(TA)	35	ASTB-75S-100C	34	DATAPRO	32		
APTH-12RT25	25	ARTB-25H-5T(TA)	35	ASTB-75S-250C	34	DataTouch3	17		
APTH-12RT38	25	ARTB-25H-20T(TA)	35	ASTB-75S-500C	34	F-H			
APTH-12RT50	25	ARTB-25S-10T(TA)	35	ASTB-100S-1000C	34	FRDM3-15	27		
APTH-12SD25	25	ARTB-25S-20T(TA)	35	ASTB-1000R-1000P	34	FRDM3-30	27		
		ARTB-38S-25T(TA)	35	ASTIS-25D-11	34				



Visit our *NEW* website
WWW.AIMCO-GLOBAL.COM

AIMCO CORPORATE HEADQUARTERS

10000 SE Pine Street
Portland, Oregon 97216
Phone: (503) 254-6600
Toll Free: 1-800-852-1368

AIMCO CORPORATION DE MEXICO SA DE CV

Ave. Cristobal Colon 14529
Chihuahua, Chihuahua. 31125
Mexico
Phone: (01-614) 380-1010
Fax: (01-614) 380-1019

AIMCO EUROPE

C/ Río Gallo, 431 urb. Montelar
19174 Galápagos / Guadalajara
Spain
Phone: +34 673 34 99 25

AIMCO CHINA

Room 607, No. 3998 Hongxin Rd
Minhang District, Shanghai
China
Phone: 0086-21-34319246
Fax: 0086-21-34319245

AIMCO SOUTH AMERICA

Carrera 29A, #7B-91. Origami Building. Int604
Medellin; Colombia 050021

TORQUE M