

TOOLS FOR LIGHT ASSEMBLY



AIMCO
WWW.AIMCO-GLOBAL.COM



For over 40 years AIMCO has been working with manufacturers around the world. We are the complete global source for all critical fastening and bolting solutions. AIMCO can effectively and swiftly meet your needs whether you're in Thailand fastening a 3 mm nut at 3 Nm, or in Tennessee, USA torquing the last lug nut. AIMCO provides the tools and solutions, on a global scale, that guarantee the success of your project. It is with great pride that AIMCO can say the products that we manufacture are **MADE IN THE USA.**

TABLE OF CONTENTS

POWER TOOLS

US-LT PNEUMATIC SCREWDRIVERS	3
ELECTRA® SERIES ELECTRIC SCREWDRIVERS	6
SIGNATURE SERIES® SHUT-OFF IMPACT CORDLESS TOOLS	9
SIGNATURE SERIES® PRECISION CLUTCH CORDLESS TOOLS.	10

TORQUE MEASUREMENT

APTW PRESET TORQUE WRENCHES	13
TORQUE MEASUREMENT TESTERS	14
RUNDOWN FIXTURES.	16
GRAVITY DEFYING BALANCERS	17

TOOL SUPPORT SYSTEMS

RETRACTORS	18
ERGO-ARM® TOOL SUPPORT SYSTEMS.	19
ERGO-ARM® ACCESSORIES & LINEAR ARMS	20
WORKSTATION COMPONENTS AND ASSEMBLIES.	21
AIR PREPARATION UNITS	23
AIR LINE	24
AIR LINE ACCESSORIES	25

US-LT PNEUMATIC SCREWDRIVERS

TORQUE CONTROL AUTOMATIC SHUT-OFF TYPE

- Precise repeatability improves quality
- Minimal wear on internal parts for longer life
- Quick shut off for minimum torque reaction
- Speed choice for flexibility
- Easy external torque adjustment
- Midrange air motor provides high speed during entire cycle
- Ideal for industrial torque control applications



US-LT30B Series



US-LT50B Series



US-LT10B



US-LT20B Series



US-LT40B Series

TORQUE CONTROL LIGHT TOUCH (LT) SERIES - PUSH-TO-START INLINE

Recommended Air Pressure: 85 psi

MODEL	TORQUE RANGE		FREE SPEED RPM	OVERALL LENGTH		WEIGHT		FROM CENTER TO OUTSIDE		NOISE LEVEL dB(A)	AIR USAGE CFM
	NM	IN-LB		MM	IN	LB	KG	MM	IN		
US-LT10B	0.2 - 0.6	1.8 - 5.3	1,000	191	7.5	0.6	0.3	12.0	0.5	75	5.2
US-LT20B-10	0.4 - 1.1	3.1 - 9.7	1,000	180	7.1	0.7	0.3	13.0	0.5	70	5.6
US-LT20B-18	0.3 - 0.7	2.2 - 6.2	1,800	180	7.1	0.7	0.3	13.0	0.5	70	5.6
US-LT30B-11	1.1 - 2.1	9.7 - 18.5	1,100	187	7.4	0.9	0.4	15.5	0.6	70	7.0
US-LT30B-17	0.7 - 1.5	6.2 - 13.2	1,700	187	7.4	0.9	0.4	15.5	0.6	70	7.0
US-LT30B-23	0.4 - 1.0	3.5 - 8.8	2,300	187	7.4	0.9	0.4	15.5	0.6	71	7.0
US-LT40B-08	1.6 - 4.0	14.1 - 35.2	800	209	8.2	1.4	0.7	16.5	0.6	70	10.5
US-LT40B-15	1.0 - 2.2	6.2 - 19.4	1,500	209	8.2	1.4	0.7	16.5	0.6	70	10.5
US-LT40B-21	1.0 - 1.7	6.2 - 15.0	2,100	209	8.2	1.4	0.7	16.5	0.6	74	10.5
US-LT50B-05	5.0 - 10.2	44.0 - 92.4	480	240	9.5	2.2	1.0	19.5	0.8	74	17.5
US-LT50B-08	3.0 - 5.5	26.4 - 48.4	800	240	9.5	2.2	1.0	19.5	0.8	75	17.5
US-LT50B-17	1.5 - 2.6	9.7 - 23.0	1,700	240	9.5	2.2	1.0	19.5	0.8	75	17.5

Air Hose Size: 1/4 I.D. for US-LT10B - US-LT40B Series - 3/8" I.D. for US-LT50B Series
Each model is equipped with its standard and alternate clutch springs

Air Inlet: 1/8 for US-LT10B - US-LT20B Series - 1/4" for US-LT30B - US-LT50B Series

EXTERNAL TORQUE ADJUSTMENT (AIR SHUT-OFF)

Set the hand driver into the key hole on the Adjusting Gear, turn clockwise to increase torque. Turn counter clockwise to decrease torque.

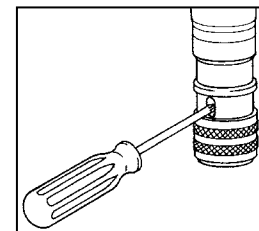

US-LT PNEUMATIC SCREWDRIVERS



US-LT30B_C Series



US-LT40B_C Series



US-LT40_C Series



US-LT30BL Series



US-LT40BL Series

TORQUE CONTROL LIGHT TOUCH (LT) SERIES - ANGLE AND LEVER

Recommended Air Pressure: 85 psi

MODEL	TORQUE RANGE (SOFT JOINT)		FREE SPEED RPM	OVERALL LENGTH		WEIGHT		FROM CENTER TO OUTSIDE		HEX BIT OR DRIVE SIZE IN	NOISE LEVEL dB(A)	AIR USAGE CFM
	NM	IN-LB		MM	IN	LB	KG	MM	IN			
ANGLE												
US-LT30B-11C	1.1 - 2.1	3.5 - 18.5	1,100	298	10.7	1.5	0.7	36	1.4	1/4	73	7.0
US-LT30B-17C	0.7 - 1.5	3.5 - 13.2	1,700	295	10.7	1.5	0.7	36	1.4	1/4	73	7.0
US-LT40B-03C	5.0 - 10.0	44 - 88	300	359	14.2	2.4	1.1	35.5	1.4	3/4	72	10.5
US-LT40B-05C	2.3 - 5.7	20.0 - 49.5	500	322	13.0	2.1	0.9	38.5	1.5	1/4	75	10.5
US-LT40B-08C	1.6 - 4.0	8.7 - 34.7	800	320	12.8	2.0	0.9	36	1.4	1/4	75	10.5
US-LT40B-15C	1.0 - 2.2	8.7 - 19.4	1,500	320	12.8	2.0	0.9	36	1.4	1/4	75	10.5
US-LT40-03C	5.0 - 10.0	43.4 - 86.8	300	360	14.2	2.4	1.1	35.5	1.4	1/4 Sq.	72	10.5
US-LT40-05C	2.3 - 5.7	20.0 - 50.2	500	322	13.0	2.1	0.9	35.5	1.4	1/4 Sq.	75	10.5
US-LT40-08C	1.6 - 4.0	8.7 - 34.7	800	320	12.8	2.0	0.9	32	1.3	1/4 Sq.	75	10.5
LEVER												
US-LT30BL-11	1.1 - 2.1	9.7 - 18.5	1,100	229	8.2	1.2	0.5	15	0.6	1/4	70	5.2
US-LT30BL-17	0.7 - 1.5	6.2 - 13.2	1,700	229	8.2	1.2	0.5	15	0.6	1/4	70	5.2
US-LT40BL-08	1.6 - 4.0	14.1 - 35.2	800	249	9.8	1.5	0.7	17	0.7	1/4	70	5.6
US-LT40BL-15	1.0 - 2.2	8.8 - 19.4	1,500	249	9.8	1.5	0.7	17	0.7	1/4	70	5.6

Angle Head Height: 32 - 36mm

Air Inlet: N.P.T. 1/4"

Air Hose Size: 1/4" I.D. for all models



US-LT31PB Series



US-LT41PB Series



US-LT51PB Series



US-LT60P Series

TORQUE CONTROL LIGHT TOUCH (LT) SERIES - PISTOL

Recommended Air Pressure: 85 psi

MODEL	TORQUE RANGE (SOFT JOINT)		FREE SPEED RPM	OVERALL LENGTH		WEIGHT		FROM CENTER TO OUTSIDE		NOISE LEVEL dB(A)	AIR USAGE CFM
	NM	IN-LB		MM	IN	LB	KG	MM	IN		
US-LT31PB-05	2.4 - 5.0	21.1 - 44.0	500	189	8.2	1.9	0.9	16	0.6	70	7.0
US-LT31PB-11	1.1 - 2.1	9.7 - 18.5	1,100	170	7.0	1.6	0.7	16	0.6	70	7.0
US-LT31PB-17	0.7 - 1.5	6.2 - 13.2	1,700	170	7.0	1.6	0.7	16	0.6	70	7.0
US-LT31PB-23	0.4 - 1.0	3.5 - 8.8	2,300	170	7.0	1.6	0.7	16	0.6	70	7.0
US-LT41PB-08	1.6 - 4.0	14.0 - 35.2	800	175	7.7	1.9	0.9	17	0.6	70	10.5
US-LT41PB-15	1.0 - 2.2	8.8 - 19.4	1,500	175	7.7	1.9	0.9	17	0.6	70	10.5
US-LT41PB-21	1.0 - 1.7	8.8 - 15.0	2,500	175	7.7	1.9	0.9	17	0.6	74	10.5
US-LT51PB-05	5.0 - 10.5	44.0 - 92.4	480	198	8.5	2.6	1.2	20	0.8	74	17.5
US-LT51PB-08	3.0 - 5.5	26.4 - 48.4	800	198	8.5	2.6	1.2	20	0.8	75	17.5
US-LT51PB-17	1.5 - 2.6	13.2 - 22.9	1,700	198	8.5	2.6	1.2	20	0.8	75	17.5
US-LT60P-03*	7.0 - 20.0	61.6 - 176.0	320	230	9.1	3.7	1.7	22	0.9	75	21.0
US-LT60P-07*	4.0 - 10.0	35.2 - 88.0	650	230	9.1	3.7	1.7	22	0.9	76	21.0
US-LT60P-11*	4.0 - 7.0	35.2 - 61.6	1,100	230	9.1	3.7	1.7	22	0.9	77	21.0

Air Hose Size: 1/4 I.D. for US-LT31PB & US-LT41PB Series

Air Inlet: N.P.T. 1/4"

3/8 I.D. for US-LT31PB-05, US-LT51PB Series & US-LT60P Series

* Optional 3/8" Sq. Drive available for US-LT60P Series ADD (P) to Model Number



US-LT PNEUMATIC SCREWDRIVER ACCESSORIES



OPTIONAL CLUTCH SPRINGS

MODEL	CLUTCH SPRINGS PROVIDED		RECOMMENDED TORQUE RANGE HARD JOINT		CLUTCH SPRING CODE NUMBER
	Standard	Option	Nm	in-lb	
US-LT10B	Black		0.20 - 0.60	1.7 - 5.2	976-379-0
US-LT20B-10	Black		0.34 - 1.10	3.0 - 9.5	976-432-0
		Red	0.20 - 0.70	1.7 - 6.1	976-431-0
		Yellow	0.15 - 0.34	1.3 - 3.0	976-430-0
US-LT20B-18	Red		0.24 - 0.67	2.2 - 6.1	976-431-0
		Yellow	0.15 - 0.34	1.3 - 3.0	976-430-0
US-LT20B-26	Yellow		0.15 - 0.34	1.3 - 3.0	976-430-0
US-LT31PB-05	Red		2.35 - 5.00	20.9 - 44.0	976-493-0
		Pink	0.98 - 2.74	8.7 - 24.3	976-471-0
US-LT30 Series, 1100 rpm	Blue		0.98 - 2.1	8.7 - 18.5	976-472-0
		Red	0.67 - 1.76	6.1 - 15.6	976-493-0
		Pink	0.39 - 0.98	3.5 - 8.7	976-471-0
		(not included)	1.22 - 2.74	10.8 - 24.3	976-504-0
US-LT30 Series, 1700 rpm	Red		0.67 - 1.47	6.1 - 13.0	976-493-0
		Pink	0.39 - 0.98	3.5 - 8.7	976-471-0
US-LT30 Series, 2300 rpm	Pink		0.39 - 0.98	3.5 - 8.7	976-471-0
US-LT40-03C	Red		4.90 - 9.80	43.4 - 86.8	976-516-0
US-LT40 Series, 800 rpm	Black		1.57 - 3.92	13.9 - 34.7	976-515-0
		Red	0.98 - 2.17	8.7 - 19.1	976-516-0
		Yellow	0.98 - 1.67	8.7 - 14.8	976-517-0
US-LT40 Series, 1500 rpm	Red		0.98 - 2.17	8.7 - 19.1	976-516-0
		Yellow	0.98 - 1.67	8.7 - 14.8	976-517-0
US-LT40 Series, 2100 rpm	Yellow		0.98 - 1.67	8.7 - 14.8	976-517-0
US-LT50 Series, 500 rpm	Black		4.9 - 10.3	43.4 - 91.1	976-620-0
		Red	2.9 - 5.4	26.1 - 47.7	976-614-0
		Yellow	1.4 - 2.5	13.0 - 22.6	976-588-0
US-LT50 Series, 800 rpm	Red		2.7 - 5.4	24.3 - 47.7	976-614-0
		Yellow	1.4 - 2.5	13.0 - 22.6	976-588-0
US-LT50 Series, 1700 rpm	Yellow		1.4 - 2.6	13.0 - 23.0	976-588-0



408-088-2

SILENCER ASSEMBLIES

MODEL	DIRECT TYPE SILENCER	LEADER HOSE ASSEMBLY	EXHAUST HOSE ASSEMBLY
US-LT10 Series	N/A	934-201-0	459-885-1
US-LT20 Series	N/A	934-201-0	455-885-1
US-LT30 Series	408-088-2	934-150-0	408-885-0
US-LT40 Series	496-088-1	934-150-0	-

ELECTRIC SCREWDRIVERS

ELECTRA[®] SERIES

- Available in push-to-start and lever start styles
- Ergonomic design – Lightweight, compact housings ensure operator comfort during operation
- Accurate torque control – Precise controlled fastening with automatic shut-off clutches
- External brush replacement – Virtually no down time for brush replacement
- External torque adjustment – Torque level can be easily adjusted by simply turning the external adjustment ring



AE-5681



- UL Listed and CE Certified – Drivers meet electrical safety standards in both the U.S. and Europe
- Direct plug-in style – Offers easy and convenient start-up (certain models), simply plug it in
- State-of-the-art motor design – Ensures comfortable grip temperature for operator and extended motor life

ELECTRA[®] SERIES

MODEL	TORQUE RANGE		FREE SPEED RPM	WEIGHT		LENGTH		HEX DRIVE		POWER SOURCE
	IN-LB	KGF-CM		LB	KG	IN	MM	IN	MM	
PUSH-TO-START DIRECT PLUG-IN SERIES										
AE-5681 (Includes torque cover)	3.5 - 15.6	4 - 18.0	1,000	1.2	0.5	9.3	237	1/4	6.4	115V AC*
AE-8681 (Includes pistol grip handle adapter)	15 - 45	23.0 - 51.8	600	1.6	0.7	10.6	269	1/4	6.4	115V AC*
LOW-VOLTAGE LEVER START SERIES (Requires External Power Supply)										POWER SUPPLY:
AE-2020	.35 - 1.3	.40 - 1.5	720	0.7	0.3	8.0	203	1/4	6.4	See page 8 for required power supplies
AE-4020	.9 - 5	1.0 - 6.0	720	0.7	0.3	8.0	203	1/4	6.4	
AE-4520	1.3 - 8.7	1.5 - 10.0	720	0.7	0.3	8.0	203	1/4	6.4	
AE-7010	6.1 - 17.4	7.0 - 20.0	750	1.4	0.6	9.3	236	1/4	6.4	
AE-8010	10.4 - 26.0	12.0 - 29.9	550	1.4	0.6	9.3	236	1/4	6.4	
LOW-VOLTAGE PUSH-TO-START SERIES (Requires External Power Supply)										POWER SUPPLY:
AE-7010PS	6.1 - 17.4	7.0 - 20.0	750	1.4	0.6	9.3	236	1/4	6.4	See page 8 for power supplies
AE-8010PS	10.4 - 26.0	12.0 - 29.9	550	1.4	0.6	9.3	236	1/4	6.4	

* 220V AC is available upon request. Contact AIMCO at 1-503-254-6600, or toll free 1-800-852-1368.

ELECTRA[®] LOW ESD SERIES

- Grounded bit – Grounded chuck assembly routes any existing charge to ground
- Carbonized housing – Handle material and buttons are constructed of carbonized plastic throughout, enabling any charge received by the handle to be routed to ground
- Long-Lasting ESD resistant handle – Material will maintain its integrity for the life of the handle, unlike coatings or paints



AE-5681ESD



ELECTRA[®] LOW ESD SERIES

MODEL	TORQUE RANGE		FREE SPEED RPM	WEIGHT		LENGTH		HEX DRIVE		POWER SOURCE
	IN-LB	KGF-CM		LB	KG	IN	MM	IN	MM	
AE-4520ESD*	1.3 - 8.7	1.5 - 10.0	720	0.9	0.4	8.0	204	1/4	6.4	35V DC
AE-5681ESD	3.5 - 15.6	4 - 18.0	1,000	1.2	0.5	9.3	237	1/4	6.4	115V AC**

* Low-voltage units require an external power supply.

** 220V AC is available upon request. Contact AIMCO at 1-503-254-6600, or toll free 1-800-852-1368.

ELECTRIC SCREWDRIVERS

ELECTRA® SLIP CLUTCH SERIES

- High-speed performance – For quick and consistent assembly and disassembly
- Maximum ergonomics and convenience – Offers a combination of a slip clutch with a high speed motor to provide low torque reaction; one of the best power-to-weight ratios in the industry
- Added maintenance feature – LED light indicates when to change brushes. Brush cap contains a switch that shuts off the power during brush replacement
- Direct 110V plug-in – Eliminates the need for an external power supply



AE-2015



- 1/4" hex quick change chuck for easy bit changes
- External torque collar for easy torque adjustment.

ELECTRA® SLIP CLUTCH SERIES

MODEL	RECOMMENDED TORQUE RANGE		FREE SPEED RPM	WEIGHT		LENGTH		HEX DRIVE		POWER SOURCE
	IN-LB	KGF-CM		LB	KG	IN	MM	IN	MM	
AE-2015	4.3 - 21.7	5.0 - 25.0	1,000	1.2	.55	9.2	234	1/4	6.4	110 V / 120V AC*

** 220V AC is available upon request. Contact AIMCO at 1-503-254-6600, or toll free 1-800-852-1368.

PRECISION SERIES

For low torque applications

- Featuring ergonomic design
- Comes with options such as long-life brushless motors and adjustable speed power supplies

STANDARD MODELS

- Optional speed control power supply – Enables infinite control from 20% to 100% of maximum tool speed and adjustable soft start to minimize cross threading
- Ergonomic housing – Oval shape conforms to hand
- Duralite – Casing material provides a secure grip
- Integrated Lever – Feather touch integrated lever reduces travel and stress. Requires only 2 mm of travel to activate
- External torque control – Twist and go

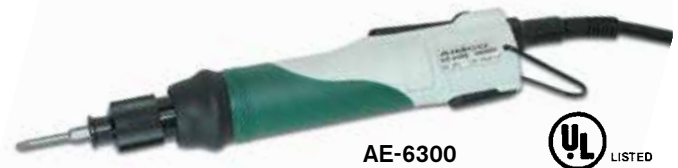

AE-6300
AE-6450



EXTENDED LIFE MODELS

- Sealed Swiss motor – For higher duty cycles, longer life, and less maintenance. Sealed casing means no brush changes are necessary
- Extended warranty on tool motor – Three year standard motor warranty
- Compact power supply – Makes setup a breeze

PRECISION SERIES

MODEL	TORQUE RANGE		FREE SPEED RPM	WEIGHT		LENGTH		HEX DRIVE IN
	IN-LB	KGF-CM		LB	KG	IN	MM	
STANDARD								
AE-6300	.85 - 5.0	1.0 - 5.8	725	0.9	0.4	8.5	216	1/4
AE-6450	1.3 - 8.7	1.5 - 10.0	770	0.9	0.4	8.5	216	1/4
HIGH SPEED								
AE-6300S	.35 - 4.3	0.4 - 5.0	920	0.9	0.4	8.5	216	1/4
AE-6450S	1.3 - 8.7	1.5 - 10.0	920	0.9	0.4	8.5	216	1/4
EXTENDED LIFE								
AE-6300M	1.0 - 5.5	1.1 - 6.3	550	0.9	0.4	8.5	216	1/4

ELECTRIC SCREWDRIVERS

ELECTRA® SERIES ACCESSORIES - POWER SUPPLIES



AE-224PS
AE-278PS



APM-30

MODEL	COMPATIBLE SCREWDRIVERS	TOOL RPM	VOLTAGE CONVERSION	DIMENSIONS	WEIGHT LB	KG
AE-224PS	AE-2020 AE-2020ESD AE-4020 AE-4520 AE-4520ESD	720	110V AC - 220V AC 35V DC	2.6 x 1.6 x 5.0 66 x 41 x 127 mm	1.0	.45
AE-278PS	AE-7010 AE-7010PS	STANDARD	110V AC - 220V AC 30V DC	1.6 x 5.0 x 2.6 41 x 127 x 66 mm	1.0	.45
APM-30	AE-6300M	550	110V AC - 220V AC 30V DC	2.1 x 3.4 x 1.9 53 x 87 x 48 mm	0.4	0.2

DIGITAL FASTENING COUNTER



The AM Series fastener counter verifies and error-proofs the assembly process.

- Buzzer notifies of missing screws, incomplete fastening, and thread damage
- Counts up to 60,000 units and up to 99 screws per unit
- Connects easily to automation equipment using standard input/output signals
- Large LCD screen is easy to read. A green screen indicates OK fastening, a red screen indicates NG

MODEL	COMPATIBLE SCREWDRIVERS
AM-45	For AE-2020, AE-4020, AE-4520 Standard and ESD types
AM-65	For AE-7010, AE-7010PS, AE-8010 and AE-8010PS

OPTIONAL ACCESSORIES



ANGLE HEAD ATTACHMENTS

Available for lever start series. Not available for Low ESD Series.



PISTOL GRIP HANDLE

Converts to a pistol style driver for horizontal fastening. Available for Trigger Start only (included with AE-8681).



TORQUE COVER

Prevents accidental torque adjustment by the operator (included with AE-5681).

ITEM	MODEL	COMPATIBLE SCREWDRIVERS
Angle Head Attachments	AE-2045A AE-7080A	For AE-2020, AE-4020, AE-4520 For AE-7010, AE-8010
Pistol Grip Handle	AE-PG7080	For AE-7010, AE-7010PS, AE-8010, AE-8010PS
Torque Cover	AE-TC2040 AE-TC7080 4H2055	For AE-2020, AE-4020, AE-4520 For AE-7010, AE-7010PS, AE-8010, AE-8010PS For AE-8681

Tested and **PROVEN** to **BEAT** the competition in vibration and noise levels. These tools outperform the competition in number of rundowns per battery charge.



SHUT-OFF IMPACT TOOLS

The **Signature Series** Impact Shut-Off Pistol Tool can operate as a standard impact wrench or as an impact wrench with a programmable shut-off point, preventing over-torquing. These innovative tools deliver a torque range of 3–120 Nm (2–89 ft-lb). No torque reaction, coupled with the ergonomic, lightweight design and reduced vibration, helps to prevent user injury.



SIW-P5538

FEATURES AND BENEFITS

- Brushless motor provides longer motor life and increased efficiency
- Easy-to-read process information lights
- Advanced shut-off system
- LED light for work-area illumination
- Programmable buttons for easy operation
- Li-Ion battery provides long battery life
- Mini USB port for connection to optional programmer (SPC-2PGM)

MODEL	TORQUE RANGE		MAX TORQUE		FREE SPEED	BATTERY		WEIGHT		ANVIL SIZE	NOISE LEVEL dB(A)
	NM	FT-LB	NM	FT-LB		(V)	LB	KG			
SIW-P2525Q	3 - 25	2 - 18	40	30	2,400	20	2.2	1	1/4 QC	71	
SIW-P3225Q	6 - 32	4 - 24	90	66	2,400	20	2.2	1	1/4 QC	71	
SIW-P3238	6 - 32	4 - 24	90	66	2,400	20	2.2	1	3/8 Sq Dr	71	
SIW-P5538	15 - 55	11 - 41	120	90	2,400	20	2.4	1.1	3/8 Sq Dr	71	
SIW-P5550	15 - 55	11 - 41	120	90	2,400	20	2.4	1.1	1/2 Sq Dr	71	
SIW-P10050	25 - 100	18 - 74	180	133	2,400	20	2.4	1.1	1/2 Sq Dr	71	
SIW-P12050	30 - 120	22 - 89	210	155	2,400	20	2.9	1.3	1/2 Sq Dr	71	

Shut-Off Impact Tools Include: Body Jacket, Bail, and one (1) 18V Li-Ion Battery

BATTERY AND CHARGER

The **Signature Series** Shut-Off Impact Tool battery features a slim profile design and a slide mount connection to the tool, which ensures durability and makes changing out batteries quick and easy.

BATTERY MODEL #	VOLTAGE / CAPACITY	TYPE
SIW-B20LI	20V, 2.0 Ah	Li-Ion
SIW-B20LI-HC	20V, 4.0 Ah	Li-Ion
CHARGER MODEL #	OUTPUT	INPUT
SIW-C18-20	18 - 20V, 4.0 A	100 - 240VAC, 50-60 Hz



SIW-B20LI

SIW-B20LI-HC



SIW-C18-20

ACCESSORIES

MODEL #	DESCRIPTION
BJ10091	Grey Body Jacket Cover
SIW-PBL	Suspension Bail
SIW-38PR	Pin Retainer Kit, 3/8" Drive
SIW-50PR	Pin Retainer Kit, 1/2" Drive



BJ10091



SIW-PBL

Quick shut-off, precision clutch minimizes torque reaction and ensures precise application of torque.

PRECISION CLUTCH TOOLS

Signature Series precision clutch tools feature a quick-releasing clutch that delivers accuracy across multiple joint types. Constructed of precision machined parts, this tool guarantees accuracy and durability over the life of the tool.

FEATURES AND BENEFITS

- LED indicator provides simple process information to the operator. The signal is visible from any angle
- Press button for easy F/R operation
- LED light for working in dark areas
- Trigger repeat protection avoids double hits on already seated screws
- Easily attached sliding battery system
- Mini USB port for connection to optional programmer (SPC-2PGM)
- Li-Ion battery pack delivers longer run time
- Ergonomic handle design provides outstanding balance and weight and is ideal for accessing hard-to-reach locations
- Angle tool enables multiple head positions



SPC-P2325Q



SPC-A21625

MODEL	TORQUE RANGE		FREE SPEED RPM RANGE (PROGRAMMABLE WITH PROGRAMMER ACCESSORY)	BATTERY VOLTAGE	TOOL WEIGHT (W/O BATTERY)		ANVIL SIZE
	NM	FT-LB			LB	KG	
Pistol Grip*							
SPC-P2325Q	8 - 3	6 - 2.2	500 - 1,550	18V	2.1	.95	1/4" hex
SPC-P2625Q	1 - 6	.7 - 4.4	300 - 1,000	18V	2.1	.95	1/4" hex
SPC-P2925Q	1.5 - 9	1.1 - 6.6	300 - 800	18V	2.1	.95	1/4" hex
SPC-P21225Q	2 - 12	1.5 - 8.8	250 - 600	18V	2.1	.95	1/4" hex
Right Angle Nutrunner**							
SPC-A21025Q	3 - 12	2.2 - 8.8	400 - 1,000	18V	3.5	1.6	1/4" hex
SPC-A21025	3 - 12	2.2 - 8.8	400 - 1,000	18V	3.5	1.6	1/4" Sq
SPC-A21038	3 - 12	2.2 - 8.8	400 - 1,000	18V	3.5	1.6	3/8" Sq
SPC-A21625Q	5 - 18	3.7 - 13.3	300 - 600	18V	3.5	1.6	1/4" hex
SPC-A21625	5 - 18	3.7 - 13.3	300 - 600	18V	3.5	1.6	1/4" Sq
SPC-A21638	5 - 18	3.7 - 13.3	300 - 600	18V	3.5	1.6	3/8" Sq
SPC-A23038	8 - 30	5.9 - 22	250 - 480	18V	3.5	1.6	3/8" Sq
SPC-A23538	10 - 35	7.4 - 25.8	220 - 330	18V	3.5	1.6	3/8" Sq
SPC-A25038	10 - 50	7.4 - 37	200 Non-Programmable Fixed Speed***	18V	5.3	2.4	3/8" Sq
SPC-A27038	20 - 70	14.8 - 51.7	170 Non-Programmable Fixed Speed***	18V	6.3	2.9	3/8" Sq
SPC-A210050	35 - 100	26 - 74	119 Non-Programmable Fixed Speed***	18V	7.4	3.4	1/2" Sq

* Pistol Grip Tools include: Torque Adjustment Tool and one (1) 18V Li-Ion Battery

** Angle Nutrunners include: Torque Adjustment Tool, Head Indexing Spanner Wrench, and one (1) 18V Li-Ion Battery

*** High torque tools feature fixed RPM

BATTERY AND CHARGER

The AIMCO **Signature Series** Precision Clutch Tool battery and charging system could not be more simple. One universal battery and charger interface with all of the **Signature Series** Precision Clutch tools. Each tool utilizes the same lightweight 18V Li-Ion battery, which provides superior battery life. The charger accepts input AC power of 100–240VAC, making use simple anywhere in the world.



SPC-B218LI



SPC-C218-19

BATTERY MODEL #	VOLTAGE	TYPE	CAPACITY	WEIGHT
SPC-B218LI	18V	Li-Ion	2.0 Ah	.8 Lb/.4 kg
SPC-B218LI-HC	18V	Li-Ion	4.0 Ah	1.4 Lb/.64 kg
CHARGER MODEL #	OUTPUT	INPUT	DIMENSIONS (W/O BATTERY)	WEIGHT
SPC-C218-19	18V-19.2V 3.0 A	100-240VAC 50-60 Hz	6.25" deep x 5" wide x 3.5" tall 158.75 mm x 127 mm x 89 mm	1.2 Lb/.54 kg

PRECISION CLUTCH TOOL ATTACHMENTS

A wide variety of special heads and attachments can be fitted to Signature Series Angle Nutrunners. Contact your AIMCO representative for assistance, 1-503-254-6600, or toll free 1-800-852-1368.

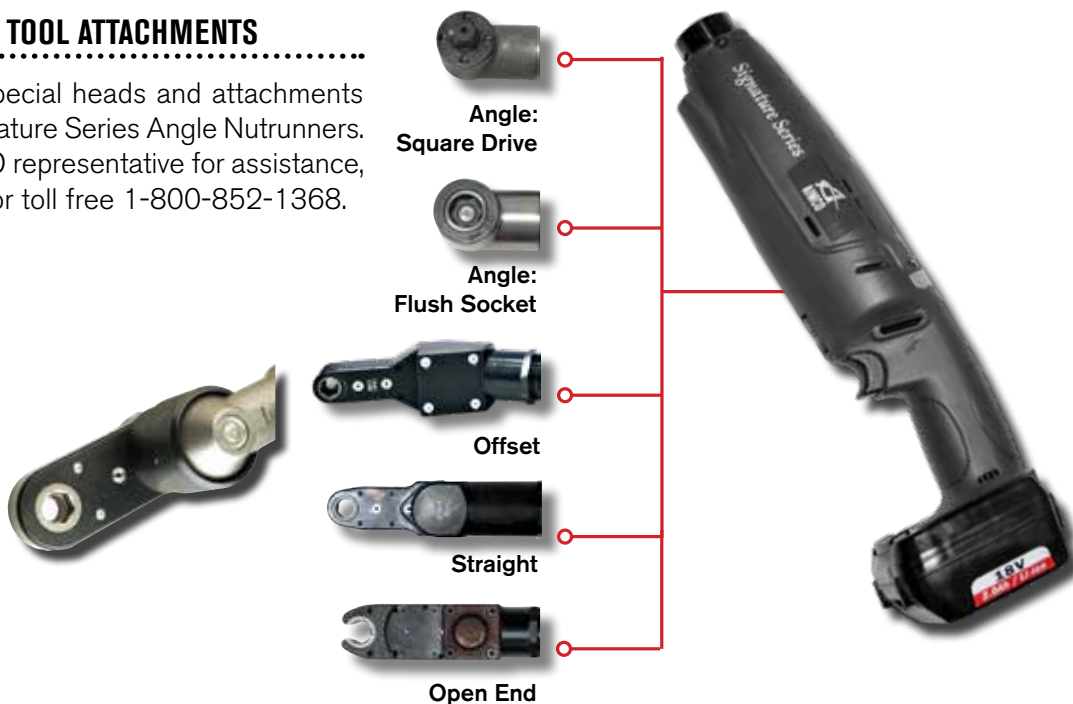

QUICK CLIP

The two piece Quick Clip comes with a belt clip and a stretch cord attachment for the Signature Series Precision Clutch pistol tool. The patented ball feature allows for quick and easy release.

SPC-QC

BODY JACKETS

Prevent damage to the workpiece.

MODEL	DESCRIPTION
 BJ10082	Clear Body Jacket for Signature Series Precision Clutch Pistol Tools
 BJ10083	Clear Body Jacket for Signature Series Precision Clutch Angle Nutrunners

TOOL SPEED PROGRAMMER

Each **Signature Series** battery tool has programmable features that enhance operator efficiency. Programmable features include:

- Tool speed control from minimum (1,500 rpm) to maximum (2,400 rpm) speed in 50 rpm increments
- Forward/Reverse Mode - Three setting options
- Two-stage trigger delay control
- Screw count / impact count
- Supervisor level "lock-out" control

Additionally, the **Signature Series** battery tool has an integrated mini USB connector that couples to the **Signature Series** Programmer module. Simply connect the tool to the Programmer Module and flash the tool to the desired RPM. The programmed RPM will remain until a change is desired.



SPC-2PGM

HOLSTERS



AIMCO offers right-hand and left-hand holsters for pistol and right angle tools.

SPC-P-HL-LH for Left Hand
SPC-P-HL-RH for Right Hand

TOOL BASKETS



AIMCO tool baskets can be affixed to a bench or rack and can be used for either a pistol or right angle tool.

Signature Series

Signature Series tools can be adapted to a wide range of application-specific configurations.
Contact your AIMCO Customer Service Associate for assistance, 1-503-254-6600, or toll free 1-800-852-1368.



AUDITOR PRESET TORQUE WRENCHES

Auditor's APTW preset wrenches provide a flexible, easy way to audit fastener torque. A wide range of interchangeable heads provide flexibility and convenience.



FEATURES AND BENEFITS



- Easy-to-use preset wrenches for fastener torque auditing
- Torque ranges from 5 – 340 Nm
- User friendly, sleek, ergonomic design
- Tactile feedback on achievement of preset torque
- Proprietary adjustment tool guards against unauthorized setting changes
- Wide range of interchangeable heads provide flexibility and convenience
- +/- 3% accuracy when used in clockwise or counterclockwise directions









WRENCH MODEL	TORQUE RANGE	INSERT ACCEPTED
APTW-25	5 – 25 Nm	12 mm
APTW-50	10 – 50 Nm	12 mm
APTW-100	20 – 100 Nm	12 mm
APTW-150	30 – 150 Nm	12 mm
APTW-200	40 – 200 Nm	14 mm
APTW-340	60 – 340 Nm	14 mm

TORQUE WRENCH INSERTS

ADAPTERS	DESCRIPTION
 APTH-12ADP	9 x 12 M to 14 x 18 F
 APTH-14ADP	14 x 18 M to 9 x 12 F

RING END INSERTS	DESCRIPTION
 APTH-12RE50	1/2" Ring End, 12 mm
 APTH-14RE32	32 mm Ring End, 14 mm

SQUARE DRIVE INSERTS	DESCRIPTION
9 x 12	
 APTH-12SD25	1/4" Sq. Dr.
 APTH-12SD38	3/8" Sq. Dr.
 APTH-12SD50	1/2" Sq. Dr.
14 x 18	
 APTH-14SD50	1/2" Sq. Dr.

BLANK END INSERTS	DESCRIPTION
 APTH-12BLANK	12 mm
 APTH-14BLANK	14 mm

RATCHET HEADS	DESCRIPTION
9 x 12	
 APTH-12RT25	1/4" Sq. Dr.
 APTH-12RT38	3/8" Sq. Dr.
 APTH-12RT50	1/2" Sq. Dr.
14 x 18	
 APTH-14RT50	1/2" Sq. Dr.
 APTH-14RT34	3/4" Sq. Dr.

OPEN END HEAD INSERTS							
		MODEL	DESCRIPTION	MODEL	DESCRIPTION	MODEL	DESCRIPTION
	9 x 12			14 x 18			
	APTH-120E7	7 mm OE	APTH-140E1	1" OE	APTH-140E25	25 mm OE	
	APTH-120E8	8 mm OE	APTH-140E13	13 mm OE	APTH-140E27	27 mm OE	
	APTH-120E9	9 mm OE	APTH-140E14	14 mm OE	APTH-140E30	30 mm OE	
	APTH-120E10	10 mm OE	APTH-140E15	15 mm OE	APTH-140E32	32 mm OE	
	APTH-120E11	11 mm OE	APTH-140E16	16 mm OE	APTH-140E34	34 mm OE	
	APTH-120E12	12 mm OE	APTH-140E17	17 mm OE	APTH-140E36	36 mm OE	
	APTH-120E13	13 mm OE	APTH-140E18	18 mm OE	APTH-140E38	38 mm OE	
	APTH-120E14	14 mm OE	APTH-140E19	19 mm OE	APTH-140E41	41 mm OE	
	APTH-120E15	15 mm OE	APTH-140E21	21 mm OE	APTH-140E118	1-1/8" OE	
	APTH-120E16	16 mm OE	APTH-140E22	22 mm OE	APTH-140E138	1-3/8" OE	
	APTH-120E17	17 mm OE	APTH-140E24	24 mm OE			
	APTH-120E18	18 mm OE					
	APTH-120E19	19 mm OE					
	APTH-120E20	20 mm OE					
	APTH-120E50	1/2" OE					

AUDITOR TORQUE CUBE



ATC-10
ATC-25
ATC-100
ATC-250
ATC-500
ATC-750
ATC-1800



ATC-150F
ATC-250F
ATC-500F
ATC-750F



AUDITOR TORQUE CUBE

The Auditor Torque Cube (ATC) is a compact, versatile desktop tester that provides a multitude of capabilities. The ATC is designed to test hand or power tools with the following:

- Peak, first peak, and track modes
- Multiple engineering units
- Manual and auto clear function
- Multiple frequency response settings
- Bi-directional use and accuracy
- Accuracy is better than 1% of indicated reading top 90% of range
- Serial data output
- Memory: 999 data samples
- Battery and/or mains powered

Because precision and quality are critical, you can depend on our testers to calibrate and certify your tools. Whether you are assembling large complicated systems or small precise time pieces, AIMCO provides the best system for your application. Our instruments have been judged “best in class” by independent National Standards laboratories. Auditor Torque Cube is rugged enough to test and verify tools at “point of use” while still being accurate enough to calibrate hand and power tools.

Each tester is shipped with a mains/battery charger power cord, a hex to allen drive bit, and a bolting template. Models with max torque of 1,000 in-lb or less also include a joint rundown fixture. The ATC can be positioned vertically or horizontally for the ergonomic testing of inline or pistol grip tools.

MODEL	RECOMMENDED TORQUE RANGE		WEIGHT		W X H X D		SQUARE DRIVE IN
	NM	IN-LB/FT-LB	KG	LB	MM	IN	
Vertical Configuration							
ATC-10	0.13 - 1.13	1 - 10 in-lb	1.13	2.5	79 x 95 x 83	3.13 x 3.75 x 3.25	1/4
ATC-25	0.28 - 2.83	2.5 - 25 in-lb	1.13	2.5	79 x 95 x 83	3.13 x 3.75 x 3.25	1/4
ATC-100	1.13 - 11.3	10 - 100 in-lb	1.13	2.5	79 x 95 x 83	3.13 x 3.75 x 3.25	1/4
ATC-250	2.83 - 28.3	25 - 250 in-lb	1.13	2.5	79 x 95 x 83	3.13 x 3.75 x 3.25	3/8
ATC-500	5.65 - 56.5	50 - 500 in-lb	1.13	2.5	79 x 95 x 83	3.13 x 3.75 x 3.25	3/8
ATC-750	8.47 - 84.8	75 - 750 in-lb	1.13	2.5	79 x 95 x 83	3.13 x 3.75 x 3.25	3/8
ATC-1800	21.2 - 203	188 - 1,800 in-lb	1.13	2.5	79 x 95 x 83	3.13 x 3.75 x 3.25	1/2
Horizontal Configuration							
ATC-150F	20 - 200	15 - 150 ft-lb	2.25	5	79 x 95 x 83	3.13 x 3.75 x 3.25	1/2
ATC-250F	34 - 340	25 - 250 ft-lb	2.25	5	79 x 95 x 83	3.13 x 3.75 x 3.25	1/2
ATC-500F	68 - 678	50 - 500 ft-lb	2.25	5	79 x 95 x 83	3.13 x 3.75 x 3.25	3/4
ATC-750F	102 - 1,017	75 - 750 ft-lb	2.25	5	79 x 95 x 83	3.13 x 3.75 x 3.25	3/4

AUDITOR BENCH-MOUNT TESTERS



AUET



AUET/MTM



AUET/MTM-DC

AUDITOR UNIVERSAL ELECTRONIC TESTERS

Auditor Universal Electronic Testers (AUET) have a broad range of features to accommodate most requirements. They are designed to be bench-top mounted and are available in several configurations and various single or multiple torque ranges. Onboard memory allows you to capture 999 torque event readings. The testers are also available in file capability (DC) models that require PC software Auditor Tool Manager (ATM).

Instruments up to 1,000 in-lb are supplied with rundown adapters/joint kits. Rundown kits for larger instruments can be ordered separately. AUET/MTM units are supplied with an external transducer port and selector switch for connecting additional transducers.

AUET testers utilize the same transducers as the ATC instruments, providing the same high quality accuracy and durability. The common interface makes the Auditor tester extremely user friendly.



SINGLE TRANSDUCER MODELS

MODEL*	RECOMMENDED TORQUE RANGE	
	KGF-CM/NM	IN-OZ/IN-LB
AUET-050(-DC)	0.4 - 3.6 kgf-cm	5 - 50 in-oz
AUET-0100(-DC)	0.7 - 7.2 kgf-cm	10 - 100 in-oz
AUET-10(-DC)	1.1 - 11.5 kgf-cm	1 - 10 in-lb
AUET-50(-DC)	0.5 - 5.6 Nm	5 - 50 in-lb
AUET-100(-DC)	1.1 - 11.3 Nm	10 - 100 in-lb
AUET-250(-DC)	2.8 - 28.3 Nm	25 - 250 in-lb
AUET-500(-DC)	5.7 - 56.5 Nm	50 - 500 in-lb
AUET-1000(-DC)	11.3 - 113 Nm	100 - 1,000 in-lb
AUET-1200(-DC)	13.6 - 135.6 Nm	120 - 1,200 in-lb
AUET-1800(-DC)	20.3 - 203.4 Nm	180 - 1,800 in-lb

* Add "-DC" to part numbers for data collecting models.

Data collecting models allow multiple files/tools/applications to be associated with torque data. Requires Tool Manager software.

Custom sizes are also available. Contact an AIMCO Customer Service Associate for ordering options, 1-503-254-6600, or toll free 1-800-852-1368.

DUAL TRANSDUCER MODELS

MODEL**	RECOMMENDED TORQUE RANGE			
	TRANSDUCER 1	TRANSDUCER 2	TRANSDUCER 1	TRANSDUCER 2
AUET/MTM-050-25	0.04 - 0.4 Nm	0.3 - 2.8 Nm	5 - 50 in-oz	2.5 - 25 in-lb
AUET/MTM-050-600(-DC)	0.04 - 0.4 Nm	6.8 - 67.8 Nm	5 - 50 in-oz	60 - 600 in-lb
AUET/MTM-0100-050(-DC)	0.07 - 0.71 Nm	0.04 - 0.4 Nm	10 - 100 in-oz	5 - 50 in-oz
AUET/MTM-10-100(-DC)	0.11 - 1.12 Nm	1.3 - 11.3 Nm	1.0 - 10 in-lb	10 - 100 in-lb
AUET/MTM-50-250(-DC)	0.56 - 5.65 Nm	2.8 - 28.3 Nm	5.0 - 50 in-lb	25 - 250 in-lb
AUET/MTM-50-500(-DC)	0.56 - 5.65 Nm	5.7 - 56.5 Nm	5.0 - 50 in-lb	50 - 500 in-lb
AUET/MTM-50-1000(-DC)	0.56 - 5.65 Nm	11.3 - 113 Nm	5.0 - 50 in-lb	100 - 1,000 in-lb
AUET/MTM-100-500(-DC)	1.13 - 11.3 Nm	5.7 - 56.5 Nm	10 - 100 in-lb	50 - 500 in-lb
AUET/MTM-100-1000(-DC)	1.13 - 11.3 Nm	11.3 - 113 Nm	10 - 100 in-lb	100 - 1,000 in-lb
AUET/MTM-100-1200(-DC)	1.13 - 11.3 Nm	13.6 - 135.6 Nm	10 - 100 in-lb	120 - 1,200 in-lb
AUET/MTM-100-1600(-DC)	1.13 - 11.3 Nm	18.1 - 180.8 Nm	10 - 100 in-lb	160 - 1,600 in-lb
AUET/MTM-100-2000(-DC)	1.13 - 11.3 Nm	22.6 - 226 Nm	10 - 100 in-lb	200 - 2,000 in-lb
AUET/MTM-250-1600(-DC)	2.82 - 28.2 Nm	18.1 - 180.8 Nm	25 - 250 in-lb	160 - 1,600 in-lb
AUET/MTM-250-1800(-DC)	2.82 - 28.2 Nm	20.3 - 203.4 Nm	25 - 250 in-lb	180 - 1,800 in-lb
AUET/MTM-250-2500(-DC)	2.82 - 28.2 Nm	28.2 - 282.5 Nm	25 - 250 in-lb	250 - 2,500 in-lb
AUET/MTM-500-2500(-DC)	5.7 - 56.5 Nm	28.2 - 282.5 Nm	50 - 500 in-lb	250 - 2,500 in-lb

Custom sizes are also available. Contact an AIMCO Customer Service Associate for ordering options, 1-503-254-6600, or toll free 1-800-852-1368.

RUNDOWN FIXTURES

TORQUE MEASUREMENT: RUNDOWN FIXTURES

Features and Benefits

- Enables accurate and repeatable testing of pneumatic or electric power tools
- Mechanical Belleville system of bolt, nut or nut body, Belleville washers and main housing, 1/4" - 3/4" drive sizes, 10 in-lb - 1,200 ft-lb
- Fixtures can be ordered to simulate hard, med., or soft joints



ARDFA-XXXXHD
ARDIA-XXXXHD

ARDFA-XXXHDS
ARDIA-XXXHDS

ARDFA-XXXHDE
ARDIA-XXXHDE

ARDFA-XXX
ARDIA-XXX

Wear-Resistant Heavy Duty	X			
Heavy Duty, Fully Encapsulated		X		
Heavy Duty, Encapsulated Washers			X	
Standard (Included w/analyzer)				X
Spline Drive				
Used in Conjunction with External Transducer				
ASTIS	X	X	X	X
AISI / AISF	X	X	X	X
ARTIS	X	X	X	X

*Spline drive feature provides rundown control when testing pulse tools.

AUDITOR RUNDOWN FIXTURES

To test power tools, pneumatic or electric, consistent rotational speed must be achieved. The joint rundown fixture/simulator provides the means by which the tool motor and spindle rotates freely at the start of the test cycle and then develops torque as rotation resistance increases as fastener/joint load increases. The linearity and consistency of the joint rundown fixtures/simulators vary greatly and the tool test data is a product of the variations in these rundown fixtures. Higher quality joint rundown fixtures produce torque data with less scatter.



HDS Series

HDE Series

HD Series

ARDIA MODELS

MODEL*	RECOMMENDED TORQUE RANGE		SQUARE DRIVE
	NM	IN-LB	
ARDIA-10(HD)(HDE)(HDS)	.13 - 1.13	1.0 - 10	1/4"
ARDIA-25(HD)(HDE)(HDS)	.28 - 2.8	2.5 - 25	1/4"
ARDIA-50(HD)(HDE)(HDS)	.56 - 5.6	5 - 50	1/4"
ARDIA-100(HD)(HDE)(HDS)	1.3 - 11.3	10 - 100	1/4"
ARDIA-150(HD)(HDE)(HDS)	1.7 - 16.9	15 - 150	1/4"
ARDIA-250(HD)(HDE)(HDS)	2.8 - 28.3	25 - 250	3/8"
ARDIA-350(HD)(HDE)(HDS)	4 - 40	35 - 350	3/8"
ARDIA-500(HD)(HDE)(HDS)	5.6 - 56.5	50 - 500	3/8"
ARDIA-750(HD)(HDE)(HDS)	8.5 - 84.7	75 - 750	3/8"
ARDIA-1000(HD)(HDE)(HDS)	11.3 - 113	100 - 1,000	3/8"

*Add "HD" to part numbers for wear resistant models. Add "HDS" to part numbers for fully encapsulated wear resistant models.

*Add "HDE" to part numbers for partial encapsulated wear resistant models.

ARDFA MODELS

MODEL*	RECOMMENDED TORQUE RANGE		SQUARE DRIVE
	NM	FT-LB	
ARDFA-100(HD)(HDE)(HDS)	13.6 - 136	10 - 100	1/2"
ARDFA-150(HD)(HDE)(HDS)	20.4 - 204	15 - 150	1/2"
ARDFA-250(HD)(HDE)(HDS)	34 - 340	25 - 250	1/2"
ARDFA-500(HD)(HDE)(HDS)	67.8 - 678	50 - 500	3/4"
ARDFA-600(HD)(HDE)(HDS)	81.6 - 816	60 - 600	3/4"
ARDFA-750(HD)(HDE)(HDS)	101.7 - 1,017	75 - 750	3/4"

* Add "HD" to part numbers for wear resistant models. Add "HDS" to part numbers for fully encapsulated wear resistant models.

* Add "HDE" to part numbers for partial encapsulated wear resistant models.

GRAVITY-DEFYING BALANCERS

TW-SERIES BALANCERS



TW-0 and TW-00

- Gravity defying / "true balance"
- No tension buildup to cause worker fatigue
- Easy external direct drive tensioning
- 360° upper swivel
- Safety cable provision
- Tool clip included



TW-3 through TW-70

- Tapered drum allows "true balance" throughout cable travel
- Easy external direct drive tensioning
- Cast aluminum casing for durability
- Permanent lubrication
- 360° top swivel
- Enclosed spiral spring for added safety
- Safety chain provision (TW-3 through TW-15 models)
- Automatic safety lock plus manual drum lock (TW-22 through TW-70)

MODEL	CAPACITY		ANTI-GRAVITY CAPACITY (LB)	CABLE
	LB	KG		
TW-00	1.1 - 3.3	0.5 - 1.5	2.5 - 3.0	18" stranded steel cable 1/8" dia.
TW-0	1.1 - 3.3	0.5 - 1.5	2.5 - 3.0	3.3-ft stranded steel cable 1/8" dia.
TW-3	2.2 - 6.6	1.0 - 3.0	4.5 - 6.0	4.3-ft stranded steel cable 5/32" dia.
TW-5	5.5 - 11.0	2.5 - 5.0	8.0 - 10.5	4.3-ft stranded steel cable 5/32" dia.
TW-9	9.9 - 19.8	4.5 - 9.0	15.0 - 19.0	4.3-ft stranded steel cable 5/32" dia.
TW-15	19.8 - 33.0	9.0 - 15.0	26.0 - 32.5	4.3-ft stranded steel cable 5/32" dia.
TW-22	33.0 - 48.4	15 - 22	41.0 - 48.0	5-ft stranded steel cable 3/16" dia.
TW-30	48.4 - 66.0	22 - 30	58.0 - 65.5	5-ft stranded steel cable 3/16" dia.
TW-40	66.0 - 88.0	30 - 40	77.5 - 87.5	5-ft stranded steel cable 3/16" dia.
TW-50	88.0 - 110.0	40 - 50	100.0 - 109.5	5-ft stranded steel cable 3/16" dia.
TW-60	110.0 - 132.0	50 - 60	122.0 - 131.0	5-ft stranded steel cable 3/16" dia.
TW-70	132.0 - 154.0	60 - 70	144.0 - 153.0	5-ft stranded steel cable 3/16" dia.

ASB-SERIES BALANCERS

- Built-in Safety Features: The cable, drum, and enclosed spring are fully visible without opening the unit for easy and convenient safety checks. The sturdy spiral spring is enclosed for greater control and safety
- Ergonomic Spring Release: The automatic safety lock provides extra control
- Extended Cable Length: Stainless steel cables allow for extended reach on applications
- Enhanced Gear Mechanism: Allows for more exact adjustment of tension
- No Recoil and Low Resistance: Tapered drum style provides gravity defying tool positioning and low travel



ASB-OC Gravity Defying and Hand Adjustable Balancer



**ASB-3C
ASB-5C**

MODEL	CAPACITY		STROKE		WEIGHT	
ASB-0C	1.1 - 3.3 lb	0.5 - 1.5 kg	51.1 in	130 cm	1.5 lb	0.7 kg
ASB-3C	3.3 - 6.6 lb	1.5 - 3 kg	86.4 in	220 cm	3.0 lb	1.4 kg
ASB-5C	5.5 - 11 lb	2.5 - 5 kg	86.4 in	220 cm	3.4 lb	1.5 kg

LINE REEL BALANCERS / RETRACTORS

RETRACTORS

RPA Series

- No tools needed to set tension
- 5 ft nylon coated steel cable
- Reinforced hanging bracket includes safety cable provision
- Adjustable cable stop
- Three (3) models support weight 0.5 – 5 lb
- Tool clip included

RMA-L Series

- Steel housing with polyester finish
- Reinforced hanging bracket includes safety cable provision
- 8 ft of 3/32" diameter coated steel cable
- Permanently lubricated
- Tool clip included
- External tension adjustment
- Ratchet cable lock



RMA-L Series



RPA Series

MODEL	CAPACITY	
RPA-1	0.5 - 1.5 lb	0.2 - 0.7 kg
RPA-2	1.5 - 3.0 lb	0.7 - 1.4 kg
RPA-3	3.0 - 5.0 lb	1.4 - 2.3 kg
RMA-7L	5 - 10 lb*	2.3 - 4.8 kg*
RMA-15L	10 - 15 lb*	4.5 - 6.8 kg*
RMA-20L	15 - 23 lb*	6.8 - 10.4 kg*

* With ratchet lock



ERGO-ARM TOOL SUPPORT SYSTEMS

FEATURES AND BENEFITS

- Ergonomic support for electric and pneumatic tools reduces operator fatigue
- Increases productivity, consistency, and accuracy



AD-D1098-PAC



AD-D1098-SAC

PARALLEL ARM SERIES

AD-D1098-P, AD-D1098-PAC, AD-D1098-PACE

- Allows for freedom of movement
- Vertical adjustment eliminates cross-threading
- Fixtured tool increases repeatability
- Adjustable reach
- Available in air or oil cylinder models
- Electric tool mount standard on PACE model

SINGLE ARM SERIES

AD-D1098-S, AD-D1098-SAC

- Full tool rotation
- Allows for freedom of movement
- Adjustable reach
- Compatible with automatic screw feeder
- Available in air or oil cylinder models

MODEL	ARM STYLE	TOOL MOUNT	REACH		CAPACITY		MAXIMUM TORQUE*		
			IN	MM	LB	KG	IN-LB	NM	
AIR CYLINDER SERIES									
AD-D1098-SAC	Single	Air manifold	4 - 33	102 - 838	0 - 15	0 - 7	110	12	
AD-D1098-PAC	Parallel	Air manifold	4 - 33	102 - 838	0 - 15	0 - 7	110	12	
AD-D1098-PACE	Parallel	Electric	4 - 33	102 - 838	0 - 15	0 - 7	110	12	
OIL CYLINDER SERIES									
AD-D1098-S	Single	Air manifold**	4 - 33	102 - 838	0 - 15	0 - 7	110	12	
AD-D1098-P	Parallel	Air manifold	4 - 33	102 - 838	0 - 15	0 - 7	110	12	

* Max torque allowed may be dependent on tool clutch type and joint rate

** For single arm electric tool mount, order EAP-202ED-KIT

SPECIAL FEATURES OF CLASSIC STYLE ERGO-ARM

Dual ball bearing joint construction for smoother movement and long life

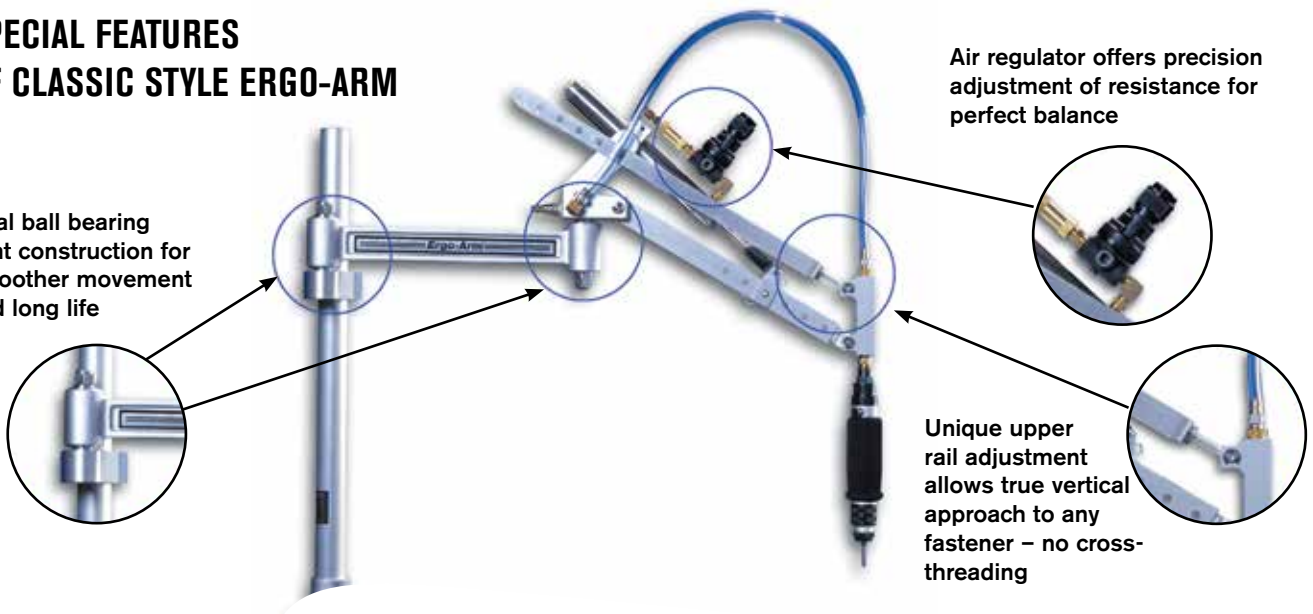

Air regulator offers precision adjustment of resistance for perfect balance

Unique upper rail adjustment allows true vertical approach to any fastener – no cross-threading

ERGO-ARM ACCESSORIES & LINEAR ARMS

ERGO-ARM ACCESSORIES

- End-of-Arm Tooling options for the Ergo-Arm allow you to choose the style right for your application
- Tool holders permit the tool to swivel, rotate, swing, or twist. Heavy duty construction can lock out any single, or combination of rotating, actions allowing only the motions required by your application
- End-of-Arm Tooling Brackets are simple to use. One Ergo-Arm can be used for more than one application

FOR USE WITH MODELS
AD-D1098-S/SAC



EAP-202ED-KIT
Electric Driver Tool
Mount Kit

FOR USE WITH MODELS
AD-D1098-P/PAC



EAP-203-ASSY
Air Manifold
Tool Mount Kit
(Standard on
parallel units)



EAP-202ASSY
Driver Tool
Mount

PARALLEL ARM KIT



EAA-04 - Provides easy conversion of standard Ergo-Arms to the parallel style.

ALA & AFA SERIES LINEAR ARMS

ERGONOMIC SUPPORT FOR ELECTRIC AND PNEUMATIC TOOLS REDUCES OPERATOR FATIGUE

The ALA Series (AIMCO Linear Arm) is constructed with precision linear slides and bearings for precise tool movements. The AFA Series (AIMCO Folding Arm) is configured with aluminum alloy beams connected by an elbow joint for working with tools in tight spaces.

ALA Series

- Constructed of lightweight aluminum
- Improves fastening quality and productivity
- Maintains perpendicularity of the tool to the application
- Absorbs torque reaction
- Counterbalances tool mass

AFA Series

- Includes all the features of the ALA Series
- Folding elbow joint allows for closer reach to post for tight workspaces

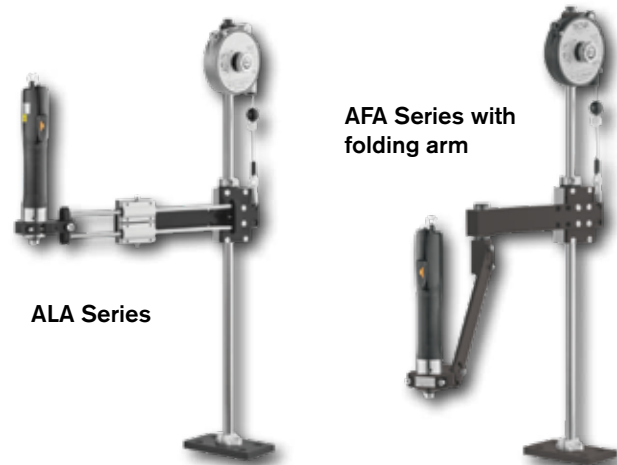

ALA Series

AFA Series with
folding arm

MODEL	MAX. TORQUE		MAX. TOOL WEIGHT		REACH		TOOL DIAMETER	
	NM	FT-LB	KG	LB	MM	IN	MM	IN
ALA SERIES LINEAR ARM								
ALA5-200	5	3.7	2	4.4	317 - 519	12.5 - 20.4	23 - 40	1.0 - 1.6
ALA15-200	15	11.1	3	6.6	317 - 519	12.5 - 20.4	23 - 40	1.0 - 1.6
ALA10-400	10	7.4	2	4.4	517 - 919	20.4 - 36.2	23 - 40	1.0 - 1.6
AFA SERIES WITH FOLDING ARM								
AFA5-400	5	3.7	2	4.4	0 - 470	0 - 18.5	23 - 40	1.0 - 1.6
AFA15-400	15	11.1	3	6.6	0 - 470	0 - 18.5	23 - 40	1.0 - 1.6
AFA10-550	10	7.4	2	4.4	0 - 620	0 - 24.2	23 - 40	1.0 - 1.6

WORKSTATION COMPONENTS AND ASSEMBLIES

COMPONENTS

TRACK

Steel with beige polyester finish. Use for vertical and horizontal workstation support.

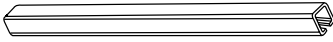

PART NUMBER	30# TRACK
AT3-3	3 ft track
AT3-4	4 ft track
AT3-6	6 ft track
AT3-9*	9 ft track

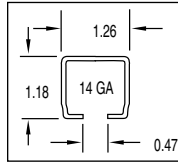

PART NUMBER	50# TRACK
AT5-3	3 ft track
AT5-4	4 ft track
AT5-6	6 ft track
AT5-9*	9 ft track
AT5-12*	12 ft track

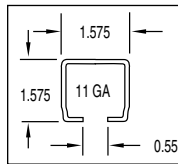

TRACK NUT (ATN-3/5)

Zinc plated steel. Use to attach accessories to track, as end stops, or to isolate rolling accessories.

- ATN-3 for 30 lb. track
- ATN-5 for 50 lb. track



END STOP (AES-3/5)

Zinc oxide finish. Use to prevent balancer trolley from "overtraveling" horizontal track.

- AES-3 for 30 lb. track
- AES-5 for 50 lb. track

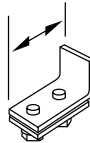

MOUNTING PLATE (AMP-5)

Black polyester finish. Use as a base to mount vertical uprights.

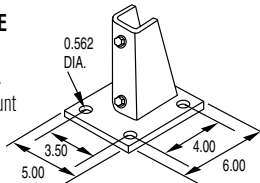

END CAP (AEP-3/5)

Black molded vinyl. Use to cap track ends for a professional finish.

- AEP-3 for 30 lb. track
- AEP-5 for 50 lb. track



ANGLE BRACKET (AB-3/5)

Black polyester finish. Use to mount horizontal track to vertical track.

- AB-3 for 30 lb. track
- AB-5 for 50 lb. track

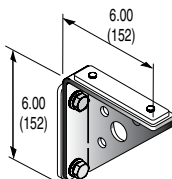

JOINT HANGER BRACKET (AJH-3/5)

Black polyester finish. Use to couple and hang end-to-end track.

- AJH-3 for 30 lb. track
- AJH-5 for 50 lb. track

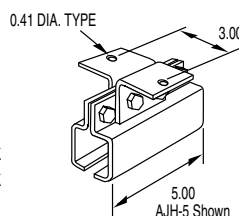

BALANCER TROLLEY (ABT-3/5)

Black polyester finish. Use as moving support for tool balancers, hose, and cable. Quality ball bearing wheels for long life and smooth tracking.

- ABT-3 for 30 lb track (1.00 dia)
- ABT-5 for 50 lb track (1.25 dia)

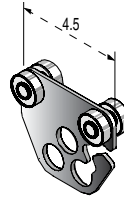

HANGER BRACKET (AHB-3/5)

Black polyester finish. Use to suspend track at right angle.

- AHB-3 for 30 lb. track
- AHB-5 for 50 lb. track

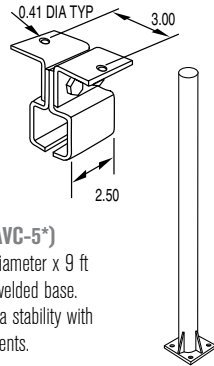

VERTICAL COLUMN (AVC-5*)

Beige polyester finish, 3" diameter x 9 ft upright steel column with welded base. Use as floor mount for extra stability with jibs or workstation components.

HOSE/CABLE TROLLEY

Black polyester finish. Use for moving cable or hose festoon. Supports hose cable OD .60-.94.

- AIC3-2 for 30 lb. track
- AIC5-2 for 50 lb. track

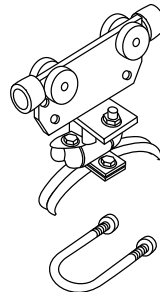

U-BOLTS (AUB-5)

Zinc plated steel. Use to secure boom bracket, or any flat metal plate, to AVC-5 (sold individually).



END CLAMP (AEC5-2)

Black polyester finish. Use as end stop with hose carrier for festoon. Cable/hose OD .60-.94.

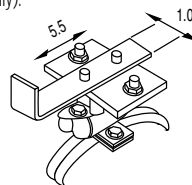

SUPPORT CLAMPS (ASC-3/5)

Black polyester finish. Use as additional support for track.

- ASC-3 for 30 lb. track
- ASC-5 for 50 lb. track

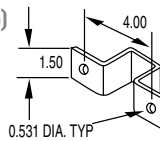

TOOL CLIP (SH-5)

Steel clip with safety latch. Use for tool attachment and as replacement clip for lightweight tool balancers. Measures 2.37" long.



ROLLING HANGER (ABT5-R)

Black polyester finish. Use as support for rolling track. Allows X/Y axis movement, includes ball bearing wheels.

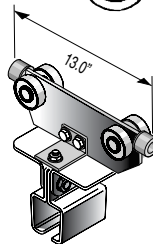

90° CONNECTOR FOR 3/8" HOSE (WSCH)

3/8" I.D. Brass. Use to provide stable transfer point from air line to tool. 90 degree connector attaches to ABT-5.

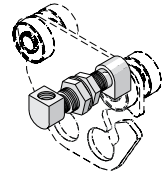

WALL- AND FLOOR-MOUNTED JIBS

3 FT. SWINGING JIB (AW3S)

3 FT. FIXED JIB (AW3F)

3 FT. SWINGING JIB FOR CHANNEL MOUNT (AJS3**)

Jibs are mounted to wall or beams to create free standing workstations. End stop, end cap, and balancer trolley included. Maximum weight: 30 lb.

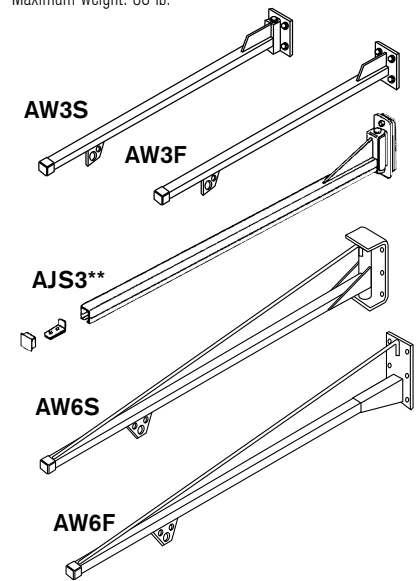

6 FT. SWINGING JIB (AW6S)

6 FT. FIXED JIB (AW6F)

Jibs can be wall mounted or attached to vertical column (AVC-5) to create a freestanding workstation. End stop, end caps, and balancer trolley are included. Maximum weight: 50 lb.

All complete assemblies are beige polyester finish and include balancer trolley, end caps, and end stops. Floor mounted assemblies are not able to ship via UPS.

When choosing a workstation system, remember...

Total weight capacities should include tool balancer, hose/cable, and tool/fixture. Units need to be supported vertically and horizontally every 6 ft.

- * Additional freight may apply
- ** AJS3 Does not include balancer trolley

WORKSTATION COMPONENTS AND ASSEMBLIES

**FLOOR MOUNTED
3 FT. SWINGING JIB***
(AW3FMS)

**FLOOR MOUNTED
3 FT. FIXED JIB***
(AW3FMF)
Maximum weight: 30 lb
Column height: 6 ft

**FLOOR MOUNTED
6 FT. SWINGING JIB***
(AW6FMS*)

**FLOOR MOUNTED
6 FT. FIXED JIB***
(AW6FMF*)
Maximum weight: 50 lb
Column height: 9 ft

*Units include end stop,
balancer trolley and intermediate carrier.

BENCH MOUNTED SWINGING JIB (JJ30-S)
BENCH MOUNTED FIXED JIB (JJ30)
Maximum weight: 30 lb
Column height: 48" including mounting plate
3 ft. swinging jib includes balancer
trolley, end stop, and cap

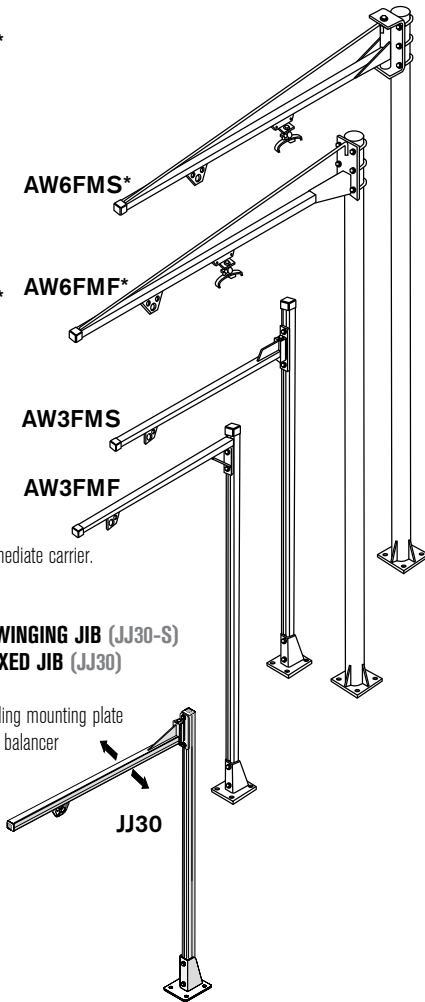

AIMCO WORKSTATION KIT

**BENCH MOUNTED WORKSTATION
WITH TORQUE ARM (JJ30-TA**)**

- 5 lb. maximum weight (RPA-3 included)
- 5' column height including mounting plate
- 38" jib length (swinging)
- 15 ft-lb torque rating
- 3/8" NPT inlet
- 1/4" NPT outlet
- Beige polyester finish
- 1/4" braided air hose
- 21" maximum vertical arm travel

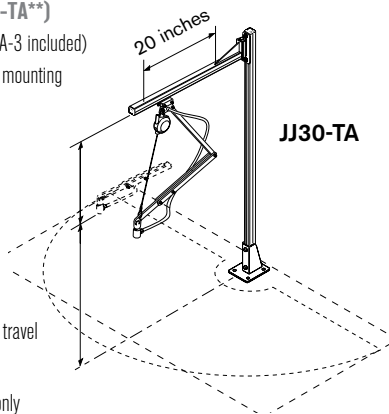

**Additional freight may apply
**For use with pneumatic tools only

CREATE A CUSTOM SUPPORT SYSTEM USING AIMCO'S QUALITY PRODUCTS

- Organize work area to create a safe, productive working environment
- Reduce risk of injury to assembler by providing support for heavy tools
- Protect valuable tools, fixtures, and monitoring devices from damage by suspending them out of the way

AIMCO BASIC WORKSTATION KIT (ATW-50)



- 50 lb maximum weight capacity
- 48" uprights
- 36" extensions
- Table mounts included
- 6' tool rail with rolling trolley included
- All necessary hardware included

TROLLEY MOUNTED TORQUE ARM WITH 3-LB RETRACTOR AND HOSE (FA-50-2*)

Ergonomic arm absorbs torque reaction.
Moves front to back along overhead jib.

(TA-50-2)

Moves side to side on overhead track.

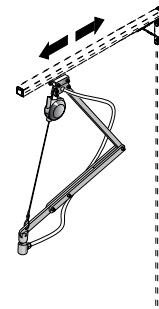

TOOL BASKET (21226)

Mounts easily to any work area to hold
pistol and angle style tools.

AIMCO can customize a workstation for you.

Contact an AIMCO Customer Service Associate 1-503-254-6600, or toll free 1-800-852-1368.



AIR PREPARATION UNITS

AFRL STACKING FILTER/REGULATORS

Stacking filter/regulator combinations provide air filtration and precise regulation in a single unit for easy mounting and installation.

FEATURES AND BENEFITS

- All models include L-mount bracket, gauge, and metal bowl shields
- Polycarbonate filter and lubricator bowls (metal bowls standard on AFRL-8)
- 25-micron filter included on all models
- Regulating range: 7 – 125 PSI
- Custom order upgrade items include metal bowl, 5 micron filter, semi-automatic filter drain, and reduced PSI range regulator. Contact an AIMCO Customer Service Associate for more information, 1-503-254-6600, or toll free 1-800-852-1368

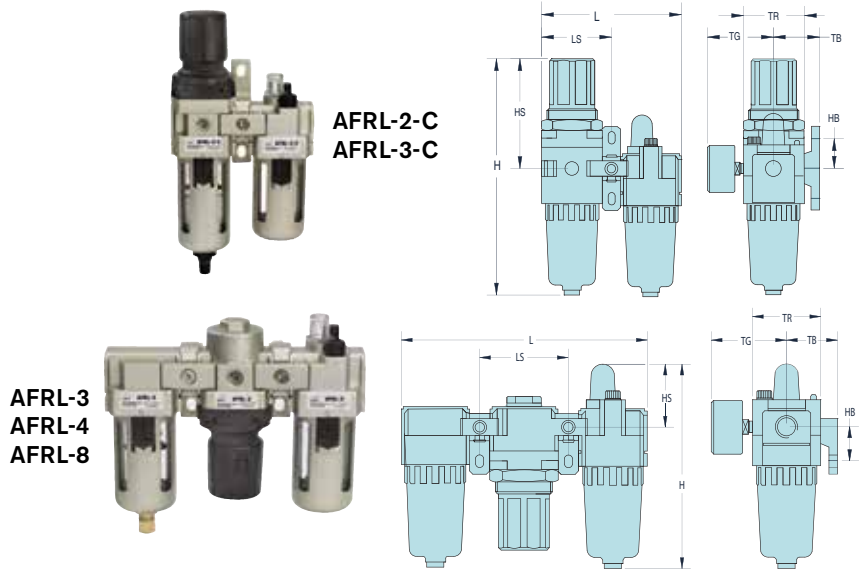

MODEL	PORT	GAUGE		FLOW RATE		BOWL SHIELD	H IN/MM	HB IN/MM	HS IN/MM	L IN/MM	LS IN/MM	TB IN/MM	TG IN/MM	TR IN/MM
		PORT	PORT	CFM	L/MIN									
AFRL-2	1/4"	1/8"	70	2,000	yes	6.16 (156.5)	1.39 (35.3)	1.50 (38.1)	7.13 (181.1)	2.52 (64.0)	1.61 (41.0)	2.39 (60.7)	2.09 (53.1)	
AFRL-2-C	1/4"	1/8"	60	1,700	yes	8.31 (211.1)	1.38 (35.1)	3.64 (92.5)	4.61 (117.1)	2.30 (58.4)	1.61 (40.9)	2.39 (60.7)	2.09 (53.1)	
AFRL-3	3/8"	1/4"	140	4,000	yes	7.54 (191.5)	1.57 (40.0)	1.61 (40.9)	9.37 (238.0)	3.31 (84.1)	1.97 (50.0)	2.58 (65.5)	2.76 (70.1)	
AFRL-3-C	3/8"	1/4"	105	3,000	yes	10.31 (261.9)	1.57 (39.9)	4.41 (112.0)	6.06 (153.9)	3.03 (77.0)	1.97 (50.0)	2.58 (65.5)	2.76 (70.1)	
AFRL-4	1/2"	1/4"	140	4,000	yes	7.54 (191.5)	1.57 (40.0)	1.61 (40.9)	9.37 (238.0)	3.31 (84.1)	1.97 (50.0)	2.58 (65.5)	2.76 (70.1)	
AFRL-8	1"	1/4"	180	5,000	yes	10.69 (271.5)	1.97 (50.0)	1.89 (48.0)	11.81 (300.0)	4.13 (104.9)	2.75 (69.9)	2.97 (75.4)	3.54 (89.9)	



AIR LINE

Polyurethane Hose



- Durable Polyurethane is chemical resistant and lightweight, and provides excellent recoil memory and maximum flexibility
- Available in transparent hose color (opaque also available)
- Assemblies for coiled hose include reusable swivel fitting. Straight hose available with or without fittings
- Working temperature: -104° F to 175° F

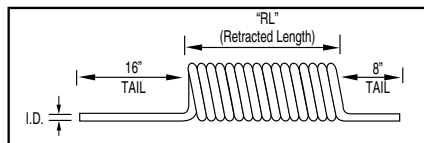

SINGLE AIR HOSE ASSEMBLIES (COILED)

MODEL	DESCRIPTION (O.D. x I.D. x LENGTH)	RETRACTED LENGTH	WORKING PRESSURE	NPT FITTINGS
ASH-250C-10MSZ	3/8" x 1/4" x 10'	7"	100 psi	1/4"
ASH-250C-15MSZ	3/8" x 1/4" x 15'	9-1/2"	100 psi	1/4"
ASH-250C-25MSZ	3/8" x 1/4" x 25'	15-1/2"	100 psi	1/4"
ASH-375C-15MSZ	9/16" x 3/8" x 15'	10"	100 psi	3/8"
ASH-375C-25MSZ	9/16" x 3/8" x 25'	14"	100 psi	3/8"
ASH-500C-15MSZ	3/4" x 1/2" x 15'	13"	100 psi	1/2"
ASH-500C-25MSZ	3/4" x 1/2" x 25'	23"	100 psi	1/2"

Custom length coil assemblies and special colors available in minimum order quantities. Contact an AIMCO Customer Service Associate, 1-503-254-6600, or toll free 1-800-852-1368.



STRAIGHT AIR HOSE (SOLD PER FOOT)

MODEL	DESCRIPTION
ASH-375Z	3/8" I.D.
ASH-500Z	1/2" I.D.

Contact an AIMCO Customer Service Associate about full reel pricing, 1-503-254-6600, or toll free 1-800-852-1368.

Rubber Hose



- Designed for use in a wide range of industrial, construction, and agricultural applications
- Constructed of high grade, reinforced EPDM synthetic rubber
- Working temperature: -40° F to 190° F

SINGLE AIR HOSE (RUBBER)

I.D.	O.D.	LENGTH	WORKING PRESSURE	WEIGHT
3/16"	0.44"	10 ft	200 psi	0.8 lb
1/4"	0.5"	10 ft	200 psi	0.9 lb
5/16"	0.58"	10 ft	200 psi	1.2 lb
3/8"	0.67"	10 ft	200 psi	1.5 lb
1/2"	0.81"	10 ft	200 psi	2.0 lb
5/8"	0.97"	10 ft	200 psi	2.7 lb
3/4"	1.12"	10 ft	200 psi	3.4 lb

Custom lengths available. Contact an AIMCO Customer Service Associate for more details, 1-503-254-6600, or toll free 1-800-852-1368.

HELPFUL HINTS FOR AIR HOSE USE

- Use recommended I.D. air hose and fittings
- Replace air hose regularly to help maintain clean air
- A clear hose allows you to see water or dirt accumulation in hose
- Use correct length of hose to reduce air loss and pressure drop
- Use locking quick-disconnect couplers for additional safety

AIR LINE ACCESSORIES

BRASS QUICK COUPLERS

Manual ball couplers designed for use with ergonomic twist plugs. Brass with nitrile seals, rated to 300 PSI, from -40° to +250° F.

MODEL	DESCRIPTION
B23	1/4" NPT F x 1/4" QC Brass Coupler
B23E	1/4" NPT F x 3/8" QC Brass Coupler
B25	3/8" NPT F x 3/8" QC Brass Coupler



SWIVEL AIR FITTINGS

For use with most portable air tools, including grinders, drills, screwdrivers, buffers, sanders, staple guns, and more. Rotates 360° for awkward angles.

MODEL	INLET	WEIGHT	MAX PSI	TOOL CFM
7021	1/4" NPT	3 oz	Up to 125	25
7041A	3/8" NPT	11 oz	Up to 125	50
7051	1/2" NPT	7 oz	Up to 125	60

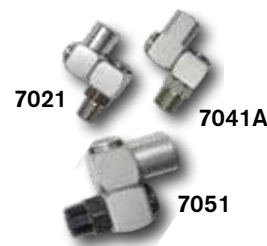

MINI AIR GAUGE SWIVEL JOINT KITS

- Bi-directional 360° rotation
- Keeps air hose straight and untwisted
- Decreases operator fatigue



MODEL	INLET	WEIGHT	MAX PSI	TOOL CFM
7021AG	1/4" NPT	3 oz	Up to 125	25
7041AG	3/8" NPT	3 oz	Up to 125	50



AIR LINE FITTINGS

MODEL	CAPACITY
250-RZ	1/4" NPT Rigid Fitting
250-SZ	1/4" NPT Swivel Fitting
375-RZ	3/8" NPT Rigid Fitting
375-SZ	3/8" NPT Swivel Fitting
500-SZ	1/2" NPT Swivel Fitting



ERGONOMIC TWIST PLUGS

These unique, ergonomically designed hose fittings provide 360° rotation and 35° angled rotation in any direction.

- Two rotation points prevent kinking of air hose
- Design ensures full air pressure flow
- Rotating joint comes with polyurethane dust cover
- Heavy duty construction

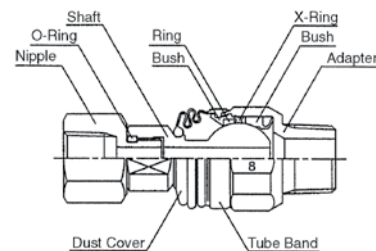
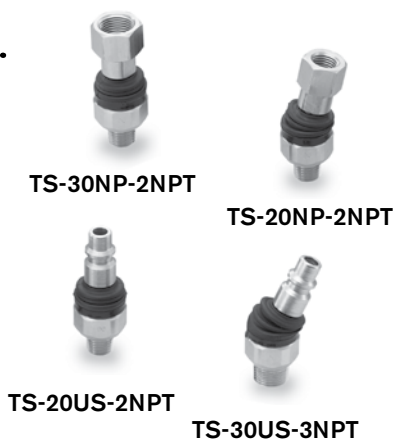





MODEL	DESCRIPTION
TS-30NP-2NPT	3/8" NPT Female x 1/4" NPT Male
TS-20NP-2NPT	1/4" NPT Female x 1/4" NPT Male
TS-20US-2NPT	1/4" US Plug x 1/4" NPT Male
TS-30US-3NPT	3/8" US Plug x 3/8" NPT Male

CONVERSION CHARTS

Fraction ■ Decimal ■ Metric Conversions (to .32)

	DECIMAL	MM		DECIMAL	MM		DECIMAL	MM		DECIMAL	MM
1/32	.03125	.7938	9/32	.28125	7.1438	17/32	.53125	13.4938	25/32	.78125	19.8438
1/16	.0625	1.5875	5/16	.3125	7.9375	9/16	.5625	14.2875	13/16	.8125	20.6375
3/32	.09375	2.3812	11/32	.34375	8.7312	19/32	.59375	15.0812	27/32	.84375	21.4312
1/8	.125	3.175	3/8	.375	9.525	5/8	.625	15.875	7/8	.875	22.225
5/32	.15625	3.9688	13/32	.40625	10.3188	21/32	.65625	16.6688	29/32	.90625	23.0188
3/16	.1875	4.7625	7/16	.4375	11.1125	11/16	.6875	17.4625	15/16	.9375	23.8125
7/32	.21875	5.5562	15/32	.46875	11.9062	23/32	.71875	18.2562	31/32	.96875	24.6062
1/4	.25	6.35	1/2	.5	12.7	3/4	.75	19.05	1	1.0	25.4

Thread Size to Hex Size

							
METRIC BOLT SIZE	SOCKET HEX SIZE (MM)	METRIC BOLT SIZE	SOCKET HEX SIZE (MM)	UNC BOLT SIZE	SOCKET HEX SIZE (IN)	SAE BOLT SIZE	SOCKET HEX SIZE (IN)
M 2	4	M 27	41	1/4	7/16	1/4	7/16
M 2.3	4.5	M 30	46	5/16	1/2	5/16	1/2
M 2.6	5	M 33	50	3/8	9/16	3/8	9/16
M 3	5.5	M 36	55	7/16	11/16	7/16	5/8
M 3.5	6	M 39	60	1/2	3/4	1/2	3/4
M 4	7	M 42	65	9/16	7/8	9/16	7/8
M 5	8	M 45	70	5/8	15/16	5/8	15/16
(M 5-6)	9	M 48	75	3/4	1-1/8	3/4	1-1/16
M 6	10	M 52	80	7/8	1-5/16	7/8	1-1/4
M 7	11	M 56	85	1	1-1/2	1-1/8	1-7/16
M 8	13	M 60	90	1-1/8	1-11/16	1-1/4	1-13/16
(M 8)	14	M 64	95	1-1/4	1-7/8	1-3/8	2
M 10	16	M 68	100	1-3/8	2-1/16	1-1/2	2-3/16
(M 10)	17	M 72	105	1-1/2	2-1/4		
M 12	18	M 76	110	1-3/4	2-5/8		
(M 12)	19	M 80	115	2	3		
M 14	21	M 85	120	2-1/4	3-3/8		
(M 14)	22	M 90	130	2-1/2	3-3/4		
M 16	24	M 95	135				
M 18	27	M 100	145				
M 20	30	M 105	150				
(M 22)	32	M 110	155				
M 22	34	M 115	165				
M 24	36	M 120	170				

Torque Conversion Factors

UNITS TO BE CONVERTED	=	SAE				METRIC		INTERNATIONAL SYSTEM - S.I.		
		OZF-IN	LBF-IN	LBF-FT	GF-CM	KGF-CM	KGF-M	MNM	CNM	NM
1 ozf-in	=	1	0.0625	0.005	72	0.072	0.0007	7.062	0.706	0.007
1 lbf-in	=	16	1	0.083	1152.1	1.152	0.0115	113	11.3	0.113
1 lbf-ft	=	192	12	1	13826	13.83	0.138	1356	135.6	1.356
1 gf-cm	=	0.014	0.0009	0.00007	1	0.001	0.00001	0.098	0.01	0.0001
1 kgf-cm	=	13.89	0.868	0.072	1000	1	0.01	98.07	9.807	0.098
1 kgf-m	=	1389	86.8	7.233	100000	100	1	9807	980.7	9.807
1 mN-m	=	0.142	0.009	0.0007	10.2	0.01	0.0001	1	0.1	0.001
1 cN-m	=	1.42	0.088	0.007	102	0.102	0.001	10	1	0.01
1 N-m	=	141.6	8.851	0.738	10197	10.20	0.102	1000	100	1



CORPORATE HEADQUARTERS

10000 SE Pine Street
Portland, Oregon 97216
Phone: (503) 254-6600
Toll Free: 1-800-852-1368

AIMCO CORPORATION DE MEXICO SA DE CV

Ave. Cristobal Colon 14529
Chihuahua, Chihuahua. 31125
Mexico
Phone: (01-614) 380-1010
Fax: (01-614) 380-1019

LIT-AT402, Rev. 06/19/19
Printed in USA ©2019 AIMCO