

AIMCO

FASTENER TOOLS

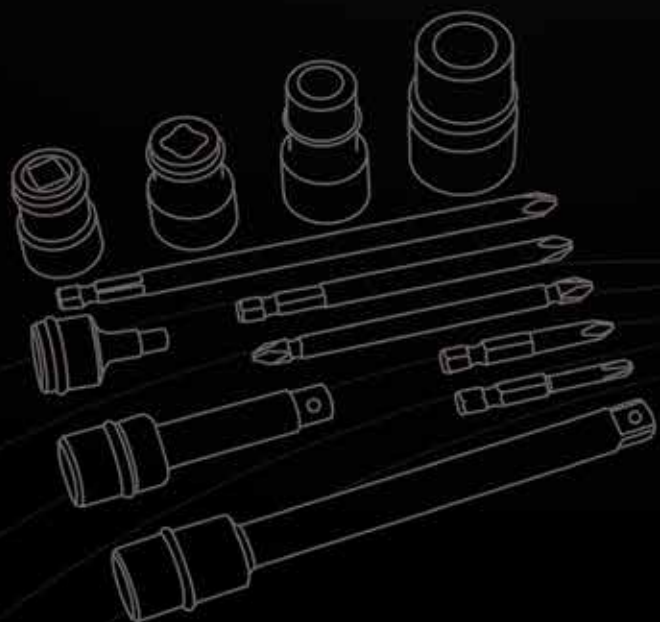

STANDARD FASTENER TOOLS

STANDARD FASTENER TOOLS

Connect your tool to the application with Bits, Sockets and Nutsetters from AIMCO.

AIMCO has assembled the most complete package of commonly used screwdriver bits and nutsetters in the industry. Our goal is to supply you with the highest quality bits and nutsetters for your fastener needs. Whether you're in electronics, aerospace, automotive, or general industry, AIMCO has the bits and nutsetters to fit your needs.

IMPACT SOCKETS

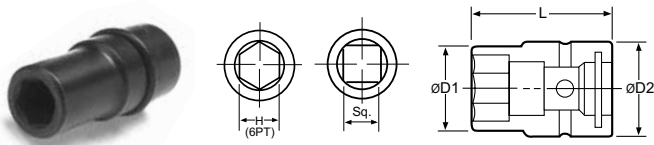

PART NO	HEX	D1 MM	D1 IN	D2 MM	D2 IN	L MM	L IN
---------	-----	----------	----------	----------	----------	---------	---------

3/8" Square Drive								
SAE	A31/4	1/4"	10	0.39	19	0.75	34	1.34
	A35/16	5/16"	12	0.47	19	0.75	34	1.34
	A33/8	3/8"	15	0.59	19	0.75	34	1.34
METRIC	A306	6 mm	10	0.39	19	0.75	34	1.34
	A307	7 mm	13	0.49	20	0.79	32	1.26
	A308	8 mm	14	0.55	20	0.79	32	1.26

3/8" Square Drive, Deep								
	A307-2	7 mm	13	0.49	20	0.79	50	1.97
	A307-2.75	7 mm	13	0.49	20	0.79	70	2.76
	A308-2	8 mm	14	0.55	20	0.79	50	1.97

3/8" Square Drive, Magnetic								
SAE	A31/4MP	1/4"	10	0.39	19	0.75	34	1.34
	A35/16MP	5/16"	12	0.47	19	0.75	34	1.34
	A33/8MP	3/8"	15	0.59	19	0.75	34	1.34
METRIC	A308MP	8 mm	14	0.55	20	0.79	32	1.26
	A310MP	10 mm	17	0.65	20	0.79	32	1.26
	A311MP	11 mm	17	0.65	19	0.75	34	1.34

1/2" Square Drive								
SAE	A43/8	3/8"	16	0.63	25	0.98	38	1.50
	A47/16	7/16"	18	0.69	25	0.98	38	1.50
	A41/2	1/2"	19	0.75	25	0.98	50	1.97
METRIC	A408	8 mm	16	0.61	25	0.98	40	1.58
	A409	9 mm	16	0.63	25	0.98	40	1.58
	A410	10 mm	18	0.69	25	0.98	40	1.58

1/2" Square Drive, Deep								
SAE	A43/8-3.25	3/8"	17	0.67	25	0.98	82	3.23
	A47/16-3.25	7/16"	19	0.73	25	0.98	82	3.23
	A41/2-3.25	1/2"	22	0.85	25	0.98	82	3.23
METRIC	A410-2	10 mm	18	0.69	25	0.98	50	1.97
	A410-3	10 mm	18	0.69	25	0.98	75	2.95
	A410-3.25	10 mm	17	0.67	25	0.98	82	3.23
	A411-3.25	11 mm	19	0.73	25	0.98	82	3.23

Additional types and sizes of fastener tools, as well as custom parts, are available upon request. 1-800-852-1368.

PART NO	HEX	D1 MM	D1 IN	D2 MM	D2 IN	L MM	L IN
---------	-----	----------	----------	----------	----------	---------	---------

1/2" Square Drive, Magnetic								
	A408MP	8 mm	16	0.61	25	0.98	40	1.58
	A410MP	10 mm	18	0.69	25	0.98	40	1.58
	A412MP	12 mm	21	0.81	25	0.98	40	1.58

3/4" Square Drive								
SAE	A611/16	11/16"	30	1.18	44	1.73	50	1.97
	A63/4	3/4"	32	1.26	44	1.73	50	1.97
	A613/16	13/16"	35	1.38	44	1.73	50	1.97
METRIC	A614	14 mm	24	0.95	38	1.50	55	2.17
	A616	16 mm	27	1.06	44	1.73	50	1.97
	A617	17 mm	30	1.18	38	1.50	55	2.17

3/4" Square Drive, Deep								
SAE	A611/16-4	11/16"	31	1.22	44	1.73	100	3.94
	A63/4-4	3/4"	33	1.30	44	1.73	100	3.94
	A613/16-4	13/16"	36	1.42	44	1.73	100	3.94
METRIC	A617-4	17 mm	31	1.22	44	1.73	100	3.94
	A618-4	18 mm	32	1.26	44	1.73	100	3.94
	A619-4	19 mm	33	1.30	38	1.50	100	3.94

1" Square Drive								
SAE	A87/8	7/8"	37	1.46	54	2.13	59	2.32
	A815/16	15/16"	38	1.50	54	2.13	59	2.32
	A81	1"	41	1.61	54	2.13	59	2.32
METRIC	A817	17 mm	31	1.22	50	1.97	63	2.48
	A819	19 mm	33	1.30	50	1.97	63	2.48
	A821	21 mm	37	1.46	50	1.97	63	2.48

QUICK CHANGE CHUCKS

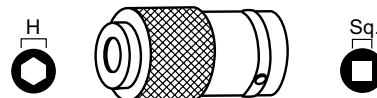

PART NO	SQ DRIVE	HEX	D1 MM	D1 IN	L MM	L IN
ADC-2S	1/4"	1/4"	19	0.75	38	1.50
ADC-3S	3/8"	1/4"	20	0.79	42	1.65
ADC-4S	1/2"	1/4"	19	0.75	46	1.81
ADC-3SH7/16Z	3/8"	7/16"	25	0.98	46	1.81
ADC-4SH7/16Z	1/2"	7/16"	33	1.30	55	2.17

ALLEN SOCKETS

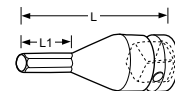

PART NO	HEX	L1 MM	L1 IN	L MM	L IN
---------	-----	----------	----------	---------	---------

3/8" Square Drive					
A31/4C	1/4"	10	0.39	42	1.65
A304C	4 mm	10	0.39	42	1.65

1/2" Square Drive					
A41/4C	1/4"	25	0.98	50	1.97
A405C	5 mm	25	0.98	50	1.97

STANDARD FASTENER TOOLS

UNIVERSAL SOCKETS

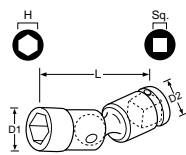

PART NO	HEX	D1 MM	D1 IN	D2 MM	D2 IN	L MM	L IN
3/8" Square Drive							
A310U	10 mm	16	0.63	20	0.79	55	2.17
A311U	11 mm	16	0.63	20	0.79	60	2.36
1/2" Square Drive							
A412U	12 mm	20.5	0.81	25	0.98	70	2.76
A413U	13 mm	19	0.75	24	0.95	70	2.76

NUTSETTERS

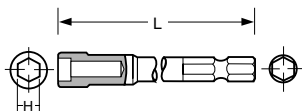

PART NO	HEX	L MM	L IN
A3B1/4-2	1/4"	50	1.97
A3B1/4-2.5	1/4"	63	2.50
A3B5/16-2	5/16"	50	1.97
A3B5/16-2.5	5/16"	63	2.50
A3B3/8-2	3/8"	50	1.97
A3B3/8-2.5	3/8"	63	2.50
A3B05-2.75	5 mm	70	2.76
A3B55-1.2	5.5 mm	30	1.18
A3B55-2.75	5.5 mm	70	2.76
A3B55-4	5.5 mm	100	3.94
A3B06-2.75	6 mm	70	2.76
A3B07-1.2	7 mm	30	1.18
A3B07-2	7 mm	50	1.97
A3B07-2.75	7 mm	70	2.76
A3B07-4	7 mm	100	3.94
A3B08-1.2	8 mm	30	1.18
A3B08-2	8 mm	50	1.97
A3B08-2.75	8 mm	70	2.76
A3B08-4	8 mm	100	3.94
A3B08-6	8 mm	150	5.91
A3B08-8	8 mm	200	7.87
A3B09-2.75	9 mm	70	2.76
A3B09-4	9 mm	100	3.94
A3B10-1.2	10 mm	30	1.18
A3B10-2	10 mm	50	1.97
A3B10-2.75	10 mm	70	2.76
A3B11-2.75	11 mm	70	2.76
A3B12-1.2	12 mm	30	1.18
A3B13-2.75	13 mm	70	2.76
A3B14-2.75	14 mm	70	2.76
A3B16-2.75	16 mm	70	2.76
A3B17-2.75	17 mm	70	2.76

EXTENSIONS

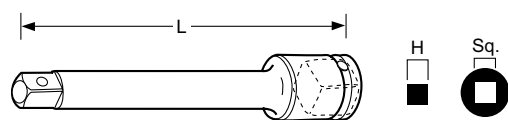

PART NO	SQ DRIVE	HEX	L MM	L IN	D MM	D IN
A375E	3/8"	3/8"	75	2.95	20	0.79
A405E	1/2"	1/2"	51	2.01	30	1.18
A610E	3/4"	3/4"	100	3.94	44	1.73
A810E	1"	1"	102	4.02	54	2.13
A1220E	1-1/4"	1-1/4"	200	7.87	60	2.36
A1418E	1-1/2"	1-1/2"	178	7.01	84	3.31
A2426E	2-1/2"	2-1/2"	264	10.39	137	5.39

SOCKET ADAPTERS

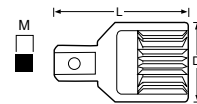

PART NO	FEMALE SQ. DRIVE	MALE SQ. DRIVE	D MM	D IN	L MM	L IN
A302A	3/8"	1/4"	22	0.87	35	1.38
A403A	1/2"	3/8"	25	0.98	37	1.46
A504A	5/8"	1/2"	35	1.38	47	1.46
A604A	3/4"	1/2"	38	1.50	53	2.09
A806A	1"	3/4"	50	1.97	70	2.76
A128A	1-1/4"	1"	60	2.36	76	2.99
A#508A	Spline #5	1"	60	2.36	90	3.54

Bit and Nutsetter Part Number Nomenclature

Precedes Part Number		Contained within Part Number
BITS	A7 = 7/16 Power Drive	BITS
A3S = Phillips® Power Drive	AS = Electric Type Phillips®	PZ = Pozidriv®
A3W = Double Ended Phillips®	AM = Electric Type Slotted Phillips®	PZACR = Pozidriv® ACR®
A38S = Phillips® Insert	ATW = Electric Type Tri-Wing®	SDV = Supadriv®
A39S = Phillips® Insert Reduced Nose	AT = Electric Hios Type Torx®	TR = Torx® Tamper Resistant
A3M = Slotted Power Drive	A26S = Electric Driver Socket Head Phillips®	ACRI = ACR® Installation
A38M = Slotted Insert	A26M = Electric Driver Slotted Phillips®	ACR = ACR® Remove
A3MT = Slotted Power Drive Reduced Nose	A26C = Electric Driver Allen Socket Head	ACRB = ACR® 4x4 Both Install and Remove
A3C = Allen Socket Head Power Drive	A3BHM = Insert Bit Holder (Magnetic Type)	E4 = Electric 4mm diameter
A38C = Allen Socket Head Insert	A3BHD = Insert Bit Holder (Non Magnetic)	E5 = Electric 5mm diameter
A3R = Square Recess Power Drive		RS = Reduced Shank
A3RT = Square Recess Turned Down (Power)	NUTSETTERS	
A38R = Square Recess Insert	A3B = Nutsetter	
A3T = Torx® Power Drive	A3BMP = Magnetic (MP) Pressed Type	
A38T = Torx® Insert	A3BMS = Magnetic (MS) Spring Loaded	
A3TS = Torq-Set® Power Drive	A3BMT = Magnetic (MT) Tube Type	
A38TS = Torq-Set® Insert	A3BU = Universal Nutsetter	
A3TA = Triangle Power Drive		
A3TW = Tri-Wing® Power Drive	MAG-O-NETS	
A38TW = Tri-Wing® Insert	AM = AIMCO Mag-O-Net®	

Additional types and sizes of fastener tools, as well as custom parts, are available upon request. 1-800-852-1368.

STANDARD FASTENER TOOLS

MAG-O-NETS®: A Revolutionary Way to Convert Standard Bits to Magnetic Bits

FEATURES AND BENEFITS

- Easy, cost effective alternative to traditional magnetic bit holder and insert bit combination.
- Improves torque transfer by eliminating “wobble effect.”
- Easily adjust magnetic attraction by moving Mag-O-Net collar closer to or further from fastener.
- Fits virtually any standard screwdriver bit.
- Reusable and interchangeable – once a bit is worn out, simply remove your Mag-O-Net and slide it onto the next bit.
- Lifetime guarantee on magnetic attraction.



*U.S. Patent 5861789

PART NO	INNER DIAMETER (ID)	OUTER DIAMETER (OD)	L MM
AM1/4Z	7 mm	19 mm	10
AM5Z	6 mm	17.5 mm	10
AM3/16Z	3/16 in	17.5 mm	10

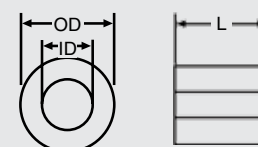

PHILLIPS POWER BITS

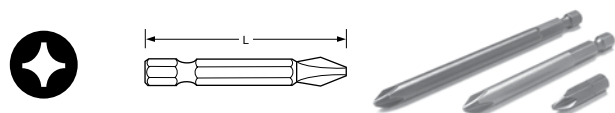

PART NO	POINT SIZE	L MM	L IN
A3S0-2	0	50	1.97
A3S1-2	1	50	1.97
A3S1-2.75	1	70	2.76
A3S1-3	1	75	2.95
A3S1-3.5	1	90	3.54
A3S1-4	1	100	3.94
A3S1-6	1	150	5.91
A3S2-1.2	2	30	1.18
A3S2-1.6	2	40	1.57
A3S3-2	3	50	1.97
A3S3-2.75	3	70	2.76

Double-Ended

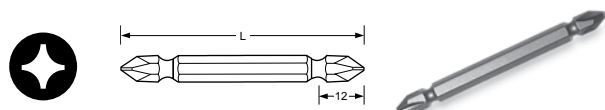

A3W1-3	1	75	2.94
A3W1-4	1	100	3.94
A3W2-2	2	50	1.97
A3W2-3	2	75	2.94
A3W2-4	2	100	3.94
A3W2-6	2	150	5.91
A3W2-8	2	200	7.87
A3W2-10	2	250	9.84
A3W2-12	2	300	11.81
A3W3-2	3	50	1.97
A3W3-3	3	75	2.94
A3W3-4	3	100	3.94
A3W3-6	3	150	5.91
A3W3-8	3	200	7.87

TORX POWER BITS

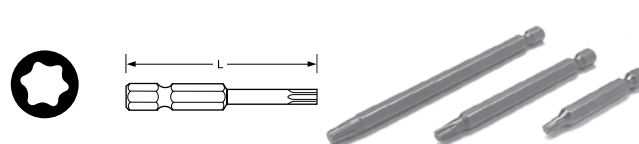

PART NO	TORX SIZE	L MM	L IN
A3T6-2	T6	50	1.97
A3T7-2	T7	50	1.97
A3T7-2.75	T7	70	2.76
A3T7-3.5	T7	90	3.54
A3T7-6	T7	150	5.91
A3T8-2	T8	50	1.97
A3T9-2.75	T9	70	2.76

BIT HOLDERS



PART NO	L MM	L IN
1/4" Hex, Magnetic		
A3BHM-3	75	2.94
A3BHM-4	100	3.94
A3BHM-6	150	5.91
A3BHM-8	200	7.87
A3BHM-10	250	9.84

Additional types and sizes of fastener tools, as well as custom parts, are available upon request. 1-800-852-1368.

ERGO-DRIVE® SERIES

ERGO-DRIVE® SOCKETS PROTECT...



...YOUR INVESTMENT!

Pulse tools are an investment and the anvil is the most expensive single part of any pulse tool. ERGO-DRIVE® sockets decrease vibration and wear on this critical component.

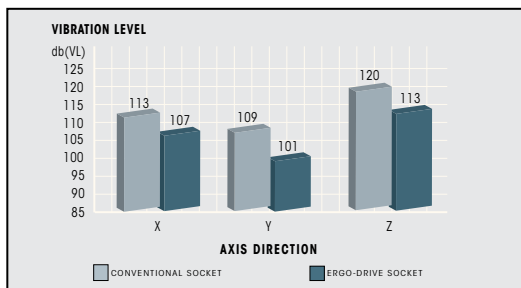
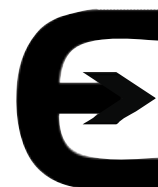

...YOUR ASSEMBLERS!

ERGO-DRIVE® sockets cause significantly less vibration during fastening than conventional sockets. This allows your assemblers to do their jobs without the worry of vibration related injuries.

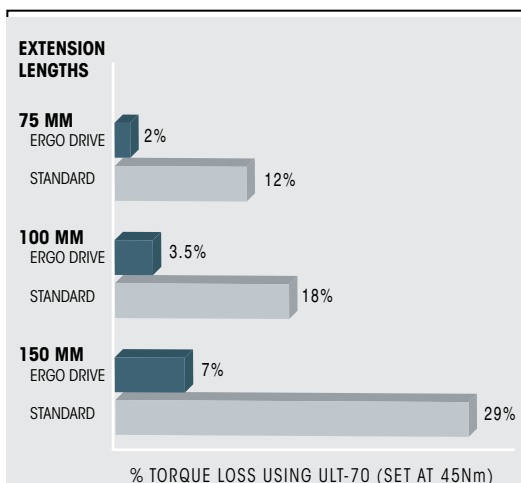

...YOUR PRODUCTS!

By reducing run-out and vibration, ERGO-DRIVE® sockets allow the most repeatable, accurate rundowns to take place, ensuring excellent product quality.

ERGO-DRIVE® VS. STANDARD

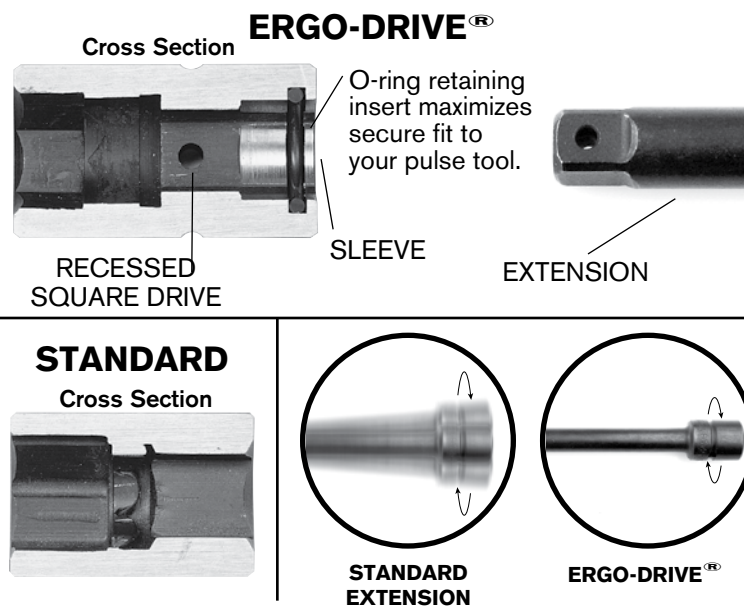

ERGO-DRIVE® FASTENER TOOLS

ERGO-DRIVE® SOCKETS

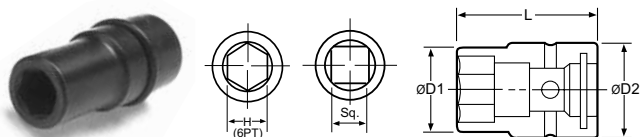

PART NO	HEX	D1 MM	D1 IN	D2 MM	D2 IN	L MM	L IN
---------	-----	----------	----------	----------	----------	---------	---------

3/8" Square Drive							
A314EDS	1/4"	10	0.39	19	0.75	44	1.73
A312EDS	1/2"	20	0.77	22	0.87	44	1.73
A306EDS	6 mm	10	0.39	19	0.75	44	1.73
A308EDS	8 mm	14	0.55	20	0.79	42	1.65
A310EDS	10 mm	17	0.65	20	0.79	42	1.65
A312EDS	12 mm	20	0.79	20	0.79	42	1.65
A314EDS	14 mm	22	0.87	20	0.79	42	1.65
A316EDS	16 mm	25	0.98	20	0.79	45	1.77
A318EDS	18 mm	27	1.06	20	0.79	45	1.77

1/2" Square Drive							
A412EDS	1/2"	19	0.75	25	0.98	50	1.97
A413EDS	13 mm	22	0.85	25	0.98	52	2.05
A414EDS	14 mm	23	0.89	25	0.98	52	2.05
A415EDS	15 mm	24	0.93	25	0.98	52	2.05
A416EDS	16 mm	25	0.98	25	0.98	52	2.05
A417EDS	17 mm	28	1.10	28	1.10	54	2.13
A418EDS	18 mm	29	1.14	28	1.10	54	2.13
A419EDS	19 mm	30	1.18	28	1.10	54	2.13

3/4" Square Drive							
A61-1/8EDS	1-1/8"	44	1.73	44	1.73	64	2.52
A61-1/4EDS	1-1/4"	49	1.91	44	1.73	66	2.60
A61-1/2EDS	1-1/2"	57	2.24	44	1.73	68	2.68
A618EDS	18 mm	31	1.22	44	1.73	60	2.36
A624EDS	24 mm	40	1.52	40	1.73	65	2.36

1" Square Drive							
A815/16EDS	15/16"	38	1.50	54	2.13	69	2.72
A8100EDS	100 mm	136	5.35	76	2.99	120	4.72

ERGO-DRIVE® EXTENSIONS

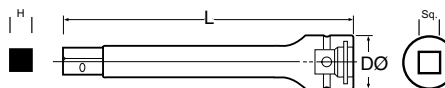

PART NO	SQ DRIVE	H	L MM	L IN	D MM	D IN
---------	-------------	---	---------	---------	---------	---------

3/8" Square Drive						
A352EDE	3/8"	3/8"	52	2.05	20	0.79
A3100EDE	3/8"	3/8"	100	3.94	20	0.79
A375EDE	3/8"	3/8"	75	2.95	20	0.79
A3150EDE	3/8"	3/8"	150	5.91	20	0.79
A3190EDE	3/8"	3/8"	190	7.48	20	0.79
A3254EDE	3/8"	3/8"	254	10.00	20	0.79
A3300EDE	3/8"	3/8"	300	11.81	20	0.79
A3320EDE	3/8"	3/8"	320	12.60	20	0.79

1/2" Square Drive						
A464EDE	1/2"	1/2"	64	2.52	28	1.10
A476EDE	1/2"	1/2"	76	2.99	28	1.10
A4125EDE	1/2"	1/2"	125	4.92	28	1.10
A4204EDE	1/2"	1/2"	204	8.03	28	1.10
A4254EDE	1/2"	1/2"	254	10.00	28	1.10
A4355EDE	1/2"	1/2"	355	13.98	28	1.10

3/4" Square Drive						
A676EDE	3/4"	3/4"	76	2.99	40	1.58
A6100EDE	3/4"	3/4"	100	3.94	40	1.58
A6150EDE	3/4"	3/4"	150	5.91	40	1.58
A6200EDE	3/4"	3/4"	200	7.87	40	1.58

1" Square Drive						
A8150EDE	1"	1"	150	5.91	54	2.13
A8200EDE	1"	1"	200	7.87	54	2.13

QUICK CHANGE CHUCKS



PART NO	SQUARE DRIVE	HEX
---------	--------------	-----

3/8" Square Drive		
ADC-3SEDSQ	3/8"	1/4"
ADC-3SEDSQH7/16	3/8"	7/16"

1/2" Square Drive		
ADC-4SEDSQ	1/2"	1/4"
ADC-4SEDSQH7/16	1/2"	7/16"

Additional types and sizes of fastener tools, as well as custom parts, are available upon request. 1-800-852-1368.

CUSTOM BITS, SOCKETS, AND EXTENSIONS

CUSTOM BITS, SOCKETS, AND EXTENSIONS FOR THE POWER TOOL USER

AIMCO can provide specials for virtually any application. From design to delivery, AIMCO's quick response ensures high quality, tight tolerance specials.

Specials are available in every style including:

- Deep Socket
- Extended Socket
- Universal
- Allen Head
- Torx Head
- Socket Adapter
- Nut Runner Socket
- Nut Runner Joint
- Nutsetter
- Magnetic Nutsetter
- Universal Nutsetter
- Screwdriver Bits



Sample request forms are shown. Your detailed requirements will allow AIMCO to quickly respond with custom solutions for your fastening requirements.

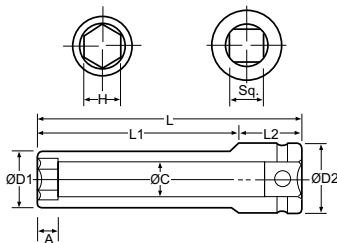

MAGNET		
MP	MT	MS
•	•	•
•	•	•

SOCKET

	H	L	L ₁	L ₂	A	ØC	ØD ₁	ØD ₂	Sq.
SIZE	•	•	•	•	•	•	•	•	•
TYPE	•	•	•	•	•	•	•	•	•

SPECIAL PARTS

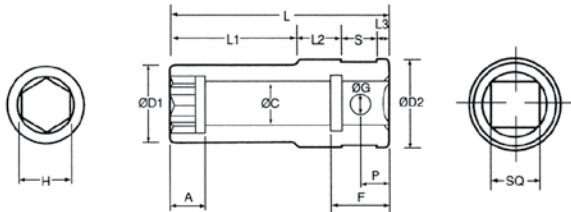

NUTRUNNER SOCKET TYPE A

Min. Qty. 10

Magnet MP MT MS	H	L	L ₁	L ₂	L ₃	S	ØD ₁	A	ØC	ØG	P	F	ØD ₂	Sq.	Qty.
SIZE															
TYPE															

✓ Box for Ergo-Drive

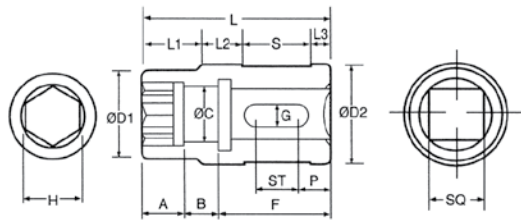

NUTRUNNER SOCKET TYPE B

Min. Qty. 10

H	L	L ₁	L ₂	L ₃	S	ØD ₁	A	B	ØC	G	P	F	ST	ØD ₂	Sq.	Qty.
SIZE																
TYPE																

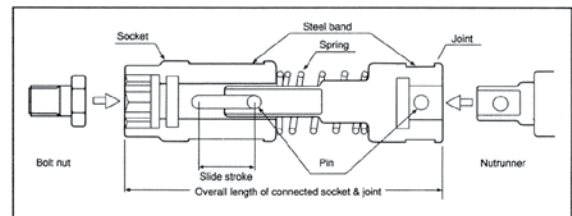
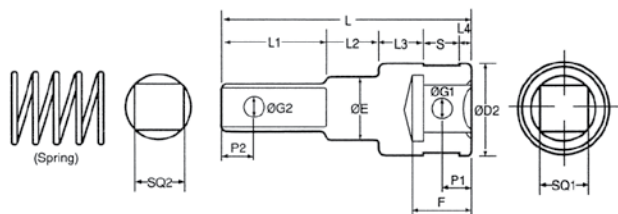

NUTRUNNER JOINT TYPE B

Min. Qty. 10

SQ ₂	L	L ₁	L ₂	L ₃	L ₄	S	P ₁	ØG ₂	ØE	F	ØG ₁	P ₂	ØD ₂	SQ ₁	Qty.

✓ Box for Ergo-Drive

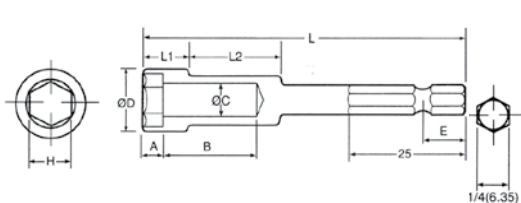

NUT SETTER

Min. Qty. 10

H	ØD	L	E	L ₁	L ₂	A	B	ØC	Qty.
SIZE									
TYPE									

SPECIAL PARTS

MAGNETIC STYLES:

MP (Press-inserted) Type

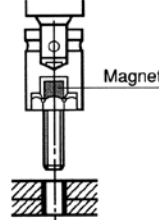

MS (Sliding) Type

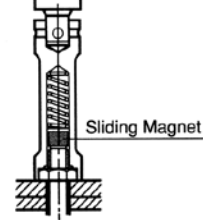

MT (Tube) Type

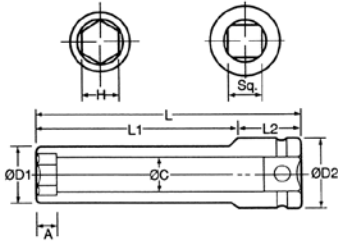
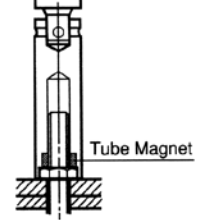

SOCKET

Min. Qty. 10

Magnet			H	L	L ₁	L ₂	A	ØC	ØD ₁	ØD ₂	Sq.	Qty.
MP	MT	MS	SIZE									
			TYPE									

√ Box for Ergo-Drive

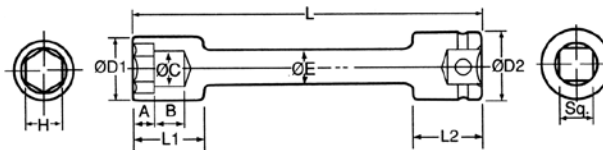

EXTENSION SOCKET

Min. Qty. 10

Magnet			H	L	L ₁	L ₂	A	B	ØC	ØD ₁	ØD ₂	ØE	Sq.	Qty.
MP	MT	MS	SIZE											
			TYPE											

√ Box for Ergo-Drive

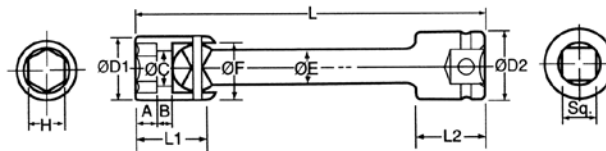

UNIVERSAL SOCKET

Min. Qty. 10

Magnet			H	L	L ₁	L ₂	A	B	ØC	ØD ₁	ØD ₂	ØE	ØF	Sq.	Qty.
MP	MT	MS	SIZE												
			TYPE												

√ Box for Ergo-Drive

ALLEN HEAD/TORX HEAD

Min. Qty. 10

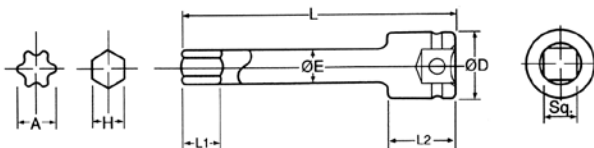

Torx	H	L	L ₁	L ₂	ØD	ØE	Sq.	Qty.

√ Box for Ergo-Drive

SOCKET ADAPTER

Min. Qty. 10

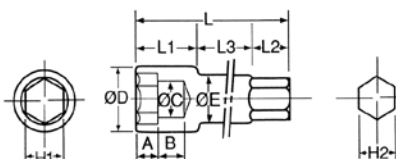

H ₁	L	L ₁	L ₂	L ₃	ØD	A	B	ØC	ØE	H ₂	Qty.

SPECIAL PARTS

(MP) MAGNETIC NUT SETTER

Min. Qty. 10

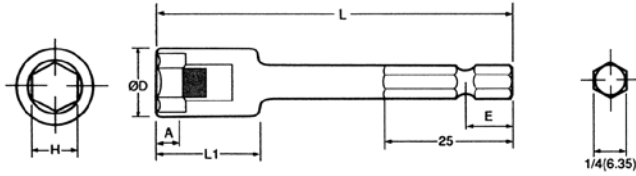

	H	L	E	L ₁	øD	A	Qty.
SIZE							
TYPE							

(MS) MAGNETIC NUT SETTER

Min. Qty. 10

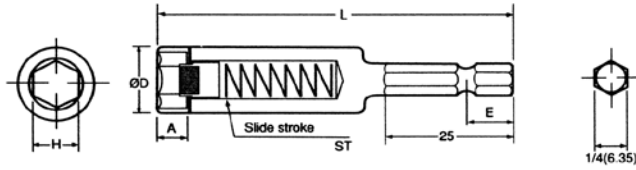

	H	L	E	øD	A	ST	Qty.
SIZE							
TYPE							

(MT) MAGNETIC NUT SETTER

Min. Qty. 10

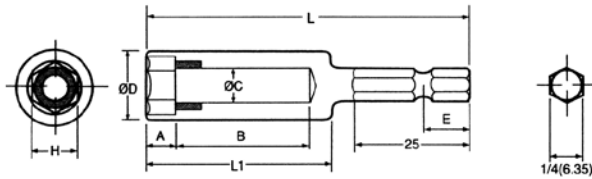

	H	L	E	L ₁	øD	A	B	øC	Qty.
SIZE									
TYPE									

UNIVERSAL NUT SETTER

Min. Qty. 10

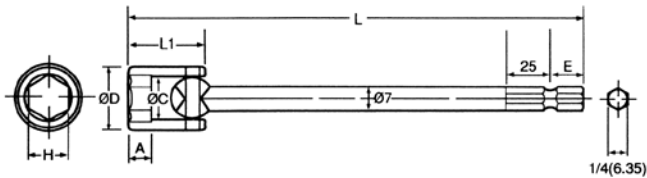

	H	L	E	L ₁	A	øC	øD	Qty.

SCREWDRIVER BIT

Min. Qty. 500

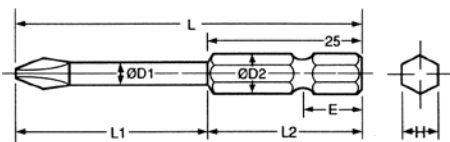

Point Size	L	L ₁	L ₂	øD ₁	øD ₂	E	H	Qty.

CIRCLE ONE:



CONVERSION CHARTS

Fraction ■ Decimal ■ Metric Conversions (to .32)

	Decimal	mm		Decimal	mm		Decimal	mm		Decimal	mm
1/32	.03125	.7938	9/32	.28125	7.1438	17/32	.53125	13.4938	25/32	.78125	19.8438
1/16	.0625	1.5875	5/16	.3125	7.9375	9/16	.5625	14.2875	13/16	.8125	20.6375
3/32	.09375	2.3812	11/32	.34375	8.7312	19/32	.59375	15.0812	27/32	.84375	21.4312
1/8	.125	3.175	3/8	.375	9.525	5/8	.625	15.875	7/8	.875	22.225
5/32	.15625	3.9688	13/32	.40625	10.3188	21/32	.65625	16.6688	29/32	.90625	23.0188
3/16	.1875	4.7625	7/16	.4375	11.1125	11/16	.6875	17.4625	15/16	.9375	23.8125
7/32	.21875	5.5562	15/32	.46875	11.9062	23/32	.71875	18.2562	31/32	.96875	24.6062
1/4	.25	6.35	1/2	.5	12.7	3/4	.75	19.05	1	1.0	25.4

Thread Size to Hex Size



	MM		MM	UNC	INCHES	SAE	INCHES
M 2	4	M 27	41	1/4	7/16	1/4	7/16
M 2.3	4.5	M 30	46	5/16	1/2	5/16	1/2
M 2.6	5	M 33	50	3/8	9/16	3/8	9/16
M 3	5.5	M 36	55	7/16	11/16	7/16	5/8
M 3.5	6	M 39	60	1/2	3/4	1/2	3/4
M 4	7	M 42	65	9/16	7/8	9/16	7/8
M 5	8	M 45	70	5/8	15/16	5/8	15/16
(M 5-6)	9	M 48	75	3/4	1-1/8	3/4	1-1/16
M 6	10	M 52	80	7/8	1-5/16	7/8	1-1/4
M 7	11	M 56	85	1	1-1/2	1-1/8	1-7/16
M 8	13	M 60	90	1-1/8	1-11/16	1-1/4	1-13/16
(M 8)	14	M 64	95	1-1/4	1-7/8	1-3/8	2
M 10	16	M 68	100	1-3/8	2-1/16	1-1/2	2-3/16
(M 10)	17	M 72	105	1-1/2	2-1/4		
M 12	18	M 76	110	1-3/4	2-5/8		
(M 12)	19	M 80	115	2	3		
M 14	21	M 85	120	2-1/4	3-3/8		
(M 14)	22	M 90	130	2-1/2	3-3/4		
M 16	24	M 95	135				
M 18	27	M 100	145				
M 20	30	M 105	150				
(M 22)	32	M 110	155				
M 22	34	M 115	165				
M 24	36	M 120	170				

Torque Conversion Factors

Units to be	SAE			METRIC			INTERNATIONAL SYSTEM - S.I.		
Converted	ozf-in	lbf-in	lbf-ft	gf-cm	kgf-cm	kgf-m	mNm	cNm	Nm
1 ozf-in	= 1	0.0625	0.005	72	0.072	0.0007	7.062	0.706	0.007
1 lbf-in	= 16	1	0.083	1152.1	1.152	0.0115	113	11.3	0.113
1 lbf-ft	= 192	12	1	13826	13.83	0.138	1356	135.6	1.356
1 gf-cm	= 0.014	0.0009	0.00007	1	0.001	0.00001	0.098	0.01	0.0001
1 kgf-cm	= 13.89	0.868	0.072	1000	1	0.01	98.07	9.807	0.098
1 kgf-m	= 1389	86.8	7.233	100000	100	1	9807	980.7	9.807
1 mN-m	= 0.142	0.009	0.0007	10.2	0.01	0.0001	1	0.1	0.001
1 cN-m	= 1.42	0.088	0.007	102	0.102	0.001	10	1	0.01
1 N-m	= 141.6	8.851	0.738	10197	10.20	0.102	1000	100	1



Visit our *NEW* website
WWW.AIMCO-GLOBAL.COM

AIMCO CORPORATE HEADQUARTERS

10000 SE Pine Street
Portland, Oregon 97216
Phone: (503) 254-6600
Toll Free: 1-800-852-1368

AIMCO CORPORATION DE MEXICO SA DE CV

Ave. Cristobal Colon 14529
Chihuahua, Chihuahua. 31125
Mexico
Phone: (01-614) 380-1010
Fax: (01-614) 380-1019

AIMCO EUROPE

C/ Río Gallo, 431 urb. Montelar
19174 Galápagos / Guadalajara
Spain
Phone: +34 673 34 99 25

AIMCO CHINA

Room 607, No. 3998 Hongxin Rd
Minhang District, Shanghai
China
Phone: 0086-21-34319246
Fax: 0086-21-34319245

AIMCO SOUTH AMERICA

Carrera 29A, #7B-91. Origami Building. Int604
Medellin; Colombia 050021

FASTENER