

FASTENER TOOLS *2025*

Standard Fastener Tools

STANDARD FASTENER TOOLS

Connect your tool to the application with Bits, Sockets, and Nutsetters from AIMCO

AIMCO has assembled a complete package of commonly used screwdriver bits and nutsetters. Our goal is to supply you with the highest quality bits and nutsetters for your fastener needs. Whether you're in electronics, aerospace, automotive, or general industry, AIMCO has the bits and nutsetters to fit your needs.

MAG-O-NETS®: A Revolutionary Way to Convert Standard Bits to Magnetic Bits

FEATURES AND BENEFITS

- Easy, cost effective alternative to traditional magnetic bit holder and insert bit combination
- Improves torque transfer by eliminating "wobble effect"
- Easily adjust magnetic attraction by moving Mag-O-Net collar closer to or further from fastener
- Fits virtually any standard screwdriver bit
- Reusable and interchangeable – once a bit is worn out, simply remove your Mag-O-Net and slide it onto the next bit
- Lifetime guarantee on magnetic attraction



*U.S. Patent 5861789

Part No	Inner Diameter (Id)	Outer Diameter (OD)	L MM
AM1/4Z	7 mm	19 mm	10
AM5Z	6 mm	17,5 mm	10
AM3/16Z	3/16 in	17,5 mm	10
AM5/16Z	5/16 in	20 mm	10

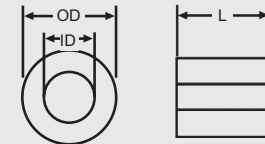

INK MARKING SOCKETS



AxxxxxPAM Series Ink Marking Sockets

Marking Sockets leave a witness mark of ink when the driving socket makes contact with the fastener being tightened. This eliminates the need to come back with a pen to manually mark the bolt.

Socket consists of

- Driving Socket
- Felt pad that holds ink when impregnated

Ink typically supplied by the user to match their color schemes.

To order, contact an AIMCO Customer Service Associate 1-503-254-6600, or toll free 1-800-852-1368.



Bolt



Nut

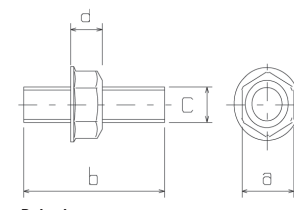
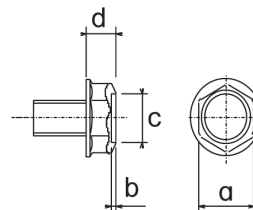

Standard Fastener Tools

IMPACT SOCKETS

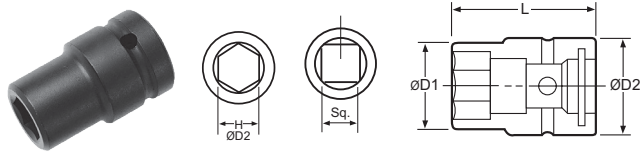

	Part No	Hex	D1 MM	D1 IN	D2 MM	D2 IN	L MM	L IN
SAE	3/8" Square Drive							
	A31/4	1/4"	10	0.39	19	0.75	34	1.34
	A35/16	5/16"	12	0.47	19	0.75	34	1.34
	A33/8	3/8"	15	0.59	19	0.75	34	1.34
	A306	6 mm	10	0.39	19	0.75	34	1.34
	A307	7 mm	13	0.49	20	0.79	32	1.26
Metric	A308	8 mm	14	0.55	20	0.79	32	1.26
	3/8" Square Drive, Deep							
	A307-2	7 mm	13	0.49	20	0.79	50	1.97
	A307-2.75	7 mm	13	0.49	20	0.79	70	2.76
	A308-2	8 mm	14	0.55	20	0.79	50	1.97
SAE	3/8" Square Drive, Magnetic							
	A31/4MP	1/4"	10	0.39	19	0.75	34	1.34
	A35/16MP	5/16"	12	0.47	19	0.75	34	1.34
	A33/8MP	3/8"	15	0.59	19	0.75	34	1.34
	A308MP	8 mm	14	0.55	20	0.79	32	1.26
	A310MP	10 mm	17	0.65	20	0.79	32	1.26
Metric	A311MP	11 mm	17	0.65	19	0.75	34	1.34
	1/2" Square Drive							
SAE	A43/8	3/8"	16	0.63	25	0.98	38	1.50
	A47/16	7/16"	18	0.69	25	0.98	38	1.50
	A41/2	1/2"	19	0.75	25	0.98	50	1.97
Metric	A408	8 mm	16	0.61	25	0.98	40	1.58
	A409	9 mm	16	0.63	25	0.98	40	1.58
	A410	10 mm	18	0.69	25	0.98	40	1.58
	1/2" Square Drive, Deep							
SAE	A43/8-3.25	3/8"	17	0.67	25	0.98	82	3.23
	A47/16-3.25	7/16"	19	0.73	25	0.98	82	3.23
	A41/2-3.25	1/2"	22	0.85	25	0.98	82	3.23

	Part No	Hex	D1 MM	D1 IN	D2 MM	D2 IN	L MM	L IN
Metric	A410-2	10 mm	18	0.69	25	0.98	50	1.97
	A410-3	10 mm	18	0.69	25	0.98	75	2.95
	A410-3.25	10 mm	17	0.67	25	0.98	82	3.23
	A411-3.25	11 mm	19	0.73	25	0.98	82	3.23
1/2" Square Drive, Magnetic								
	A408MP	8 mm	16	0.61	25	0.98	40	1.58
	A410MP	10 mm	18	0.69	25	0.98	40	1.58
	A412MP	12 mm	21	0.81	25	0.98	40	1.58
SAE	3/4" Square Drive							
	A611/16	11/16"	30	1.18	44	1.73	50	1.97
	A63/4	3/4"	32	1.26	44	1.73	50	1.97
	A613/16	13/16"	35	1.38	44	1.73	50	1.97
	A614	14 mm	24	0.95	38	1.50	55	2.17
	A616	16 mm	27	1.06	44	1.73	50	1.97
Metric	A617	17 mm	30	1.18	38	1.50	55	2.17
	3/4" Square Drive, Deep							
SAE	A611/16-4	11/16"	31	1.22	44	1.73	100	3.94
	A63/4-4	3/4"	33	1.30	44	1.73	100	3.94
	A613/16-4	13/16"	36	1.42	44	1.73	100	3.94
Metric	A617-4	17 mm	31	1.22	44	1.73	100	3.94
	A618-4	18 mm	32	1.26	44	1.73	100	3.94
	A619-4	19 mm	33	1.30	38	1.50	100	3.94
	1" Square Drive							
SAE	A87/8	7/8"	37	1.46	54	2.13	59	2.32
	A815/16	15/16"	38	1.50	54	2.13	59	2.32
	A81	1"	41	1.61	54	2.13	59	2.32
	A817	17 mm	31	1.22	50	1.97	63	2.48
Metric	A819	19 mm	33	1.30	50	1.97	63	2.48
	A821	21 mm	37	1.46	50	1.97	63	2.48

Additional types and sizes of fastener tools, as well as custom parts, are available upon request. Contact an AIMCO Customer Service Associate at 1-503-254-6600, or toll free 1-800-852-1368.

ANTI-MARRING SOCKETS

AIMCO's anti-marring sockets have a protective resin cover that spins freely, preventing damage to application surfaces, and protecting fingers.



CV Series



CVF Series



CVF Series
with Bit Attachment



Standard Fastener Tools

UNIVERSAL SOCKETS

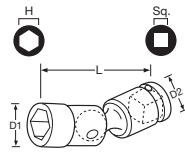

Part No	Hex	D1 MM	D1 IN	D2 MM	D2 IN	L MM	L IN
3/8" Square Drive							
A310U	10 mm	16	0.63	20	0.79	55	2.17
A311U	11 mm	16	0.63	20	0.79	60	2.36
1/2" Square Drive							
A412U	12 mm	20.5	0.81	25	0.98	70	2.76
A413U	13 mm	19	0.75	24	0.95	70	2.76

QUICK CHANGE CHUCKS



Part No	Sq Drive	Hex	D1 MM	D1 IN	L MM	L IN
ADC-2S	1/4"	1/4"	19	0.75	38	1.50
ADC-3S	3/8"	1/4"	20	0.79	42	1.65
ADC-4S	1/2"	1/4"	19	0.75	46	1.81
ADC-3SH7/16Z	3/8"	7/16"	25	0.98	46	1.81
ADC-4SH7/16Z	1/2"	7/16"	33	1.30	55	2.17

ALLEN SOCKETS

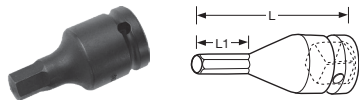

Part No	Hex	L1 MM	L1 IN	L MM	L IN
3/8" Square Drive					
A31/4C	1/4"	10	0.39	42	1.65
A304C	4 mm	10	0.39	42	1.65
1/2" Square Drive					
A41/4C	1/4"	25	0.98	50	1.97
A405C	5 mm	25	0.98	50	1.97

EXTENSIONS

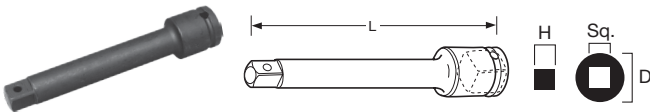

Part No	Sq Drive	Hex	L MM	L IN	D MM	D IN
A375E	3/8"	3/8"	75	2.95	20	0.79
A405E	1/2"	1/2"	51	2.01	30	1.18
A610E	3/4"	3/4"	100	3.94	44	1.73
A810E	1"	1"	102	4.02	54	2.13
A1220E	1-1/4"	1-1/4"	200	7.87	60	2.36
A1418E	1-1/2"	1-1/2"	178	7.01	84	3.31
A2426E	2-1/2"	2-1/2"	264	10.39	137	5.39

NUTSETTERS

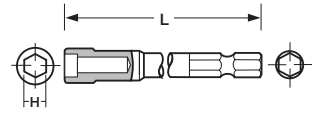

PART NO	HEX	L MM	L IN
A3B1/4-2	1/4"	50	1.97
A3B1/4-2.5	1/4"	63	2.50
A3B5/16-2	5/16"	50	1.97
A3B5/16-2.5	5/16"	63	2.50
A3B3/8-2	3/8"	50	1.97
A3B3/8-2.5	3/8"	63	2.50
A3B05-2.75	5 mm	70	2.76
A3B55-1.2	5.5 mm	30	1.18
A3B55-2.75	5.5 mm	70	2.76
A3B55-4	5.5 mm	100	3.94
A3B06-2.75	6 mm	70	2.76
A3B07-1.2	7 mm	30	1.18
A3B07-2	7 mm	50	1.97
A3B07-2.75	7 mm	70	2.76
A3B07-4	7 mm	100	3.94
A3B08-1.2	8 mm	30	1.18
A3B08-2	8 mm	50	1.97
A3B08-2.75	8 mm	70	2.76
A3B08-4	8 mm	100	3.94
A3B08-6	8 mm	150	5.91
A3B08-8	8 mm	200	7.87
A3B09-2.75	9 mm	70	2.76
A3B09-4	9 mm	100	3.94
A3B10-1.2	10 mm	30	1.18
A3B10-2	10 mm	50	1.97
A3B10-2.75	10 mm	70	2.76
A3B11-2.75	11 mm	70	2.76
A3B12-1.2	12 mm	30	1.18
A3B13-2.75	13 mm	70	2.76
A3B14-2.75	14 mm	70	2.76
A3B16-2.75	16 mm	70	2.76
A3B17-2.75	17 mm	70	2.76

SOCKET ADAPTERS

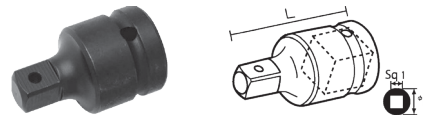

Part No	Female Sq. Drive	Male Sq. Drive	D MM	D IN	L MM	L IN
A302A	3/8"	1/4"	22	0.87	35	1.38
A403A	1/2"	3/8"	25	0.98	37	1.46
A504A	5/8"	1/2"	35	1.38	47	1.46
A604A	3/4"	1/2"	38	1.50	53	2.09
A806A	1"	3/4"	50	1.97	70	2.76
A128A	1-1/4"	1"	60	2.36	76	2.99
A#508A	Spline #5	1"	60	2.36	90	3.54

Additional types and sizes of fastener tools, as well as custom parts, are available upon request. Contact an AIMCO Customer Service Associate at 1-503-254-6600, or toll free 1-800-852-1368.

Standard Fastener Tools

PHILLIPS POWER BITS

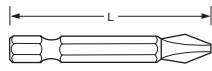

Part No	Point Size	L MM	L IN
A3S0-2	0	50	1.97
A3S1-2	1	50	1.97
A3S1-2.75	1	70	2.76
A3S1-3	1	75	2.95
A3S1-3.5	1	90	3.54
A3S1-4	1	100	3.94
A3S1-6	1	150	5.91
A3S2-1.2	2	30	1.18
A3S2-1.6	2	40	1.57
A3S3-2	3	50	1.97
A3S3-2.75	3	70	2.76

Double-Ended

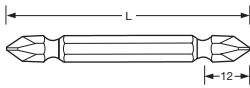

A3W1-3	1	75	2.94
A3W2-2	2	50	1.97
A3W2-3	2	75	2.94
A3W2-4	2	100	3.94
A3W2-6	2	150	5.91
A3W2-8	2	200	7.87
A3W2-10	2	250	9.84
A3W2-12	2	300	11.81
A3W3-2	3	50	1.97
A3W3-3	3	75	2.94
A3W3-4	3	100	3.94
A3W3-6	3	150	5.91
A3W3-8	3	200	7.87

TORX POWER BITS

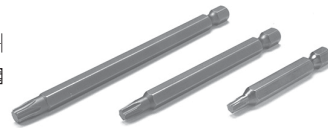
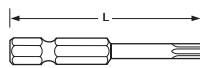

Part No	Torx Size	L MM	L IN
A3T6-2	T6	50	1.97
A3T7-2	T7	50	1.97
A3T7-2.75	T7	70	2.76
A3T7-3.5	T7	90	3.54
A3T7-6	T7	150	5.91
A3T8-2	T8	50	1.97
A3T9-2.75	T9	70	2.76

BIT HOLDERS

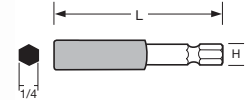

Part No	L MM	L IN
1/4" Hex, Magnetic		
A3BHM-3	75	2.94
A3BHM-4	100	3.94
A3BHM-6	150	5.91
A3BHM-8	200	7.87
A3BHM-10	250	9.84

Bit and Nutsetter Part Number Nomenclature

Precedes Part Number

BITS	A7 = 7/16 Power Drive
A3S = Phillips® Power Drive	AS = Electric Type Phillips®
A3W = Double Ended Phillips®	AM = Electric Type Slotted
A38S = Phillips® Insert	ATW = Electric Type Tri-Wing®
A39S = Phillips® Insert	AT = Electric Hios Type Reduced Nose
A3M = Slotted Power Drive	A26S = Electric Driver Phillips®
A38M = Slotted Insert	A26M = Electric Driver Slotted
A3MT = Slotted Power Drive Reduced Nose	A26C = Electric Driver Allen Socket Head
A3C = Allen Socket Head Power Drive	A3BHM = Insert Bit Holder (Magnetic Type)
A38C = Allen Socket Head Insert	A3BHD = Insert Bit Holder (Non Magnetic)
A3R = Square Recess Power Drive	
A3RT = Square Recess Turned Down (Power)	
A38R = Square Recess Insert	NUTSETTERS
A3T = Torx® Power Drive	A3B = Nutsetter
A38T = Torx® Insert	A3BMP = Magnetic (MP) Pressed Type
A3TS = Torq-Set® Power Drive	A3BMS = Magnetic (MS) Spring Loaded
A38TS = Torq-Set® Insert	A3BMT = Magnetic (MT) Tube Type
A3TA = Triangle Power Drive	A3BU = Universal Nutsetter
A3TW = Tri-Wing® Power Drive	
A38TW = Tri-Wing® Insert	MAG-0-NETS
	AM = AIMCO Mag-0-Net®

Contained within Part Number

BITS	
PZ = Pozidriv®	
PZACR = Pozidriv® ACR®	
SDV = Supadriv®	
TR = Torx® Tamper Resistant	
ACRI = ACR® Installation	
ACR = ACR® Remove	
ACRB = ACR® 4x4 Both Install and Remove	
E4 = Electric 4 mm diameter	
E5 = Electric 5 mm diameter	
RS = Reduced Shank	

Additional types and sizes of fastener tools, as well as custom parts, are available upon request. Contact an AIMCO Customer Service Associate at 1-503-254-6600, or toll free 1-800-852-1368.

Ergo-Drive Series

ERGO-DRIVE® SOCKETS PROTECT...

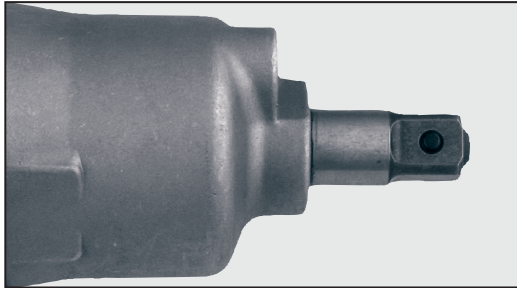

...YOUR INVESTMENT!

Pulse tools are an investment and the anvil is the most expensive single part of any pulse tool. ERGO-DRIVE sockets decrease vibration and wear on this critical component.

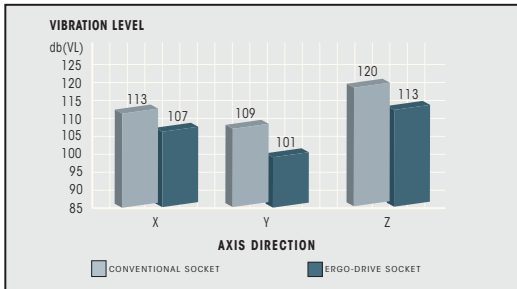
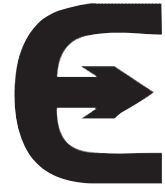

...YOUR ASSEMBLERS!

ERGO-DRIVE sockets cause significantly less vibration during fastening than conventional sockets. This allows your assemblers to do their jobs without the worry of vibration related injuries.

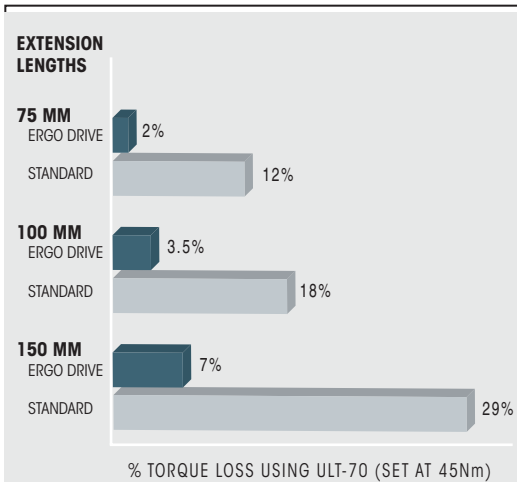

...YOUR PRODUCTS!

By reducing run-out and vibration, ERGO-DRIVE sockets allow the most repeatable, accurate rundowns to take place, ensuring excellent product quality.



ERGO-DRIVE VS. STANDARD

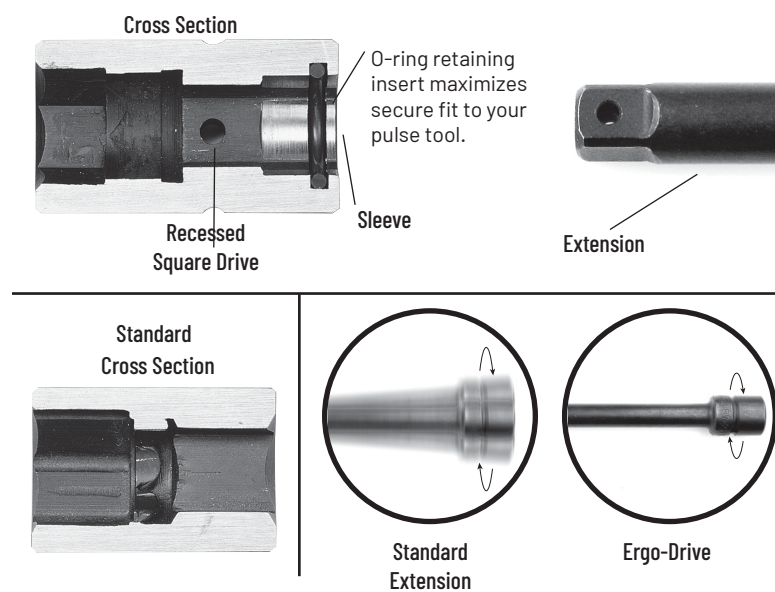

Ergo-Drive Fastener Tools

ERGO-DRIVE SOCKETS

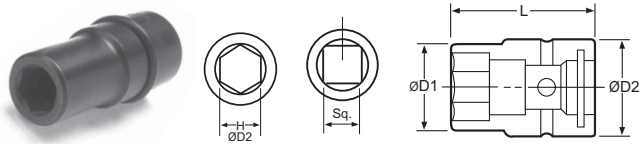

Part No	Hex	D1 MM	D1 IN	D2 MM	D2 IN	L MM	L IN
---------	-----	----------	----------	----------	----------	---------	---------

3/8" Square Drive

A31/4EDS	1/4"	10	0.39	19	0.75	44	1.73
A31/2EDS	1/2"	20	0.77	22	0.87	44	1.73
A306EDS	6 mm	10	0.39	19	0.75	44	1.73
A308EDS	8 mm	14	0.55	20	0.79	42	1.65
A310EDS	10 mm	17	0.65	20	0.79	42	1.65
A312EDS	12 mm	20	0.79	20	0.79	42	1.65
A314EDS	14 mm	22	0.87	20	0.79	42	1.65
A316EDS	16 mm	25	0.98	20	0.79	45	1.77
A318EDS	18 mm	27	1.06	20	0.79	45	1.77

1/2" Square Drive

A41/2EDS	1/2"	19	0.75	25	0.98	50	1.97
A413EDS	13 mm	22	0.85	25	0.98	52	2.05
A414EDS	14 mm	23	0.89	25	0.98	52	2.05
A415EDS	15 mm	24	0.93	25	0.98	52	2.05
A416EDS	16 mm	25	0.98	25	0.98	52	2.05
A417EDS	17 mm	28	1.10	28	1.10	54	2.13
A418EDS	18 mm	29	1.14	28	1.10	54	2.13
A419EDS	19 mm	30	1.18	28	1.10	54	2.13

3/4" Square Drive

A61-1/8EDS	1-1/8"	44	1.73	44	1.73	64	2.52
A61-1/4EDS	1-1/4"	49	1.91	44	1.73	66	2.60
A61-1/2EDS	1-1/2"	57	2.24	44	1.73	68	2.68
A618EDS	18 mm	31	1.22	44	1.73	60	2.36
A624EDS	24 mm	40	1.52	40	1.73	65	2.36

1" Square Drive

A815/16EDS	15/16"	38	1.50	54	2.13	69	2.72
A8100EDS	100 mm	136	5.35	76	2.99	120	4.72

ERGO-DRIVE EXTENSIONS

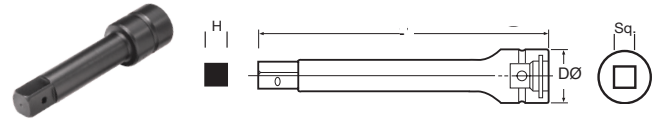

Part No	Sq Drive	H	L MM	L IN	D MM	D IN
---------	-------------	---	---------	---------	---------	---------

3/8" Square Drive

A352EDE	3/8"	3/8"	52	2.05	20	0.79
A3100EDE	3/8"	3/8"	100	3.94	20	0.79
A375EDE	3/8"	3/8"	75	2.95	20	0.79
A3150EDE	3/8"	3/8"	150	5.91	20	0.79
A3190EDE	3/8"	3/8"	190	7.48	20	0.79
A3254EDE	3/8"	3/8"	254	10.00	20	0.79
A3300EDE	3/8"	3/8"	300	11.81	20	0.79
A3320EDE	3/8"	3/8"	320	12.60	20	0.79

1/2" Square Drive

A464EDE	1/2"	1/2"	64	2.52	28	1.10
A476EDE	1/2"	1/2"	76	2.99	28	1.10
A4125EDE	1/2"	1/2"	125	4.92	28	1.10
A4204EDE	1/2"	1/2"	204	8.03	28	1.10
A4254EDE	1/2"	1/2"	254	10.00	28	1.10
A4355EDE	1/2"	1/2"	355	13.98	28	1.10

3/4" Square Drive

A676EDE	3/4"	3/4"	76	2.99	40	1.58
A6100EDE	3/4"	3/4"	100	3.94	40	1.58
A6150EDE	3/4"	3/4"	150	5.91	40	1.58
A6200EDE	3/4"	3/4"	200	7.87	40	1.58

1" Square Drive

A8150EDE	1"	1"	150	5.91	54	2.13
A8200EDE	1"	1"	200	7.87	54	2.13

ERGO-DRIVE QUICK CHANGE CHUCKS



Part No	Square Drive	Hex
---------	--------------	-----

3/8" Square Drive

ADC-3SEDSQ	3/8"	1/4"
ADC-3SEDSQH7/16	3/8"	7/16"

1/2" Square Drive

ADC-4SEDSQ	1/2"	1/4"
ADC-4SEDSQH7/16	1/2"	7/16"

Additional types and sizes of fastener tools, as well as custom parts, are available upon request. Contact an AIMCO Customer Service Associate at 1-503-254-6600, or toll free 1-800-852-1368.

Custom Bits, Sockets, and Extensions

CUSTOM BITS, SOCKETS, AND EXTENSIONS FOR THE POWER TOOL USER

AIMCO can provide specials for virtually any application. From design to delivery, AIMCO's quick response ensures high quality, tight tolerance specials.

Specials are available in every style including:

- Deep Socket
- Extended Socket
- Universal
- Allen Head
- Torx Head
- Socket Adapter
- Nut Runner Socket
- Nut Runner Joint
- Nutsetter
- Magnetic Nutsetter
- Universal Nutsetter
- Screwdriver Bits



Sample request forms are shown. Your detailed requirements will allow AIMCO to quickly respond with custom solutions for your fastening applications.

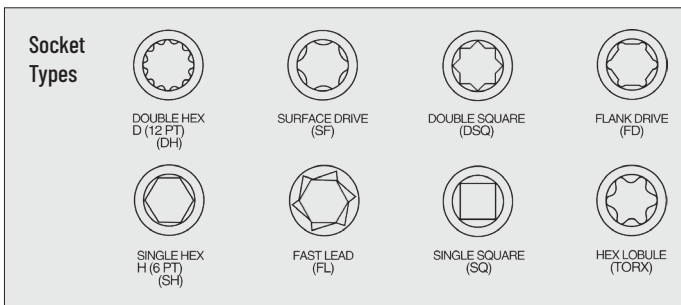

MAGNETIC STYLES:

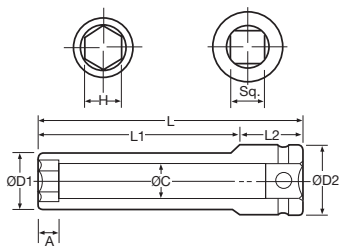
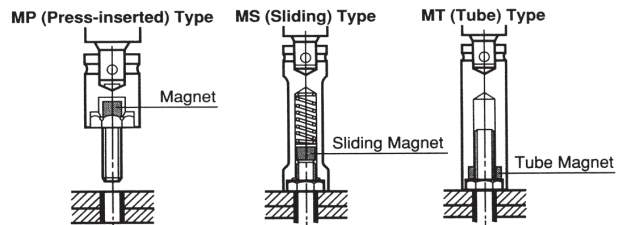

Magnet		
MP	MT	MS

SOCKET

	H	L	L1	L2	A	ØC	ØD1	ØD2	Sq.
SIZE									
TYPE									

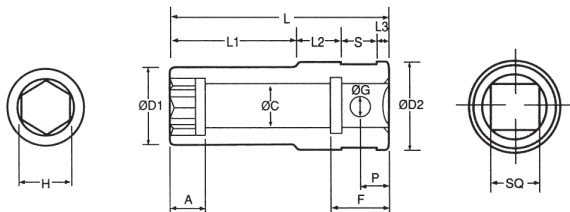

Nutrunner Socket Type A

Magnet			H	L	L1	L2	L3	S	ØD1	A	ØC	ØG	P	F	ØD2	Sq.	Qty.
MP	MT	MS															

Min. Qty 10

✓ box for Ergo Drive

Special Parts

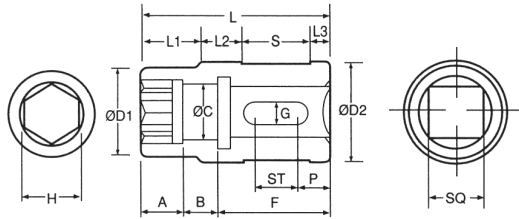

Nutrunner Socket Type B

Min. Qty 10

	H	L	L1	L2	L3	S	ØD1	A	B	ØC	G	P	F	ST	ØD2	Sq.	Qty.
SIZE																	
TYPE																	

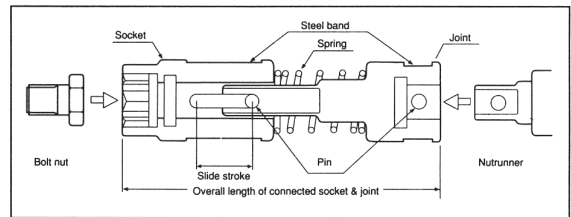
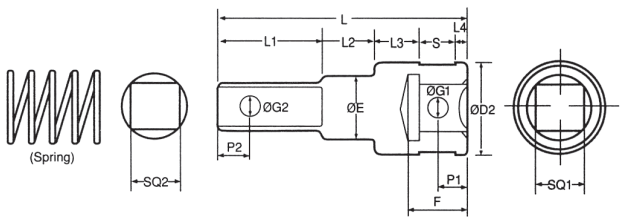

Nutrunner Joint Type B

Min. Qty 10

	SQ2	L	L1	L2	L3	L4	S	P1	ØG2	ØE	F	ØG1	P2	ØD2	SQ1	Qty.
SIZE																
TYPE																

✓ box for Ergo Drive

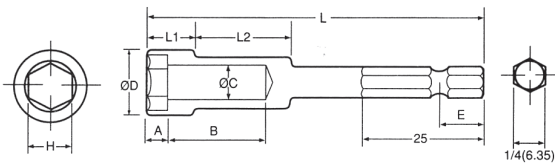

Nutrunner Socket Type B

Min. Qty 10

	H	ØD	L	E	L1	L2	A	B	ØC	Qty.
SIZE										
TYPE										

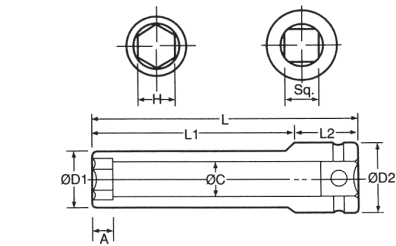

Socket

Min. Qty 10

Magnet			H	L	L1	L2	A	ØC	ØD1	ØD2	Sq.	Qty.
MP	MT	MS										

✓ box for Ergo Drive

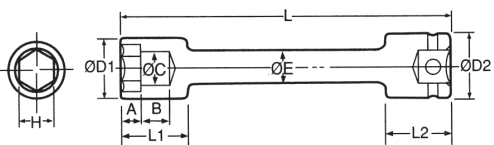

Extension Socket

Min. Qty 10

Magnet			H	L	L1	L2	A	B	ØC	ØD2	ØE	Sq.	Qty.
MP	MT	MS											

✓ box for Ergo Drive

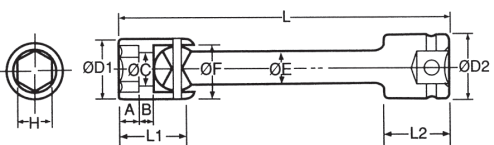

Universal Socket

Min. Qty 10

Magnet			H	L	L1	L2	A	B	ØC	ØD1	ØD2	ØE	ØF	Sq.	Qty.
MP	MT	MS													

✓ box for Ergo Drive

Special Parts

Allen Head / Torx Head

Min. Qty 10

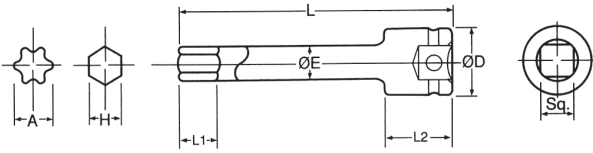

Torx	H	L	L1	L2	ØD	ØE	ØF	Sq.	Qty.
								<input type="checkbox"/>	

✓ box for Ergo Drive

Socket Adapter

Min. Qty 10

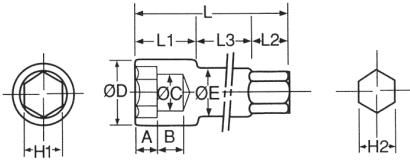

H1	L	L1	L2	L3	ØD	A	B	ØC	ØE	H2	Qty.
SIZE											
TYPE											

(MP) Magnetic Nut Setter

Min. Qty 10

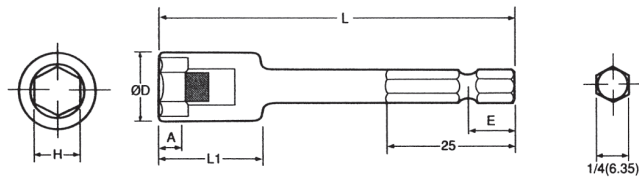

H	L	E	L1	ØD	A	Qty.
SIZE						
TYPE						

(MS) Magnetic Nut Setter

Min. Qty 10

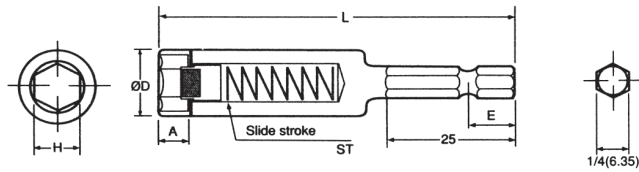

H	L	E	ØD	A	ST	Qty.
SIZE						
TYPE						

(MT) Magnetic Nut Setter

Min. Qty 10

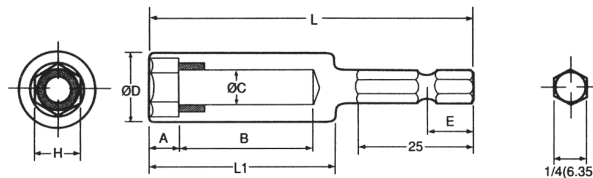

H	L	E	L1	ØD	A	B	ØC	Qty.
SIZE								
TYPE								

Universal Nut Setter

Min. Qty 10

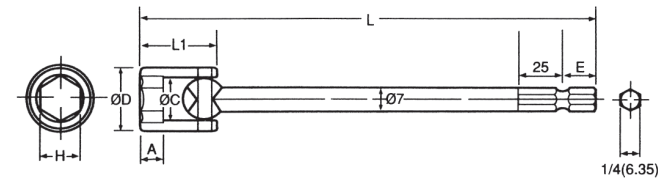

H	L	E	L1	A	ØC	ØD	Qty.

Screwdriver Bit

Min. Qty 500

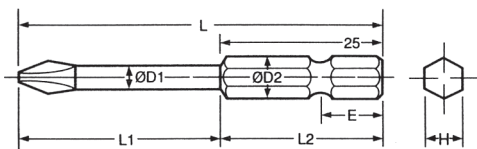

Point Size	L	L1	L2	ØD1	ØD2	E	H	Qty.

CIRCLE ONE:



Phillips®



Slotted



Torx®



Torx®
Tamper Resistant



Pozidriv®



Supadriv®



Square Recess



Allen Head



Torq-Set®







Tri-Wing®

Conversion Charts

Fraction • Decimal • Metric Conversions (to .32)											
	DECIMAL	MM		DECIMAL	MM		DECIMAL	MM		DECIMAL	MM
1/32	.03125	.7938	9/32	.28125	7.1438	17/32	.53125	13.4938	25/32	.78125	19.8438
1/16	.0625	1.5875	5/16	.3125	7.9375	9/16	.5625	14.2875	13/16	.8125	20.6375
3/32	.09375	2.3812	11/32	.34375	8.7312	19/32	.59375	15.0812	27/32	.84375	21.4312
1/8	.125	3.175	3/8	.375	9.525	5/8	.625	15.875	7/8	.875	22.225
5/32	.15625	3.9688	13/32	.40625	10.3188	21/32	.65625	16.6688	29/32	.90625	23.0188
3/16	.1875	4.7625	7/16	.4375	11.1125	11/16	.6875	17.4625	15/16	.9375	23.8125
7/32	.21875	5.5562	15/32	.46875	11.9062	23/32	.71875	18.2562	31/32	.96875	24.6062
1/4	.25	6.35	1/2	.5	12.7	3/4	.75	19.05	1	1.0	25.4

Thread Size to Hex Size

							
METRIC BOLT SIZE	SOCKET HEX SIZE (MM)	METRIC BOLT SIZE	SOCKET HEX SIZE (MM)	UNC BOLT SIZE	SOCKET HEX SIZE (IN)	SAE BOLT SIZE	SOCKET HEX SIZE (IN)
M 2	4	M 27	41	1/4	7/16	1/4	7/16
M 2.3	4.5	M 30	46	5/16	1/2	5/16	1/2
M 2.6	5	M 33	50	3/8	9/16	3/8	9/16
M 3	5.5	M 36	55	7/16	11/16	7/16	5/8
M 3.5	6	M 39	60	1/2	3/4	1/2	3/4
M 4	7	M 42	65	9/16	7/8	9/16	7/8
M 5	8	M 45	70	5/8	15/16	5/8	15/16
(M 5-6)	9	M 48	75	3/4	1-1/8	3/4	1-1/16
M 6	10	M 52	80	7/8	1-5/16	7/8	1-1/4
M 7	11	M 56	85	1	1-1/2	1-1/8	1-7/16
M 8	13	M 60	90	1-1/8	1-11/16	1-1/4	1-13/16
(M 8)	14	M 64	95	1-1/4	1-7/8	1-3/8	2
M 10	16	M 68	100	1-3/8	2-1/16	1-1/2	2-3/16
(M 10)	17	M 72	105	1-1/2	2-1/4		
M 12	18	M 76	110	1-3/4	2-5/8		
(M 12)	19	M 80	115	2	3		
M 14	21	M 85	120	2-1/4	3-3/8		
(M 14)	22	M 90	130	2-1/2	3-3/4		
M 16	24	M 95	135				
M 18	27	M 100	145				
M 20	30	M 105	150				
(M 22)	32	M 110	155				
M 22	34	M 115	165				
M 24	36	M 120	170				

Torque Conversion Factors

UNITS TO BE CONVERTED	=	SAE			METRIC			INTERNATIONAL SYSTEM - S.I.		
		OZF-IN	LBF-IN	LBF-FT	GF-CM	KGF-CM	KGF-M	MNM	CNM	NM
1 ozf-in	=	1	0.0625	0.005	72	0.072	0.0007	7.062	0.706	0.007
1 lbf-in	=	16	1	0.083	1152.1	1.152	0.0115	113	11.3	0.113
1 lbf-ft	=	192	12	1	13826	13.83	0.138	1356	135.6	1.356
1 gf-cm	=	0.014	0.0009	0.00007	1	0.001	0.00001	0.098	0.01	0.0001
1 kgf-cm	=	13.89	0.868	0.072	1000	1	0.01	98.07	9.807	0.098
1 kgf-m	=	1389	86.8	7.233	100000	100	1	9807	980.7	9.807
1 mN-m	=	0.142	0.009	0.0007	10.2	0.01	0.0001	1	0.1	0.001
1 cN-m	=	1.42	0.088	0.007	102	0.102	0.001	10	1	0.01
1 N-m	=	141.6	8.851	0.738	10197	10.20	0.102	1000	100	1



PRINTED IN THE U.S.A.

LIT-AT125, REV 02-12-25, ©2025 AIMCO

AIMCO CORPORATE HEADQUARTERS

10000 SE Pine Street
Portland, Oregon 97216
Phone: (503) 254-6600
Toll Free: 1-800-852-1368

AIMCO CORPORATION DE MEXICO SA DE CV

Ave. Cristobal Colon 14529
Chihuahua, Chihuahua. 31125
Phone: (01-614) 380-1010
Fax: (01-614) 380-1019