



TOOL SUPPORT SYSTEMS *2022*



AIMCO

For more than 50 years, AIMCO has been working with manufacturers around the world. We are the complete global source for all critical fastening and bolting solutions. AIMCO can effectively and swiftly meet your needs whether you're in Tennessee, USA fastening a 3 mm nut at 3 Nm, or in Denmark servicing wind-turbine bolts at 17,000 Nm. AIMCO provides the tools and solutions, on a global scale, that guarantee the success of your project. It is with great pride that AIMCO can say the products that we manufacture are **MADE IN THE USA.**

Visit our website www.aimco-global.com

TABLE OF CONTENTS

TOOL SUPPORT SYSTEMS

Ergo Arms®	4
Linear Arms	6
Jib Arms	7
Carbon Torque Arms.	8
Carbon Torque Tubes	11
GCI Torque Reaction Arms	13
GEN IV Smart Arm System with Process Visualization	16
3arm Zero Gravity Arms	18
Support System Tool-Mounting Options	23
Workstation Components And Assemblies	24
Balancers / Retractors.	26
Air Preparation Units	28
Air Line & Accessories.	29
Index.	31

Ergo Arm Tool Support Systems

ERGO ARMS

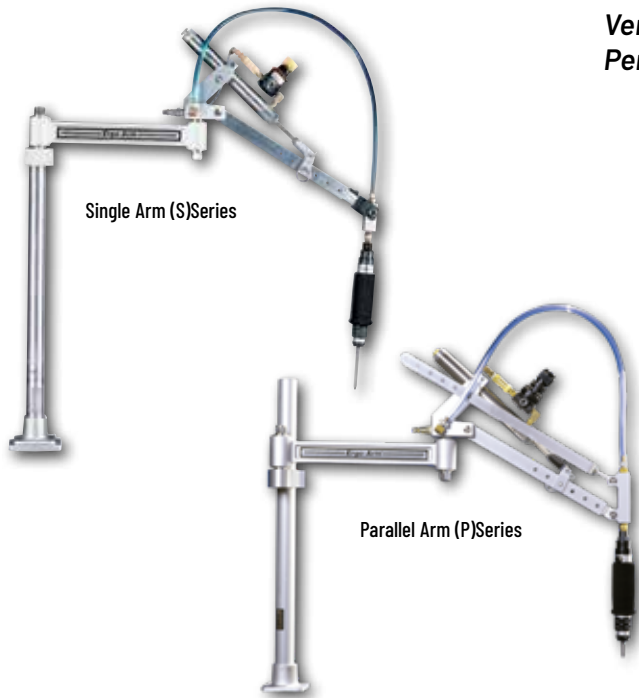

Versatile Ergo Arms Absorb Torque Reaction while Perfectly Balancing Tool Weight

AIMCO's Ergo Arms reduce operator fatigue for electric and pneumatic tools. The versatile, easy-to-assemble kits include both single and parallel rails for customizing tool rigidity to the customer's preference.

The durable, lightweight construction provides minimal resistance and low inertia during high-cycle use. The adjustable height, length, and elbowed joint increases accessibility with minimal travel to the fastening application.

Tools recommended for use with this arm:

- AcraDyne 1000 and 2000 Series
- Uryu LT Series Pneumatic Screwdrivers
- Electra Electric Screwdrivers
- Inline Tools

SPECIAL FEATURES OF ERGO ARMS

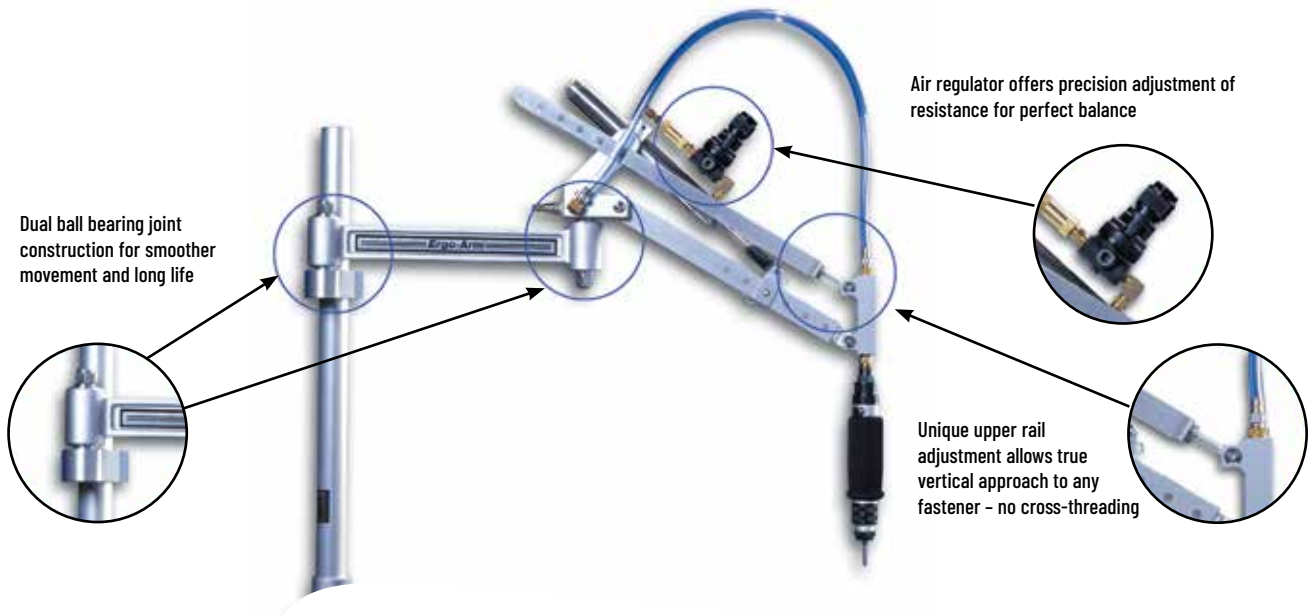

Ergo Arm Tool Support Systems

ERGO ARM FEATURES AND BENEFITS



PARALLEL ARM SERIES

AD-D1098-P, AD-D1098-PAC, AD-D1098-PACE

- Allows for freedom of movement
- Vertical adjustment eliminates cross-threading
- Fixtured tool increases repeatability
- Adjustable reach
- Available in air or oil cylinder models
- Electric tool mount standard on PACE model

SINGLE ARM SERIES

AD-D1098-S, AD-D1098-SAC

- Full tool rotation
- Allows for freedom of movement
- Adjustable reach
- Compatible with automatic screw feeder
- Available in air or oil cylinder models

AD Series Ergo Arms

Model	Arm Style	Tool Mount	Reach		Capacity		Maximum Torque*	
			IN	MM	LB	KG	IN-LB	NM
AIR CYLINDER SERIES								
AD-D1098-SAC	Single	Air manifold	4 - 33	102 - 838	0 - 15	0 - 7	110	12
AD-D1098-PAC	Parallel	Air manifold	4 - 33	102 - 838	0 - 15	0 - 7	110	12
AD-D1098-PACE	Parallel	Electric	4 - 33	102 - 838	0 - 15	0 - 7	110	12
OIL CYLINDER SERIES								
AD-D1098-S	Single	Air manifold**	4 - 33	102 - 838	0 - 15	0 - 7	110	12
AD-D1098-P	Parallel	Air manifold	4 - 33	102 - 838	0 - 15	0 - 7	110	12

* Max torque allowed may be dependent on tool clutch type and joint rate

** For single arm electric tool mount, order EAP-202ED-KIT

Linear Arms

ALA AND AFA SERIES LINEAR ARMS



Ergonomic Support for Electric and Pneumatic Tools Reduces Operator Fatigue

AIMCO's linear arms are lightweight and designed for smooth and easy handling of electric and pneumatic tools. Arms are available in torque ranges of 5 Nm to 400 Nm and with reaches ranging from 12.5 in. to 36 in.

The ALA Series (AIMCO Linear Arm) is constructed with precision linear slides and bearings for precise tool movements. The AFA Series (AIMCO Folding Arm) is configured with aluminum alloy beams connected by an elbow joint for working with tools in tight spaces.

Tools recommended for use with this arm:

- AcraDyne 1000 and 2000 Series
- Uryu LT Series Pneumatic Screwdrivers
- Electra Electric Screwdrivers
- Inline Tools

FEATURES AND BENEFITS

ALA Series

- Constructed of lightweight aluminum
- Improves fastening quality and productivity
- Maintains Perpendicularity of the tool to the application
- Absorbs torque reaction
- Counterbalances tool mass

AFA Series

- All features of the ALA Series
- Folding elbow joint allows for closer reach to post for tight workspaces

ALA & AFA Series Linear Arms

Model	Max. Torque		Max. Tool Weight		Reach		Tool Diameter	
	NM	FT-LB	KG	LB	MM	IN	MM	IN
ALA Series Linear Arm								
ALA5-200	5	3.7	2	4.4	317- 519	12.5 - 20.4	23 - 40	1.0 - 1.6
ALA15-200	15	11.1	3	6.6	317- 519	12.5 - 20.4	23 - 40	1.0 - 1.6
ALA10-400	10	7.4	2	4.4	517- 919	20.4 - 36.2	23 - 40	1.0 - 1.6
ALA40-300	40	29.5	3	6.6	417- 719	16.4 - 28.3	32 - 47	1.3 - 1.9
ALA200-400	200	147.5	10	22.0	517- 919	20.4 - 36.2		
ALA400-400	400	295	20	44.0	517- 919	20.4 - 36.2		
AFA Series With Folding Arm								
AFA5-400	5	3.7	2	4.4	0 - 470	0 - 18.5	23 - 40	1.0 - 1.6
AFA15-400	15	11.1	3	6.6	0 - 470	0 - 18.5	23 - 40	1.0 - 1.6
AFA10-550	10	7.4	2	4.4	0 - 620	0 - 24.2	23 - 40	1.0 - 1.6

Jib Arms

ABMJ SERIES BENCH-MOUNT JIB ARMS



ABMJ Series

Customize Bench-Mount Jib Arms to Meet all Application Requirements

AIMCO's Bench Mount Jibs Arms (ABMJ Series) include a jib, two sliding trolleys, and a base – just attach an AIMCO telescopic or anti-rotation torque arm or torque tube for a completely customized system.

Tools recommended for use with this arm:

- Tool Balancers (ASB/TW Series)
- ACA Series Telescoping Carbon Arms

FEATURES AND BENEFITS

- Constructed of lightweight aluminum
- Two-Point secure for horizontal job for sound structure and safety
- Includes 2 sliding trolleys and base plate for easy mounting
- As many as 4 beams can be attached to a pillar
- Adjustable height adjustment for jib mount



Carbon Arm, Tool, and Balancer shown for concept.

Items sold separately

ABMJ Series Jib Arms

Model	Height		Beam Length		Max. Tool Weight		Pivot Range
	MM	IN	MM	IN	KG	LB	
ABMJ Series - Bench-Mount Jib Arm							
ABMJ 1200-600	1,200	47.2	600	23.6	6	13.2	180°
ABMJ 1200-1000	1,200	47.2	1,000	39.4	6	13.2	180°
ABMJ 2000-1000	1,200	47.2	1,000	39.4	4	8.8	180°

Carbon Torque Arms

ACA SERIES TELESCOPIC CARBON ARMS



Telescopic Torque Reaction Arms Provide Complete Ergonomics in the Hand-Tightening Phase

ACA Series Carbon Arms are lightweight, yet strong devices designed to absorb torque reactive forces. Highly flexible and modular, they adapt to a wide range of tools, and eliminate hazards to operators during fastening processes.

Tools recommended for use with this arm:

- Continuous Drive Electric and Pneumatic Tools
- Pulse Tools
- Screwdrivers

FEATURES AND BENEFITS

- Absorb torque reaction from continuous drive tools
- Counter balance tool weight when configured with AIMCO's wide array of tool balancers or with integrated balancer kits
- Orient tool correctly to the workpiece to improve efficiency and reduce operator effort in alignment to the fastener



ACA80-1500



ACA-V15-1000

ACA Series Carbon Torque Arms

Model	Min. Length MM	Max. Length MM	Max Torque NM
ACA10-1000	495	1,105	10
ACA10-1500	665	1,605	10
ACA15-1000	486	1,066	15
ACA15-1500	646	1,556	15
ACA15-2000	806	2,046	15
ACA40-1000	486	1,066	40
ACA40-1500	646	1,556	40
ACA40-2000	806	2,046	40
ACA40-2500	986	2,576	40
ACA80-1500	658	1,586	80
ACA80-2000	828	2,078	80
ACA80-2500	998	2,588	80
ACA150-1500	668	1,578	150
ACA150-2000	838	1,918	150
ACA150-2500	1003	2,248	150
ACA220-1500	668	1,578	220
ACA220-2000	838	2,088	220
ACA220-2500	1,003	2,588	220

ACA-V Series Carbon Torque Arms

Model	Min. Length MM	Max. Length MM	Max Torque NM
ACA-V15-1000	777	1,345	15
ACA-V15-1500	937	1,835	15
ACA-V15-2000	1,097	2,325	15
ACA-V40-1000	777	1,345	40
ACA-V40-1500	937	1,835	40
ACA-V40-2000	1,097	2,325	40
ACA-V40-2500	1,277	2,855	40
ACA-V80-1500	949	1,865	80
ACA-V80-2000	1,119	2,357	80
ACA-V80-2500	1,289	2,867	80
ACA-V150-1500	960	1,957.5	150
ACA-V150-2000	1,129	2,357	150
ACA-V150-2500	1,294	2,862	150
ACA-V220-1500	960	1,957.5	220
ACA-V220-2000	1,129	2,357	220
ACA-V220-2500	1,294	2,867	220

Carbon Torque Arms

ACA-P2 CARBON SMART ARM



ACA-P2 Series Carbon Torque Smart Arm w/X,Y Axis Encoders

(Requires ACA-POSIX System or AcraDyne's Gen IV Smart Arm System)

Model	Min. Length MM	Max. Length MM	Max Torque NM
ACA-P215-1000	647	1,227	15
ACA-P215-1500	803	1,713	15
ACA-P215-2000	977	2,227	15
ACA-P240-1000	647	1,227	40
ACA-P240-1500	803	1,713	40
ACA-P240-2000	977	2,227	40
ACA-P240-2500	1,157	2,737	40
ACA-P280-1500	830	1,757	80
ACA-P280-2000	1,000	2,249	80
ACA-P280-2500	1,169	2,760	80
ACA-P2150-1500	839	1,749	150
ACA-P2150-2000	1,009	2,087	150
ACA-P2150-2500	1,174	2,419	150
ACA-P2220-1500	839	1,749	220
ACA-P2220-2000	1,009	2,259	220
ACA-P2220-2500	1,174	2,760	220



Balancer Kits for ACA-P2 Series Carbon Torque Smart Arms

Model	Min. Capacity KG	Max. Capacity KG
ACA-P2BK-4	2	4
ACA-P2BK-6	4	6
ACA-P2BK-8	6	8
ACA-P2BK-10	8	10
ACA-P2BK-14	10	14

Encoder Options for ACA-P2 Smart Arm

AcraDyne Gen IV Smart Arm System With Process Visualization

AcraDyne's Gen IV controller with smart arm capability and process visualization provides an advanced error-proofing solution to ensure the quality of your fastening operation. The capability is integrated into the Gen IV controller – no need for an external PC or software. See page 17 for more details.



FEATURES AND BENEFITS

- Easy to follow visual guidance directly on the Gen IV controller graphical screen
- Easy to program and set up
- Low cost solution vs. competitive offerings
- Modular – can be added at any time to an existing AcraDyne system using the Gen IV controller

ACA-POSIX Positioning System

The compact, self-contained ACA-Posix process visualization system guides operators through their assigned tasks. It connects to ACA-P2 series arms with integrated balancer kits.



FEATURES AND BENEFITS

- Intuitive and simple programming on 7" color LCD touch-screen display
- Store up to 500 unique assembly sequences
- Communicates directly with Power Tool controllers over digital I/O
- Store and display product images or CAD drawings. Images/drawings are displayed with targeting sequences to direct operators easily through their task
- Output for synchronizing with line controls

Carbon Torque Arms

TOOL HOLDERS FOR TELESCOPING CARBON ARMS

Tool Holders For AcraDyne Tools

Model	Description
ACAH-40PS1000	Tool holder for carbon fiber arm, AcraDyne 1000 series pistol/straight tools, 40 Nm
ACAH-80PS3-5000	Tool holder for carbon fiber arm, AcraDyne 3000/5000 series pistol/straight tools, 80 Nm
ACAH-150PS3-5000	Tool holder for carbon fiber arm, AcraDyne 3000/5000 series pistol/straight tools, 150 Nm



General Tool Holders

	Model	Description	Min. Tool Grip MM	Max. Tool Grip MM
For Telescopic Arms				
Base Tool Holders				
	ACAH-15	Base tool holder 4 screws	27	45
	ACAH-40-80	Base tool holder 4 screws	30	60
	ACAH-150-220	Base tool holder 4 screws	40	70
Multi-Position Tool Holders				
	ACAH-15-MPE2745	Multi-position tool holder interface	27	45
	ACAH-150220-MPE4070	Multi position tool holder	40	70
	ACAH-4080-MPE2745	Multi-position tool holder	27	45
Swivel Tool Holders				
	ACAH-S154080	Swivel tool holder 20 to 35 mm	20	35
	ACAH-SL15150	Swivel tool holder 40 to 55 mm	40	55



Carbon Torque Tubes

ACTT & ACPTT SERIES CARBON TORQUE TUBES



ACPTT Series
Anti-Rotation Torque Tube
with articulation support



ACTT Series
Anti-Rotation Torque Tube

Carbon Torque Tubes Are Universal Arms With an Exclusive Design For Maximum Tightening Flexibility

ACCT and ACPTT series carbon torque tubes provide smooth and accurate tool travel from bearing splined shaft construction. These sturdy arms are available in torque ranges of 15 – 80 Nm. They can be used with a variety of tool holders.

Tools recommended for use with this arm:

- Continuous Drive Electric and Pneumatic Tools
- Pulse Tools



ACTT-V40-850 300

ACTT Series Carbon Torque Tubes

Model	Min. Length Mm	Max. Length MM	Max Torque NM
ACTT-V15-600 150	150	600	15
ACTT-V15-800 300	300	800	15
ACTT-V40-600 150	150	600	40
ACTT-V40-850 300	300	850	40
ACTT-V40-1500 600	600	1,500	40
ACTT-V80-900 300	300	900	80
ACTT-V80-1500 600	600	1,500	80
ACTT-V80-2100 900	900	2,100	80

FEATURES AND BENEFITS

- Universal arm with an exclusive design for maximum tightening flexibility
- Provides articulated anti-rotation support when torque reaction is parallel to arm axis

Carbon Torque Tubes

ACPTT SERIES CARBON TORQUE TUBES FOR ACSA ARTICULATING SUPPORT ARMS

ACPTT TORQUE TUBES



FEATURES AND BENEFITS

- ACPTT arm designed for use with the ACSA articulating support arm
- ACPTT carbon torque tube provides articulated anti-rotation support when torque reaction is parallel to arm axis
- The ACPTT/ACSA articulating support arm system allows torque reaction arm installation when the workplace can't accommodate suspended overhead structures

ACPTT Torque Tubes

Model	Min. Length MM	Max. Length MM	Max Torque NM
ACPTT-V15-510 150	150	600	15
ACPTT-V15-710 300	300	800	15
ACPTT-V40-510 150	150	600	40
ACPTT-V40-760 300	300	850	40
ACPTT-V40-1410 600	600	1,500	40
ACPTT-V80-810 300	300	900	80
ACPTT-V80-1410 600	600	1,500	80



ACSA ARTICULATING SUPPORT ARM

ACSA Articulating Support Arms

Model	Max Reach MM	Max Height MM	Max Torque NM
ACSA-600-1500	600	1,500	80
ACSA-800-1500	800	1,500	80
ACSA-1000-1500	1,000	1,500	80

* Support arm, torque tube, balancer, tool holder, and tool shown for concept.

Items sold separately

ACAHTT Tool Holders For ACTT & ACPTT Anti-Rotation Carbon Arms

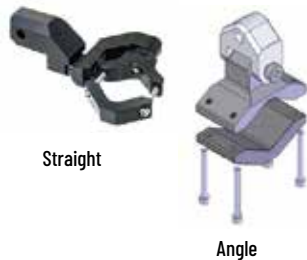

Model	Description	Min. Tool Grip MM	Max. Tool Grip MM
ACAHTT-15A-3060	Angle Tool Holder, 15 Nm Arm	30	60
ACAHTT-15S-2745	Straight Tool Holder, 15 Nm Arm	27	45
ACAHTT-4080A-3165	Angle Tool Holder, 40/80 Nm Arms	31	65
ACAHTT-40S-2745	Straight Tool Holder, 40/80 Nm Arms	27	45

GCI Torque Reaction Arms

GCI ARTICULATING TORQUE ARMS



Rugged Flexibility for Even the Most Complex Torque Applications

Constructed of durable aluminum, steel, or carbon fiber, GCI Torque Arms are available with multiple tool mounting options for application specifics. These highly ergonomic and user friendly arms are available in torque ranges of 150 Nm to 7,500 Nm and with reaches ranging up to 20 ft.

GCI arms can be designed as Smart Arms with two encoder options: PC-based AdaptiCS software (see page 15) and AcraDyne's Gen IV smart arm system with process visualization (see page 17). This complete Smart Arm system error-proofs even the most complex torque applications.

Tools recommended for use with this arm:

- AcraDyne 3000 - 9000 Series HT tools
- Angle (AEN 5000 series only)
- Straight (AES)
- Axial (AEJ)
- Pistol (AEP)
- Fixtured (AEF)

FEATURES AND BENEFITS

- Available in aluminum, steel, or carbon fiber
- Configurable installation: floor mount, wall mount, overhead mount, bench mount, or portable base
- Braking options: manual/automatic, discrete braking with verification, parking brakes, and electric/pneumatic actuation
- Tool holding options: fixed position, gimbal mount
- Integrated tool start/brake actuation capability: tool trigger start, remote tool start
- Smart Arm Capabilities:
 - Available with as many as six encoders to monitor all desirable tool positions relative to application
 - Two encoder options:
 - ▶ AcraDyne Gen IV Smart Arm System with Process Visualization (see page 17)
 - ▶ AdaptiCS PC-based software that runs on an integrated industrial PC or on a customer supplied PC (see page 15)

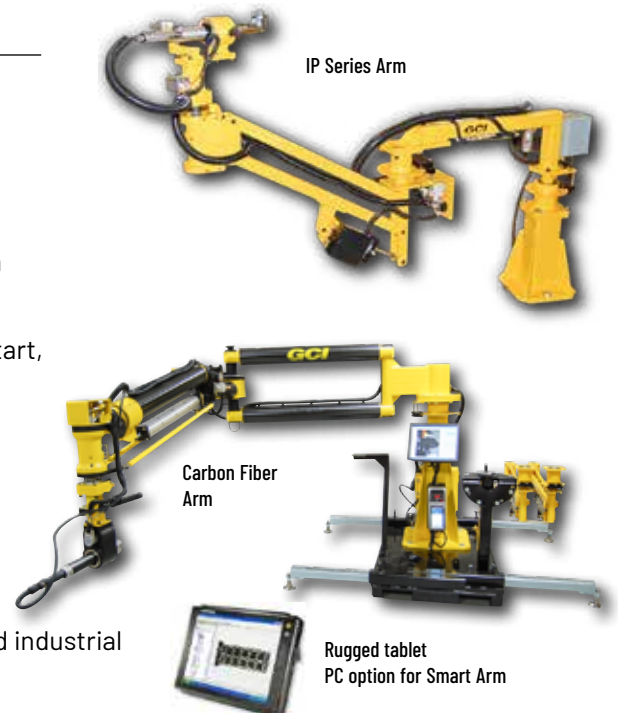

GCI Torque Reaction Arms

GCI Torque Reaction Arms

Model	Max. Torque	Max. Tool Weight	Max. Reach	Max. Vertical Travel	Construction
IPT Series - Torques to 375 Nm					
IPT150	150 Nm	12 lb	5 ft	30 in	Aluminum
IPT375	375 Nm	50 lb	6 ft	36 in	Steel
IP Series - Torques to 4,000 Nm					
IP4	550 Nm	30 lb	8 ft	48 in	Steel
IP5	1,000 Nm	50 lb	12 ft	60 in	Steel
IP7	3,000 Nm	100 lb	12 ft	60 in	Steel
IP8T	4,000 Nm	100 lb	12 ft	72 in	Steel
F Series - Carbon Fiber Arms					
F70	70 Nm	10 lb	3 ft	18 in	Carbon Fiber Composite
F600	600 Nm	50 lb	20 ft	72 in	Carbon Fiber Composite
F1500	1,500 Nm	50 lb	20 ft	72 in	Carbon Fiber Composite
F3000	3,000 Nm	75 lb	20 ft	72 in	Carbon Fiber Composite
F7500	7,500 Nm	75 lb	12 ft	72 in	Carbon Fiber Composite

GCI ARM OPTIONS



Additional Smart Arm Features

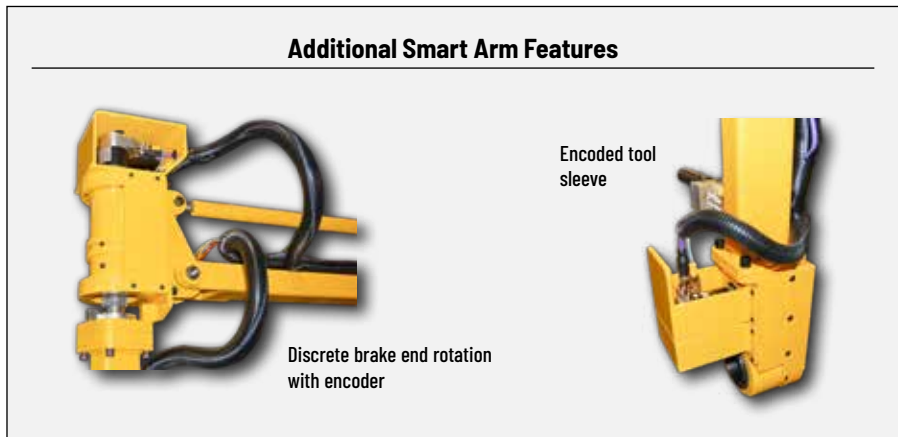

GCI Torque Reaction Arms

Encoder Options for GCI Smart Arms

AcraDyne Gen IV Smart Arm System with Process Visualization

AcraDyne's Gen IV controller with smart arm capability and process visualization provides an advanced error-proofing solution to ensure the quality of your fastening operation. The capability is integrated into the Gen IV controller – no need for an external PC or software. See page 17 for more details.

FEATURES AND BENEFITS

- Easy to follow visual guidance directly on the Gen IV controller graphical screen
- Easy to program and set up
- Low cost solution vs. competitive offerings
- Modular – can be added at any time to an existing AcraDyne system using the Gen IV controller



AdaptiCS Software

Intuitive, user-friendly AdaptiCS PC-based software that runs on an integrated industrial PC or on a customer supplied PC. Smart arms guide the operator in programmable torque patterns and count fasteners required for correct assembly.

FEATURES AND BENEFITS

- Batch count capabilities
- Bidirectional arm articulation tracking
- Full torque/angle results display
- Integrates into any line control (PLC, MES, etc.)
- Multiple part locate strategies (1-point, 2-point, 3-point)
- Multiple rework strategies to fit requirements
- Fully programmable dynamic display with integrated PC option
- Integrates devices such as torque controllers via open protocol, encoded GCI torque reaction arms, scanners, vision cameras, and digital IO (pass/fail)
- AdaptiCS Enterprise (optional) provides full line control, interlocks, and data collection
- Runs on Windows 7, 8, and 10



Gen IV Smart Arm System With Process Visualization

Gen IV Controller with On-Board Smart Arm Capability and Process Visualization

AcraDyne Gen IV Controller's smart arm capability provides an advanced error-proofing solution to ensure the quality of your fastening operation. The process requires no external PC or software – the capability is on-board every Gen IV controller.



FEATURES AND BENEFITS

- Easy-to-follow visual guidance on the Gen IV controller graphical screen
- Easy setup – programming takes only minutes
- Once fastener locations are programmed into the Gen IV controller, the system can perform specific actions on specific fasteners
- No external PC or third-party software needed. Control the process using AcraDyne's Gen IV Controller and its integrated software, which is provided free of charge
- Low-cost solution vs. competitive offerings that require third-party PC-based control
- Modular – can be added at any time to an existing AcraDyne system using the Gen IV controller
- No guesswork! Powerful Gen IV data collection enables diagnostics and analysis
- Works with both continuous and discontinuous drive tools

The Gen IV controller provides easy-to-follow visual guidance directly on the graphical screen.



Tool in position over Bolt 1

Bolt 1OK
Direction to Bolt 2

Tool in wrong location

Gen IV Smart Arm System With Process Visualization

Smart Arm Accessory:

- Requires no external PC or third-party software for operation
- Gen IV Controller Software integrates with plant manufacturing execution software or allows custom programming

Smart Arm guides operator in the specified torque pattern and counts fasteners required for correct assembly.

Encoders located at each joint of the arm.

Gen IV Controller captures fastening-process data:

- Data captured and reported in real time with torque and graphing capabilities
- Curve results presented in real time or from stored results
- 20,000 curve results can be stored in memory
- Monitor, control, and report torque, angle, engineering units, fastener count, job/job sequence
- Multiple fastening strategies: 256 parameter sets with 20 stages
- Jobs capabilities – 99



Smart Arm Accessory

Gen IV Controller with Large 7" Touch Screen

Custom image of run screen with preprogrammed fastener locations/specifications. Updates in real time.

Tool operates only when it is at the correct specified fastener location.

3arm Zero Gravity Arms

3arm ZERO GRAVITY ARMS



STRONG AND DEPENDABLE, 3ARM ERGONOMIC ARMS PROVIDE FULL RANGE OF MOTION TO COMPLETE ANY TASK EFFICIENTLY AND SAFELY

Designed to keep tools and devices weightless even in difficult positions and working areas, 3arms are available with more than 29 head configurations. Add in various available accessories, and the arms can be fixed in almost any position. More than 1,000 standard combinations are available, as well as customized solutions.



Tools recommended for use with this arm:

- Tools that have sufficient mass for counter balancing and where overhead suspension is not an option

FEATURES AND BENEFITS

- Eases use of larger, higher weight tools, eliminating the hazards of operators having to physically carry the loads.
- Durable closed-case design absorbs considerable force
- Eliminates tool weight, providing not only an ergonomic benefit, but also increasing productivity
- Reduces operator fatigue and the chance of injury due to strain
- Holds any tool up to 77 lbs, keeping the tool weightless, while eliminating possible damage caused by dropping the tool
- Can be base-mounted, ceiling-mounted, or wall-mounted. Easily add precision reach by applying a rail, make it mobile with a trolley, or adding vertical reach with a mounting column
- Available with tool trigger braking. Effortlessly position the tool, stop it in place, release trigger, and float it to the next job



3arm Zero Gravity Arms

3arm Series 1

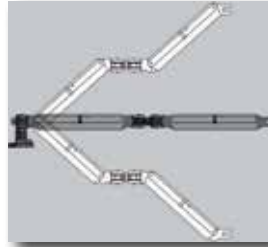

Light and nimble, capable of reaching even the most difficult applications.

Reach Vertical: 44 in Horizontal: 42 in	Max Weight 22 lb
--	----------------------------

Model	Orientation	Reach (IN)		Max Weight LB
		Vert.	Horiz.	
1SNIDS	Floor Mounted	42	44	22
1AMIDS	Ceiling Mounted	42	44	22

Compatible Head Members (22): B, BA, C, E, EA, F, G, K, N, T

Brake Options

L00	Not Required
-----	--------------

To build your 3arm, choose the following

Arm Model	Head Member	Brake Option

3arm Series 2

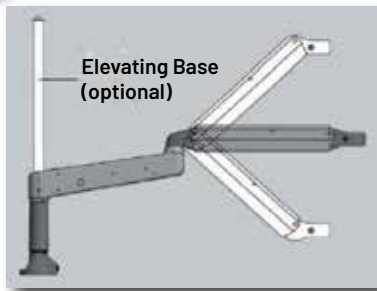

Combination radial arm and tilting arm, each capable of 360° rotation. Two arms of different lengths give you the ability to reach separate working areas.

Reach Vertical: 22 in Horizontal: 34 in	Max Weight 13 lb	Max Torque 120 Nm 88 ft-lb
--	----------------------------	---

Model	Orientation	Reach (IN)		Max Weight LB
		Vert.	Horiz.	
BB	Floor Mounted	22.2	33.9	13
BE	Ceiling Mounted	22.2	33.9	13
BA	Ceiling Mounted	22.2	33.9	13

Compatible Head Members (22): B, BA, C, E, EA, F, G, K, N

Brake Options

L00	Not Required
-----	--------------

To build your 3arm, choose the following

Arm Model	Head Member	Brake Option



3arm Zero Gravity Arms

3arm Series 3



Reach
Vertical: 42 in
Horizontal: 68 in

Max Weight
77 lb

Max Torque
650 Nm
479 ft-lb

Versatile arm with a long reach and the ability to carry a heavy load. Features “turning and tilting” brake locking systems (pneumatic or manual), allowing the operator to immobilize the arm in a fixed position on all axes simultaneously or separately.

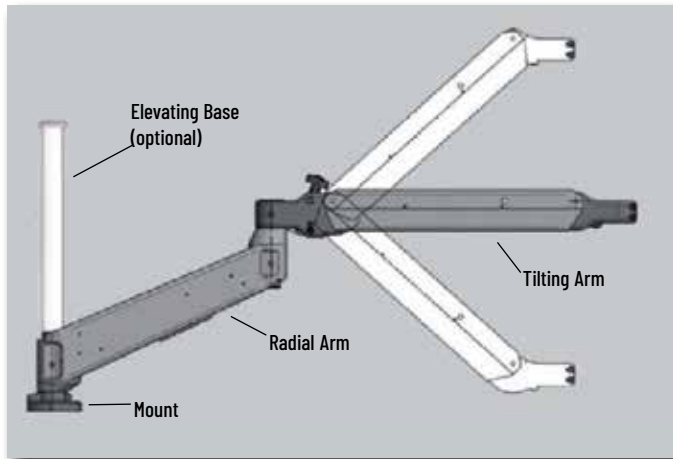

Model	Orientation	Reach (IN)		Max Weight LB
		Vert.	Horiz.	
Floor Mounted				
PSBS	Short Rad. + Short Tilt.	27.8	41.7	77
PSBM	Short Rad. + Long Tilt.	44.5	53.5	40
PLBS	Long Rad. + Short Tilt.	27.8	55.9	77
PLBM	Long Rad. + Long Tilt.	44.5	67.6	40
Ceiling Mounted				
PEBS	Short Rad. + Short Tilt.	27.8	41.7	77
PEBM	Short Rad. + Long Tilt.	44.5	53.5	40
ASBS	Long Rad. + Short Tilt.	27.8	55.9	77
ASBM	Long Rad. + Long Tilt.	44.5	67.6	40
Elevating Base				
ALBS	Elevating+ Short Tilt.	27.8	43.7	77
ALBM	Elevating+ Long Tilt.	44.5	55.8	40

Compatible Head Members (22): All

Brake Options

L00	Not Required
L11	Manual
L22	Pneumatic
L50	Manual Locking Base
L92	Tool Trigger Activated

To build your 3arm, choose the following

Arm Model	Head Member	Brake Option

3arm Zero Gravity Arms

3arm Series 4



Dual-tilting arms expand range of movement. The innovative connections between the parts of the arm allow completely free movement of rolling up, down, and sideways. Capable of reaching the most difficult positions or work with weightless precision.

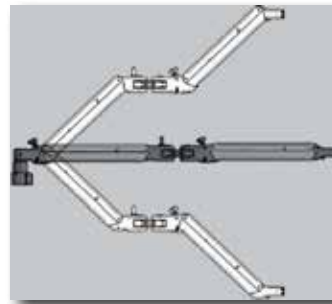

Reach
Vertical: 54 in
Horizontal: 58 in

Max Weight
53 lb

Max Torque
300 Nm
221 ft-lb

Model	Orientation	Reach (IN)		Max Weight LB
		Vert.	Horiz.	
DS	Floor Mounted, Short Arm	42.3	48	53
DM	Floor Mounted, Long Arm	55.5	57.5	43
ADS	Ceiling Mounted, Short Arm	42.3	48	53
ADM	Ceiling Mounted, Long Arm	55.5	57.5	43

Compatible Head Members (22): All

Brake Options

L00	Not Required
L11	Manual
L22	Pneumatic
L50	Manual Locking Base
L92	Tool Trigger Activated

To build your 3arm, choose the following

Arm Model	Head Member	Brake Option

3arm Series 6



Extendable arm with ball linear guideways attached to a pendulum base arm, both capable of 360° rotation. This compact arm offers versatility for any type of tool. The telescopic top arm allows the user to work on hard-to-reach areas comfortably, quickly and safely. Works in a wide variety of applications.

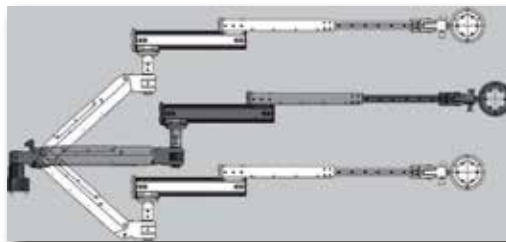

Reach
Vertical: 26 in
Horizontal: 82 in

Max Weight
42 lb

Model	Description	Reach (IN)		Max Weight LB
		Vert.	Horiz.	
BPRASC	Model 800	26	68	42
BPRASM	Model 1200	26	82	26

Compatible Head Members (22):
BPRASC - All
BPRASM - N,T

Brake Options

L00	Not Required
-----	--------------

To build your 3arm, choose the following

Arm Model	Head Member	Brake Option

3arm Zero Gravity Arms

3arm Head Members

Once you've determined the tools that will be used in you application, select a head member based on the type of application and necessary orientations.

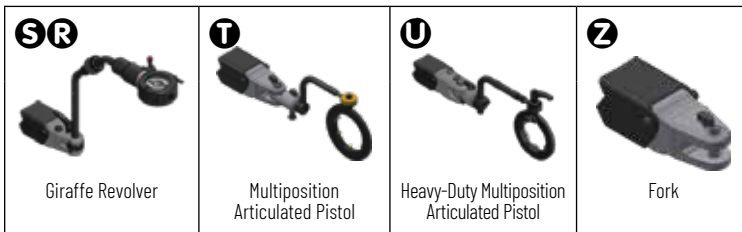
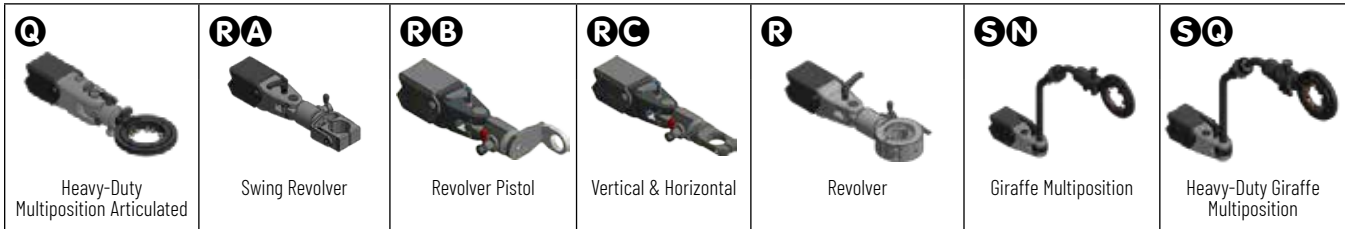
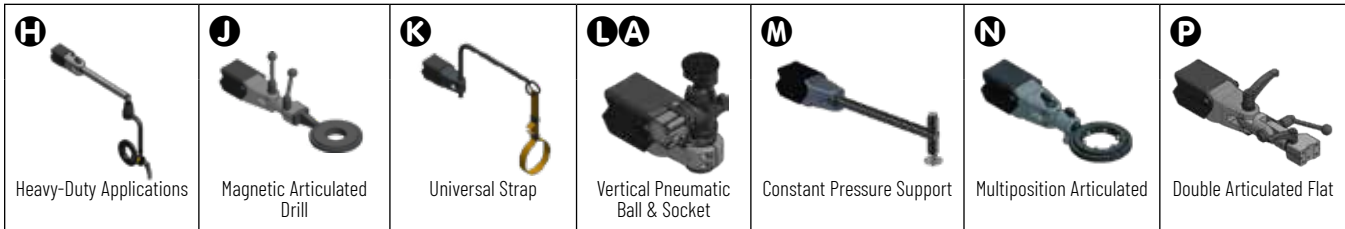
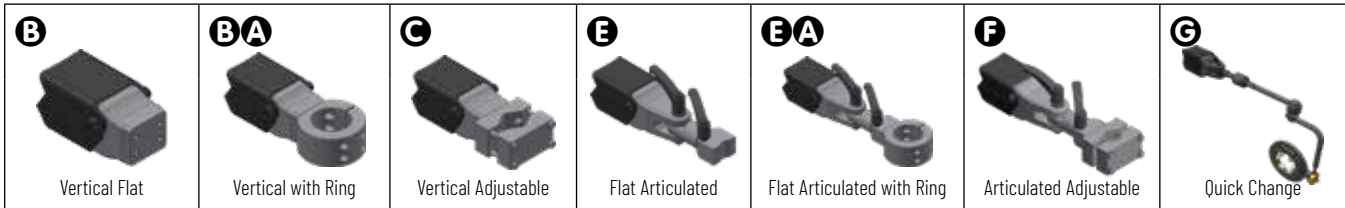

3arm Brake Options



L11
Manual Brakes
Manually turned handle



L22
Pneumatic Brakes

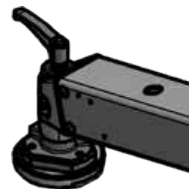

L50
Manual Locking Base
Handle at base only



L92
Tool Trigger Activated Brake
Pneumatic, activated through the tool

Support System Tool-Mounting Options

TOOL MOUNTING OPTIONS



AIMCO provides many head and mounting options to fit almost any application. Find more information in our Application Manual for Arms and Fixtures located on our website.

Contact an AIMCO Customer Service Associate for more details, 1-503-254-6600, or toll free 1-800-852-1368.

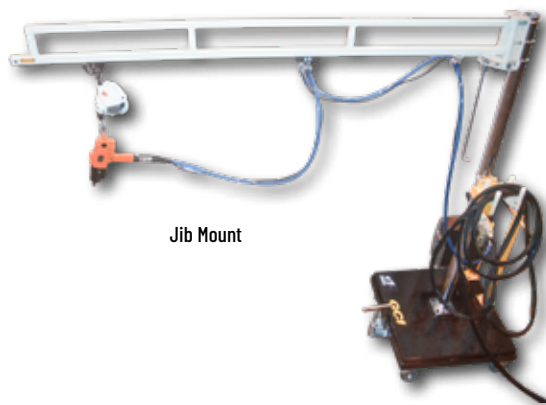
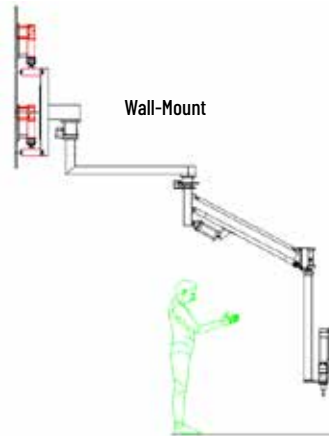

Workstation Components and Assemblies

COMPONENTS

TRACK

Steel with beige polyester finish. Use for vertical and horizontal workstation support.

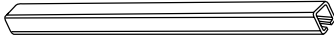

PART NUMBER	30# TRACK
AT3-3	3 ft track
AT3-4	4 ft track
AT3-6	6 ft track
AT3-9*	9 ft track

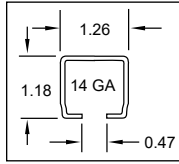

PART NUMBER	50# TRACK
AT5-3	3 ft track
AT5-4	4 ft track
AT5-6	6 ft track
AT5-9*	9 ft track
AT5-12*	12 ft track

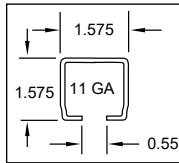

TRACK NUT (ATN-3/5)

Zinc plated steel. Use to attach accessories to track, as end stops, or to isolate rolling accessories.

- ATN-3 for 30 lb. track
- ATN-5 for 50 lb. track



END STOP (AES-3/5)

Zinc oxide finish. Use to prevent balancer trolley from "overtouring" horizontal track.

- AES-3 for 30 lb. track
- AES-5 for 50 lb. track

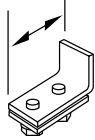

MOUNTING PLATE (AMP-5)

Black polyester finish. Use as a base to mount vertical uprights.

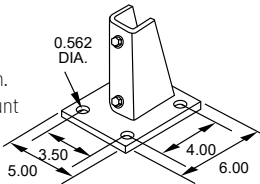

END CAP (AEP-3/5)

Black molded vinyl. Use to cap track ends for a professional finish.

- AEP-3 for 30 lb. track
- AEP-5 for 50 lb. track



ANGLE BRACKET (AB-3/5)

Black polyester finish. Use to mount horizontal track to vertical track.

- AB-3 for 30 lb. track
- AB-5 for 50 lb. track

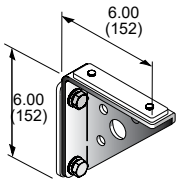

JOINT HANGER BRACKET (AJH-3/5)

Black polyester finish. Use to couple and hang end-to-end track.

- AJH-3 for 30 lb. track
- AJH-5 for 50 lb. track

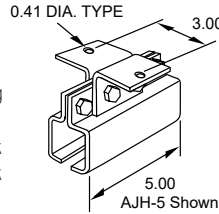

BALANCER TROLLEY (ABT-3/5)

Black polyester finish. Use as moving support for tool balancers, hose, and cable. Quality ball bearing wheels for long life and smooth tracking.

- ABT-3 for 30 lb track (1.00 dia)
- ABT-5 for 50 lb track (1.25 dia)

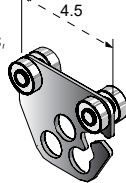

HANGER BRACKET (AHB-3/5)

Black polyester finish. Use to suspend track at right angle.

- AHB-3 for 30 lb. track
- AHB-5 for 50 lb. track

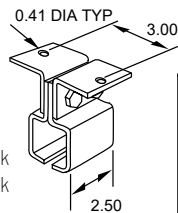

VERTICAL COLUMN (AVC-5*)

Beige polyester finish, 3" diameter x 9 ft upright steel column with welded base. Use as floor mount for extra stability with jibs or workstation components.



HOSE/CABLE TROLLEY

Black polyester finish. Use for moving cable or hose festoon. Supports hose cable OD .60-.94.

- AIC-2 for 50 lb. track

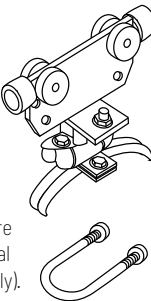

U-BOLTS (AUB-5)

Zinc plated steel. Use to secure boom bracket, or any flat metal plate, to AVC-5 (sold individually).

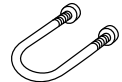

SUPPORT CLAMPS (ASC-3/5)

Black polyester finish. Use as additional support for track.

- ASC-3 for 30 lb. track
- ASC-5 for 50 lb. track

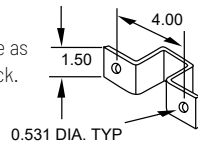

TOOL CLIP (SH-5)

Steel clip with safety latch. Use for tool attachment and as replacement clip for lightweight tool balancers. Measures 2.37" long.



90° CONNECTOR FOR 3/8" HOSE (WSCH)

3/8" I.D. Brass. Use to provide stable transfer point from air line to tool. 90 degree connector attaches to ABT-5.

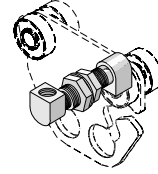

WALL- AND FLOOR- MOUNTED JIBS

3 FT. SWINGING JIB (AW3S)

3 FT FIXED JIB (AW3F)

3 FT. SWINGING JIB FOR CHANNEL MOUNT (AJS3**)

Jibs are mounted to wall or beams to create free standing workstations. End stop, end cap, and balancer trolley included. Maximum weight: 30 lb.

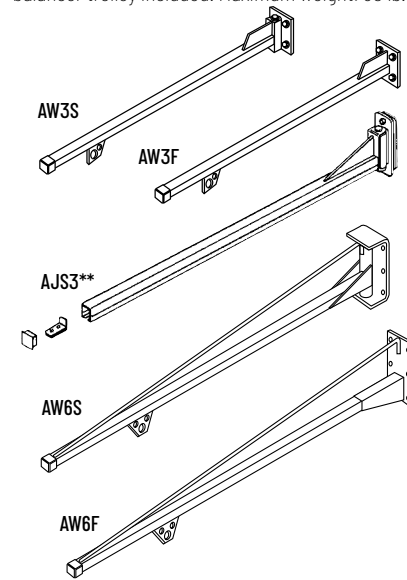

6 FT. SWINGING JIB (AW6S)

6 FT FIXED JIB (AW6F)

Jibs can be wall mounted or attached to vertical column (AVC-5) to create a freestanding workstation. End stop, end caps, and balancer trolley are included. Maximum weight: 50 lb.

All complete assemblies are beige polyester finish and include balancer trolley, end caps, and end stops. Floor mounted assemblies are not able to ship via UPS.

When choosing a workstation system, remember...

Total weight capacities should include tool balancer, hose/cable, and tool/fixture. Units need to be supported vertically and horizontally every 6 ft.

** Additional freight may apply

** AJS3 Does not include balancer trolley

Workstation Components and Assemblies

FLOOR MOUNTED 3 FT. FIXED JIB* (AW3FMF)

Maximum weight: 30 lb
Column height: 6 ft

FLOOR MOUNTED 6 FT. SWINGING JIB* (AW6FMS*)

FLOOR MOUNTED 6 FT. FIXED JIB* (AW6FMF*)

Maximum weight: 50 lb
Column height: 9 ft

*Units include end stop,
balancer trolley and intermediate carrier.

BENCH MOUNTED SWINGING JIB (JJ30-S) BENCH MOUNTED FIXED JIB (JJ30)

Maximum weight: 30 lb
Column height: 48" including mounting plate
3 ft. swinging jib includes balancer
trolley, end stop, and cap

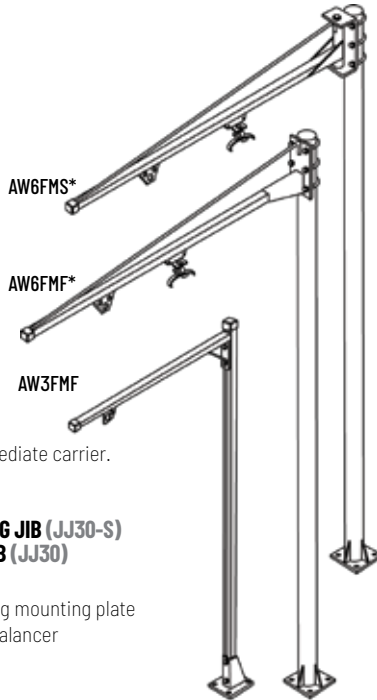
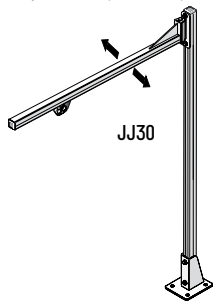

AIMCO WORKSTATION KIT

BENCH MOUNTED WORKSTATION WITH TORQUE ARM (JJ30-TA**)

- 5 lb. maximum weight (RPA-3 included)
- 5' column height including mounting plate
- 38" jib length (swinging)
- 15 ft-lb torque rating
- 3/8" NPT inlet
- 1/4" NPT outlet
- Beige polyester finish
- 1/4" braided air hose
- 21" maximum vertical arm travel

**Additional freight may apply
**For use with pneumatic tools only

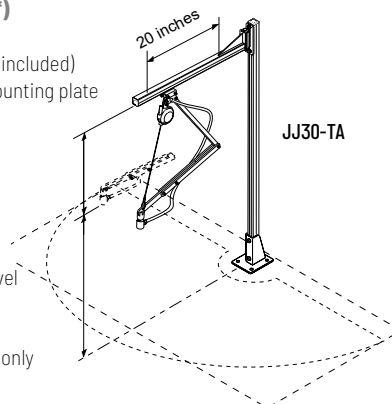

CREATE A CUSTOM SUPPORT SYSTEM USING AIMCO'S QUALITY PRODUCTS

- Organize work area to create a safe, productive working environment
- Reduce risk of injury to assembler by providing support for heavy tools
- Protect valuable tools, fixtures, and monitoring devices from damage by suspending them out of the way

AIMCO BASIC WORKSTATION KIT (ATW-50)



- 50 lb maximum weight capacity
- 48" uprights
- 36" extensions
- Table mounts included
- 6' tool rail with rolling trolley included
- All necessary hardware included

TROLLEY MOUNTED TORQUE ARM WITH 3-LB RETRACTOR AND HOSE (FA-50-2*)

Ergonomic arm absorbs torque reaction.
Moves front to back along overhead jib.

(TA-50-2)

Moves side to side on overhead track.

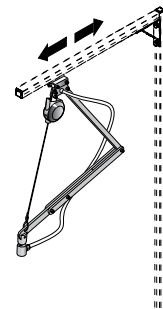

TOOL BASKET (21226)

Mounts easily to any work area to
hold pistol and angle style tools.

AIMCO can customize a workstation for you.

Contact an AIMCO Customer Service Associate 1-503-254-6600, or toll free 1-800-852-1368.

Gravity-Defying Balancers

TW SERIES BALANCERS



TW-0 and TW-00

- Gravity defying / "true balance"
- No tension buildup to cause worker fatigue
- Easy external direct drive tensioning
- 360° upper swivel
- Safety cable provision
- Tool clip included



TW-3 through TW-70

- Tapered drum allows "true balance" throughout cable travel
- Easy external direct drive tensioning
- Cast aluminum casing for durability
- Permanent lubrication
- 360° top swivel
- Enclosed spiral spring for added safety
- Safety chain provision (TW-3 through TW-15 models)
- Automatic safety lock plus manual drum lock (TW-22 through TW-70)

TW Series Balancers

Model	Capacity		Anti-Gravity Capacity (LB)	Cable
	LB	KG		
TW-00	1.1 - 3.3	0.5 - 1.5	2.5 - 3.0	18" stranded steel cable 1/8" dia.
TW-0	1.1 - 3.3	0.5 - 1.5	2.5 - 3.0	3.3-ft stranded steel cable 1/8" dia.
TW-3	2.2 - 6.6	1.0 - 3.0	4.5 - 6.0	4.3-ft stranded steel cable 5/32" dia.
TW-5	5.5 - 11.0	2.5 - 5.0	8.0 - 10.5	4.3-ft stranded steel cable 5/32" dia.
TW-9	9.9 - 19.8	4.5 - 9.0	15.0 - 19.0	4.3-ft stranded steel cable 5/32" dia.
TW-15	19.8 - 33.0	9.0 - 15.0	26.0 - 32.5	4.3-ft stranded steel cable 5/32" dia.
TW-22	33.0 - 48.4	15 - 22	41.0 - 48.0	5-ft stranded steel cable 3/16" dia.
TW-30	48.4 - 66.0	22 - 30	58.0 - 65.5	5-ft stranded steel cable 3/16" dia.
TW-40	66.0 - 88.0	30 - 40	77.5 - 87.5	5-ft stranded steel cable 3/16" dia.
TW-50	88.0 - 110.0	40 - 50	100.0 - 109.5	5-ft stranded steel cable 3/16" dia.
TW-60	110.0 - 132.0	50 - 60	122.0 - 131.0	5-ft stranded steel cable 3/16" dia.
TW-70	132.0 - 154.0	60 - 70	144.0 - 153.0	5-ft stranded steel cable 3/16" dia.

ASB SERIES BALANCERS

- Built-in Safety Features: The cable, drum, and enclosed spring are fully visible without opening the unit for easy and convenient safety checks. The sturdy spiral spring is enclosed for greater control and safety
- Ergonomic Spring Release: The automatic safety lock provides extra control
- Extended Cable Length: Stainless steel cables allow for extended reach on applications
- Enhanced Gear Mechanism: Allows for more exact adjustment of tension
- No Recoil and Low Resistance: Tapered drum style provides gravity defying tool positioning and low travel



ASB-0C Gravity Defying and Hand Adjustable Balancer



ASB-3C
ASB-5C

ASB Series Balancers

Model	Capacity		Stroke		Weight	
	lb	kg	in	cm	lb	kg
ASB-0C	1.1 - 3.3 lb	0.5 - 1.5 kg	51.1 in	130 cm	1.5 lb	0.7 kg
ASB-3C	3.3 - 6.6 lb	1.5 - 3 kg	86.4 in	220 cm	3.0 lb	1.4 kg
ASB-5C	5.5 - 11 lb	2.5 - 5 kg	86.4 in	220 cm	3.4 lb	1.5 kg

Line Reel Balancers / Retractors

LINE REEL BALANCERS

LR Series

- Designed for light duty applications with small pneumatic tools
- Integrating air hose and support cable keep work areas clean
- Adjustable ball stop for optional positioning
- 1/4" I.D. polyvinyl hose with 1/4" NPT inlet
- 360° upper swivel
- Maximum 142 PSI



LR Series Line Reel Balancers

Model	Hose Length		Capacity	
LR-09B-90	35.5 in	90 cm	3 lb	1.5 kg
LR-09B-200	78.3 in	199 cm	3 lb	1.5 kg

RETRACTORS

RPA Series

- No tools needed to set tension
- 5 ft nylon coated steel cable
- Reinforced hanging bracket includes safety cable provision
- Adjustable cable stop
- Three (3) models support weight 0.5 – 5 lb
- Tool clip included

RMA-L Series

- Steel housing with polyester finish
- Reinforced hanging bracket includes safety cable provision
- 8 ft of 3/32" diameter coated steel cable
- Permanently lubricated
- Tool clip included
- External tension adjustment
- Ratchet cable lock



RPA / RMA-L Series Retractors

Model	Capacity	
RPA-1	0.5 - 1.5 lb	0.2 - 0.7 kg
RPA-2	1.5 - 3.0 lb	0.7 - 1.4 kg
RPA-3	3.0 - 5.0 lb	1.4 - 2.3 kg
RMA-7L	5 - 10 lb*	2.3 - 4.8 kg*
RMA-15L	10 - 15 lb*	4.5 - 6.8 kg*
RMA-20L	15 - 23 lb*	6.8 - 10.4 kg*

* With ratchet lock

Air Preparation Units

AFRL STACKING FILTER/REGULATORS

Stacking filter/regulator combinations provide air filtration and precise regulation in a single unit for easy mounting and installation.

FEATURES AND BENEFITS

- All models include L-mount bracket, gauge, and metal bowl shields
- Polycarbonate filter and lubricator bowls (metal bowls standard on AFRL-8)
- 25-micron filter included on all models
- Regulating range: 7 - 125 PSI
- Custom order upgrade items include metal bowl, 5 micron filter, semi-automatic filter drain, and reduced PSI range regulator. Contact an AIMCO Customer Service Associate for more information, 1-503-254-6600, or toll free 1-800-852-1368
- Maximum allowable Input Pressure not to exceed 120 PSI



AFRL-2-C
AFRL-3-C

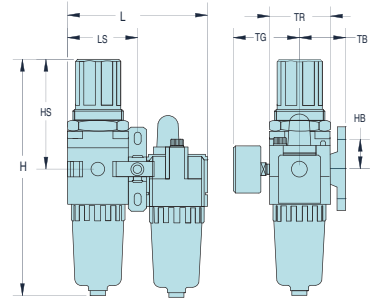

AFRL-3
AFRL-4
AFRL-8

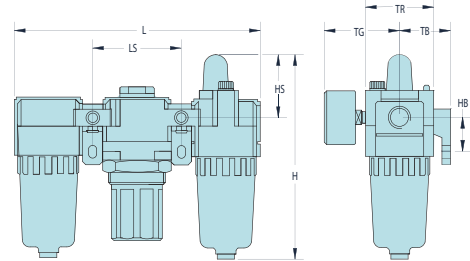

28178
HT Air Tool/AFRL
Carrying Kit



AFRL-4HTA
Standalone Unit

AFRL Stacking Filter/Regulators

Model	Port	Gauge Port	Flow Rate CFM	Flow Rate L/MIN	Bowl Shield	H IN/MM	HB IN/MM	HS IN/MM	L IN/MM	LS IN/MM	TB IN/MM	TG IN/MM	TR IN/MM
AFRL-2	1/4"	1/8"	70	2,000	yes	6.16 (156.5)	1.39 (35.3)	1.50 (38.1)	7.13 (181.1)	2.52 (64.0)	1.61 (41.0)	2.39 (60.7)	2.09 (53.1)
AFRL-2-C	1/4"	1/8"	60	1,700	yes	8.31 (211.1)	1.38 (35.1)	3.64 (92.5)	4.61 (117.1)	2.30 (58.4)	1.61 (40.9)	2.39 (60.7)	2.09 (53.1)
AFRL-3	3/8"	1/4"	140	4,000	yes	7.54 (191.5)	1.57 (40.0)	1.61 (40.9)	9.37 (238.0)	3.31 (84.1)	1.97 (50.0)	2.58 (65.5)	2.76 (70.1)
AFRL-3-C	3/8"	1/4"	105	3,000	yes	10.31 (261.9)	1.57 (39.9)	4.41 (112.0)	6.06 (153.9)	3.03 (77.0)	1.97 (50.0)	2.58 (65.5)	2.76 (70.1)
AFRL-4	1/2"	1/4"	140	4,000	yes	7.54 (191.5)	1.57 (40.0)	1.61 (40.9)	9.37 (238.0)	3.31 (84.1)	1.97 (50.0)	2.58 (65.5)	2.76 (70.1)
AFRL-8	1"	1/4"	180	5,000	yes	10.69 (271.5)	1.97 (50.0)	1.89 (48.0)	11.81 (300.0)	4.13 (104.9)	2.75 (69.9)	2.97 (75.4)	3.54 (89.9)

Air Preparation Units: Basic Functions

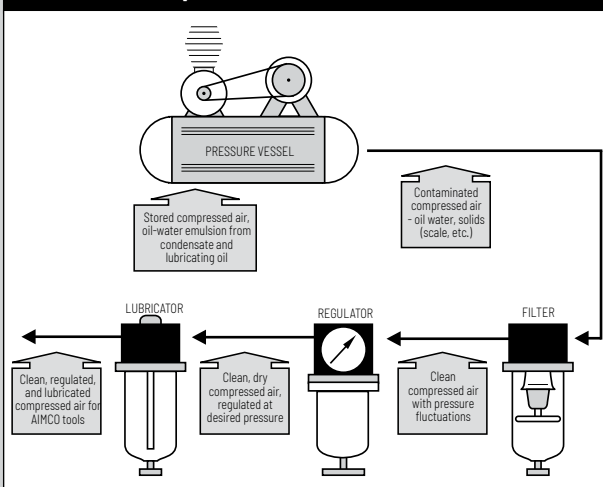

The supply of clean, dry air is essential to the operation of pneumatic powered tools. Use only clean filtered air for longer tool life. Provide proper airflow (CFM) and regulate air pressure (PSI) for optimum performance.

To determine unit size for application, you need to know:

- Total air flow (CFM) required for application
- Size of incoming air line and size of air line required by tool
- Air supply pressure (PSI)
- Allowable pressure drop
- Does the application require lubrication?
- Does the overall system have the required capacity?

Air Line

Polyurethane Hose



- Durable Polyurethane is chemical resistant and lightweight, and provides excellent recoil memory and maximum flexibility
- Available in transparent hose color (opaque also available)
- Assemblies for coiled hose include reusable swivel fitting. Straight hose available with or without fittings
- Working temperature: -104° F to 175° F

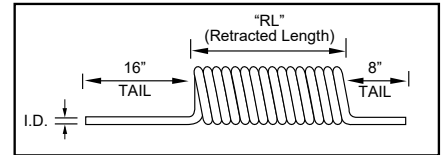

Single Air Hose Assemblies (Coiled)

Model	Description (O.D. x I.D. x Length)	Retracted Length	Working Pressure	Npt Fittings
ASH-250C-10MSZ	3/8" x 1/4" x 10'	7"	100 psi	1/4"
ASH-250C-15MSZ	3/8" x 1/4" x 15'	9-1/2"	100 psi	1/4"
ASH-250C-25MSZ	3/8" x 1/4" x 25'	15-1/2"	100 psi	1/4"
ASH-375C-15MSZ	9/16" x 3/8" x 15'	10"	100 psi	3/8"
ASH-375C-25MSZ	9/16" x 3/8" x 25'	14"	100 psi	3/8"
ASH-500C-15MSZ	3/4" x 1/2" x 15'	13"	100 psi	1/2"
ASH-500C-25MSZ	3/4" x 1/2" x 25'	23"	100 psi	1/2"

Custom length coil assemblies and special colors available in minimum order quantities. contact an AIMCO Customer Service Associate, 1-503-254-6600, or toll free 1-800-852-1368.



Straight Air Hose (Sold Per Foot)

Model	Description
ASH-375Z	3/8" I.D.
ASH-500Z	1/2" I.D.

Contact an AIMCO Customer Service Associate about full reel pricing, 1-503-254-6600, or toll free 1-800-852-1368.

Rubber Hose



- Designed for use in a wide range of industrial, construction, and agricultural applications
- Constructed of high grade, reinforced EPDM synthetic rubber
- Working temperature: -40° F to 190° F

Single Air Hose (Rubber)

I.D.	O.D.	Length	Working Pressure	Weight
3/16"	0.44"	10 ft	200 psi	0.8 lb
1/4"	0.5"	10 ft	200 psi	0.9 lb
5/16"	0.58"	10 ft	200 psi	1.2 lb
3/8"	0.67"	10 ft	200 psi	1.5 lb
1/2"	0.81"	10 ft	200 psi	2.0 lb
5/8"	0.97"	10 ft	200 psi	2.7 lb
3/4"	1.12"	10 ft	200 psi	3.4 lb

Custom lengths available. Contact an AIMCO Customer Service Associate for more details, 1-503-254-6600, or toll free 1-800-852-1368.

Helpful Hints For Air Hose Use

- Use recommended I.D. air hose and fittings
- Replace air hose regularly to help maintain clean air
- A clear hose allows you to see water or dirt accumulation in hose
- Use correct length of hose to reduce air loss and pressure drop
- Use locking quick-disconnect couplers for additional safety

Air Line Accessories

BRASS QUICK COUPLERS

Manual ball couplers designed for use with ergonomic twist plugs. Brass with nitrile seals, rated to 300 PSI, from -40° to +250° F.



Model	Description
B23	1/4" NPT F x 1/4" QC Brass Coupler
B23E	1/4" NPT F x 3/8" QC Brass Coupler
B25	3/8" NPT F x 3/8" QC Brass Coupler

IN-LINE MINI REGULATORS

Easily adjust airflow with the turn of a dial.



Model	Capacity
932-100-0	1/8" NPT
932-110-0A	1/4" NPT

MINI AIR GAUGE SWIVEL JOINT KITS

- Bi-directional 360° rotation
- Keeps air hose straight and untwisted
- Decreases operator fatigue



Model	Inlet	Weight	Max Psi	Tool CFM
7021AG	1/4" NPT	3 oz	Up to 125	25
7041AG	3/8" NPT	3 oz	Up to 125	50



7021AG

SWIVEL AIR FITTINGS

For use with most portable air tools, including grinders, drills, screwdrivers, buffers, sanders, staple guns, and more. Rotates 360° for awkward angles.

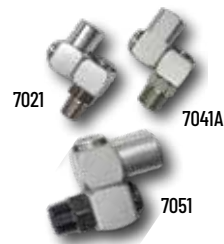

Model	Inlet	Weight	Max PSI	Tool CFM
7021	1/4" NPT	3 oz	Up to 125	25
7041A	3/8" NPT	11 oz	Up to 125	50
7051	1/2" NPT	7 oz	Up to 125	60

AIR LINE FITTINGS

Model	Capacity
250-RZ	1/4" NPT Rigid Fitting
250-SZ	1/4" NPT Swivel Fitting
375-RZ	3/8" NPT Rigid Fitting
375-SZ	3/8" NPT Swivel Fitting
500-SZ	1/2" NPT Swivel Fitting



BRASS ADAPTERS AND BUSHINGS

Pipe fittings for use as medium and low pressure connectors. Meets functional requirements of SAE J530, SAE J531, ASME and ASA. Rated 1,000 PSI from -65° to +250° F.



Model	Description
222P-6-4	3/8" NPT F x 1/4" NPT M Adapter
222P-8-6	1/2" NPT F x 3/8" NPT M Adapter
222P-12-8	3/4" NPT F x 1/2" NPT M Adapter
209P-6-4	1/4" NPT F x 3/8" NPT M Bushing
209P-8-6	3/8" NPT F x 1/2" NPT M Bushing

ERGONOMIC TWIST PLUGS

These unique, ergonomically designed hose fittings provide 360° rotation and 35° angled rotation in any direction.

- Two rotation points prevent kinking of air hose
- Design ensures full air pressure flow
- Rotating joint comes with polyurethane dust cover
- Heavy duty construction

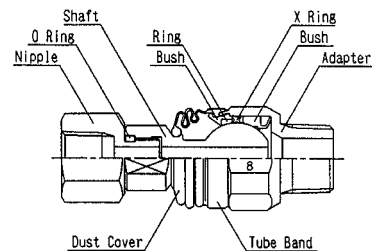

Model	Description
TS-30NP-2NPT	3/8" NPT Female x 1/4" NPT Male
TS-20NP-2NPT	1/4" NPT Female x 1/4" NPT Male
TS-20US-2NPT	1/4" US Plug x 1/4" NPT Male
TS-30US-3NPT	3/8" US Plug x 3/8" NPT Male

Index

MODEL #	PAGE	MODEL #	PAGE	MODEL #	PAGE	MODEL #	PAGE	MODEL #	PAGE
A		ACA-P280-2000	9	AFA10-550	6	AW6FMF	25	S	
AB-3	24	ACA-P280-2500	9	AFA15-400	6	AW6FMS	25	SH-5	24
AB-3/5	24	ACA-P2150-1500	9	AFRL-2	28	AW6S	24	T	
AB-5	24	ACA-P2150-2000	9	AFRL-2-C	28	B		TA-50-2	25
ABMJ 1200-600	7	ACA-P2150-2500	9	AFRL-3	28	B23	30	TS-20NP-2NPT	30
ABMJ 1200-1000	7	ACA-P2220-1500	9	AFRL-3-C	28	B23E	30	TS-20US-2NPT	30
ABMJ 2000-1000	7	ACA-P2220-2000	9	AFRL-8	28	B25	30	TS-30NP-2NPT	30
ABT-3	24	ACA-P2220-2500	9	AHB-3	24	BA Series 3arm	19	TS-30US-3NPT	30
ABT-5	24	ACA-V15-1000	8	AHB-5	24	BB Series 3arm	19	TW-00	26
ACA10-1000	8	ACA-V15-1500	8	AIC5-2	24	BE Series 3arm	19	TW-0	26
ACA10-1500	8	ACA-V15-2000	8	AJH-3	24	BPRASC Series 3arm	21	TW-3	26
ACA15-1000	8	ACA-V40-1000	8	AJH-5	24	BPRASM Series 3arm	21	TW-5	26
ACA15-1500	8	ACA-V40-1500	8	AJS3	24	D		TW-9	26
ACA15-2000	8	ACA-V40-2000	8	ALA5-200	6	DM Series 3arm	21	TW-15	26
ACA40-1000	8	ACA-V40-2500	8	ALA10-400	6	DS Series 3arm	21	TW-22	26
ACA40-1500	8	ACA-V80-1500	8	ALA15-200	6	F		TW-30	26
ACA40-2000	8	ACA-V80-2000	8	ALA40-300	6	F70	14	TW-40	26
ACA40-2500	8	ACA-V80-2500	8	ALA200-400	6	F600	14	TW-50	26
ACA80-1500	8	ACA-V150-1500	8	ALA400-400	6	F1500	14	TW-60	26
ACA80-2000	8	ACA-V150-2000	8	ALB Series 3arm	20	F3000	14	TW-70	26
ACA80-2500	8	ACA-V220-1500	8	ALBS Series 3arm	20	F7500	14	W	
ACA150-1500	8	ACA-V220-2000	8	AMP-5	24	FA-50-2	25	WSCH	24
ACA150-2000	8	ACA-V220-2500	8	ASB-0C	26	G		Numbers	
ACA150-2500	8	ACPTT-V15-510 150	12	ASB-3C	26	Gen IV Smart Arm System with Process Visualization	16	1AM1DS Series 3arm	19
ACA220-1500	8	ACPTT-V15-710 300	12	ASB-5C	26	I		15N1DS Series 3arm	19
ACA220-2000	8	ACPTT-V40-510 150	12	ASBM Series 3arm	20	IP4	14	209P-6-4	30
ACA220-2500	8	ACPTT-V40-760 300	12	ASBS Series 3arm	20	IP5	14	209P-8-6	30
ACAH-15	10	ACPTT-V40-1410 600	12	ASC-3	24	IP7	14	222P-6-4	30
ACAH-15-MPE2745	10	ACPTT-V40-1410 600	12	ASC-5	24	IP8T	14	222P-8-6	30
ACAH-40-80	10	ACPTT-V80-810 300	12	ASH-250C-10MSZ	29	IPT150	14	222P-12-8	30
ACAH-40PS1000	10	ACPTT-V80-1410 600	12	ASH-250C-15MSZ	29	IPT375	14	250-RZ	30
ACAH-80PS3-5000	10	ACSA-600-1500	12	ASH-250C-25MSZ	29	J		250-SZ	30
ACAH-150-220	10	ACSA-800-1500	12	ASH-375C-15MSZ	29	JJ30	25	21226	25
ACAH-150PS3-5000	10	ACSA-1000-1500	12	ASH-375C-25MSZ	29	JJ30-S	25	28178	28
ACAH-150PS3-5000	10	ACTT-V15-600 150	11	ASH-375Z	29	JJ30-TA	25	28796	29
ACAH-4080-MPE2745	10	ACTT-V15-800 300	11	ASH-500C-15MSZ	29	L		375-RZ	30
ACAH-150220-MPE4070	10	ACTT-V40-600 150	11	ASH-500C-25MSZ	29	LR-09B-90	27	375-SZ	30
ACAH-SL15150	10	ACTT-V40-850 300	11	ASH-500Z	29	LR-09B-200	27	500-SZ	30
ACAHTT-15A-3060	12	ACTT-V40-1500 600	11	AT3-3	24	P		7021	30
ACAHTT-15S-2745	12	ACTT-V80-900 300	11	AT3-4	24	PEBM Series 3arm	20	7021AG	30
ACAHTT-40S-2745	12	ACTT-V80-1500 600	11	AT3-6	24	PEBS Series 3arm	20	7021AG	30
ACAHTT-4080A-3165	12	ACTT-V80-2100 900	11	AT3-9	24	PLBM Series 3arm	20	7041A	30
ACA-P2BK-4	9	AD-D1098-P	5	AT5-3	24	PLBS Series 3arm	20	7041AG	30
ACA-P2BK-6	9	AD-D1098-PAC	5	AT5-4	24	PSBM Series 3arm	20	7051	30
ACA-P2BK-8	9	AD-D1098-PACE	5	AT5-6	24	PSBS Series 3arm	20	932-100-0	30
ACA-P2BK-10	9	AD-D1098-S	5	AT5-9	24	R		932-110-0A	30
ACA-P2BK-14	9	AD-D1098-SAC	5	AT5-12	24	RMA-7L	27		
ACA-P215-1000	9	ADM Series 3arm	21	ATN-3	24	RMA-15L	27		
ACA-P215-1500	9	ADS Series 3arm	21	ATN-5	24	RMA-20L	27		
ACA-P215-2000	9	AEP-3	24	ATW-50	25	RPA-1	27		
ACA-P240-1000	9	AEP-5	24	AUB-5	24	RPA-2	27		
ACA-P240-1500	9	AES-3	24	AVC-5	24	RPA-3	27		
ACA-P240-2000	9	AES-5	24	AW3F	24				
ACA-P240-2500	9	AFRL-4	28	AW3FMF	25				
ACA-P280-1500	9	AFRL-4HTA	28	AW3S	24				
		AFAS-400	6	AW6F	24				



PRINTED IN THE U.S.A.

LIT-AT120, REV 01-24-22, ©2022 AIMCO

AIMCO CORPORATE HEADQUARTERS

10000 SE Pine Street
Portland, Oregon 97216
Phone: (503) 254-6600
Toll Free: 1-800-852-1368

AIMCO CORPORATION DE MEXICO SA DE CV

Ave. Cristobal Colon 14529
Chihuahua, Chihuahua. 31125
Phone: (01-614) 380-1010
Fax: (01-614) 380-1019