



# POWER TOOLS *2022*



For more than 50 years, AIMCO has been working with manufacturers around the world. We are the complete global source for all critical fastening and bolting solutions. AIMCO can effectively and swiftly meet your needs whether you're in Tennessee, USA fastening a 3 mm nut at 3 Nm, or in Denmark servicing wind-turbine bolts at 17,000 Nm. AIMCO provides the tools and solutions, on a global scale, that guarantee the success of your project. It is with great pride that AIMCO can say the products that we manufacture are **MADE IN THE USA.**

# TABLE OF CONTENTS

## POWER TOOLS

AcraDyne HT Series Pneumatic Tools . . . . .	4
Omega Pulse: UAT Series . . . . .	7
Omega Pulse: UL / ULT Series . . . . .	9
Acra-Pulse® U / UX / UXR Series . . . . .	11
UTM Series Fastening Counter . . . . .	12
BP-T Pulse Series Cordless Tools . . . . .	13
UBX-T Series Cordless Pulse Tools . . . . .	15
UAN & URW Series Nutrunners . . . . .	17
TubeNut and Geared Wrenches . . . . .	18
DynaTorque® Manual Torque Multipliers . . . . .	19
US-LT / US / US-LD Pneumatic Screwdrivers . . . . .	20
Signature Series® Shut-Off Impact Cordless Tools . . . . .	24
Signature Series® Precision Clutch Cordless Tools . . . . .	25
Electra® Series Electric Screwdrivers . . . . .	27
Impact Tools . . . . .	30
Grinders . . . . .	32
Sanders & Drills . . . . .	33
Percussion Tools . . . . .	34
Air Preparation Units . . . . .	35
Air Line & Accessories . . . . .	36
<b>Index</b> . . . . .	<b>38</b>



\* **E** logo indicates where ERGO-DRIVE sockets/extensions benefit tool operation.

ERGO-DRIVE sockets are uniquely designed for repeatable, accurate rundowns. They also ensure excellent product quality, longer tool life, and better ergonomics for the tool user. Look for the ERGO-DRIVE **E** logo in this catalog to see where ERGO-DRIVE sockets/extensions benefit tool operation, operator, and rundown.

# AcraDyne High Torque Pneumatic Tools

## FEATURES AND BENEFITS

AcraDyne's High Torque Pneumatic Bolting Tools offer a reliable and dependable solution for the installation and removal of heavy-duty fasteners. Appropriate for use in industries requiring high torque capability, accuracy, power, and safety.

- Modular design allows for ease of maintenance
- Interchangeable motors and gearing
- Same proven and reliable gearbox as the AcraDyne DC line
- One-hand reverse



AAP1B66600A



AAP1B76950A



AAP1B772000A



AAP1B885100A



## AAPIB Series Tools

Model	Torque (NM)	Torque (FT-LB)	Speed (RPM)	Weight (LB)	Square Dr. (IN)	Air Consumption (CFM)
AAP1B66400A	400	300	57	9.75	3/4	22.9
AAP1B66600A	600	450	39	9.75	3/4	22.9
AAP1B66850A	850	625	27	9.75	3/4	22.9
AAP1B76950A	950	700	31	10.4	3/4	26.3
AAP1B771350A	1,350	1,000	22	10.4	1	26.3
AAP1B772000A	2,000	1,475	14	12.7	1	26.3
AAP1B772950A	2,950	2,175	9	14.9	1	26.3
AAP1B885100A	5,100	3,775	8	23	1-1/2	31.5

## AIR PREPARATION UNITS

Many stacking filter/regulator combinations are available. See page 35 for options.



AFRL-4



AFRL-4HTA Standalone Unit

28178 HT Air Tool/AFRL Carrying Kit



Maximum allowable Input Pressure not to exceed 120 PSI.

# AcraDyne High Torque, High Speed Pneumatic Tools

Our High-Torque, High-Speed Pneumatic Bolting Tools offer a reliable and dependable solution for the installation and removal of heavy-duty fasteners with high torque capability, accuracy, power, and safety.

## FEATURES AND BENEFITS

- Dual motor design provides extremely fast rundown speed
- Improved torque to weight ratio
- Full swivel gearcase facilitates reaction bar positioning for ease of use and operator comfort
- Handle exhaust with low sound level
- Uses the same durable and reliable gearbox from our DC line of high torque tools
- Modular design allows for easy maintenance
- Two-piece handle construction enables flexible handle design
- Available in reversible and non-reversible models



## AAP2B Series Tools

Model	Torque		Speed (RPM)	Weight		Length		Square Dr. (IN)
	(NM)	(FT-LB)		(LB)	(KG)	(IN)	(MM)	
AAP2B76250A	250	185	660	10.5	4.8	10	255	3/4
AAP2B76450A	450	330	335	10.5	4.8	10	255	3/4
AAP2B76650A	650	480	223	10.5	4.8	10	255	3/4
AAP2B76950A	950	700	153	10.5	4.8	10	255	3/4
AAP2B771400A	1,400	1,000	110	14.6	6.6	10	255	1
AAP2B772000A	2,000	1,475	63	14.8	6.7	11.2	284	1
AAP2B773000A	3,000	2,210	52	15.0	6.8	11.6	293	1
AAP2B785100A	4,800	3,540	26.5	19.7	8.9	13.3	338	1.5

## AAP2B Series Reversible Tools

Reversible Model	Torque		Speed (RPM)	Weight		Length		Square Dr. (IN)
	(NM)	(FT-LB)		(LB)	(KG)	(IN)	(MM)	
AAP2B76250AR	250	185	660	12.3	5.6	12.5	317	3/4
AAP2B76450AR	450	330	335	12.3	5.6	12.5	317	3/4
AAP2B76650AR	650	480	223	12.3	5.6	12.5	317	3/4
AAP2B76950AR	950	700	153	12.3	5.6	12.5	317	3/4
AAP2B771400AR	1,400	1,000	110	16.4	7.4	12.6	319	1
AAP2B772000AR	2,000	1,475	63	16.6	7.5	13.6	346	1
AAP2B773000AR	3,000	2,210	52	16.8	7.6	14.0	356	1
AAP2B785100AR	4,800	3,540	26.5	21.5	9.7	15.8	400	1.5

# AcraDyne HT Pneumatic Tool Accessories

## Polyurethane Hose for HT Tools



ASH-500C-15MSZ

- Durable Polyurethane is chemical resistant and lightweight, and provides excellent recoil memory and maximum flexibility
- Available in transparent hose color (opaque also available)
- Assemblies for coiled hose include reusable swivel fitting. Straight hose available with or without fittings
- Working temperature: -104° F to 175° F
- Working pressure: 100 PSI

### Single Air Hose Assemblies (Coiled)

Model	Description (O.D. x I.D. x Length)	Retracted Length	Npt Fittings
ASH-500C-15MSZ	3/4" x 1/2" x 15'	13"	1/2"
ASH-500C-25MSZ	3/4" x 1/2" x 25'	23"	1/2"

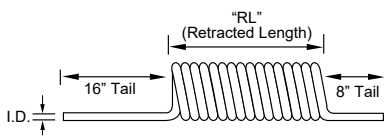

Custom length coil assemblies and special colors available in minimum order quantities. Contact an AIMCO Customer Service Associate, 1-503-254-6600, or toll free 1-800-852-1368.



### Straight Air Hose (Sold Per Foot)

MODEL	DESCRIPTION
ASH-500Z	1/2" I.D.

Contact an AIMCO Customer Service Associate about full reel pricing, 1-503-254-6600, or toll free 1-800-852-1368.

## Rubber Hose for HT Tools



28796  
1/2" ID

- Designed for use in a wide range of industrial, construction, and agricultural applications
- Constructed of high grade, reinforced EPDM synthetic rubber
- Working temperature: -40° F to 190° F

### Single Air Hose (Rubber)

I.D.	O.D.	Length	Working Pressure	Weight
1/2"	0.81"	10 ft	200 psi	2.0 lb
5/8"	0.97"	10 ft	200 psi	2.7 lb
3/4"	1.12"	10 ft	200 psi	3.4 lb

Custom lengths available. Contact an AIMCO Customer Service Associate for more details, 1-503-254-6600, or toll free 1-800-852-1368.

## REACTION BARS

Tool includes standard, spline attachment reaction device. Custom reaction devices are available; contact an AIMCO Customer Service Associate for more details, 1-503-254-6600, or toll free 1-800-852-1368.



Reaction Bars

## Air Line Fittings



### Plugs

Model	Description
28161	1/2" x 1/4" MPT
28162	1/2" x 3/8" MPT
28163	1/2" x 1/2" MPT
28164	1/2" x 1/2" FPT

### Quick-Change Couplers

Model	Description
27768	1/2" FPT
27769	1/2" MPT



### Protective Coupler

Model	Description
27771	Vinyl



### Swivel Fitting

Model	Capacity
500-SZ	1/2" NPT Swivel Fitting

# Omega Pulse Tools: UAT Series

## PATENTED AUTO RELIEF TECHNOLOGY:

UAT features patented Auto Relief Technology providing additional control to the application of torque during the pulsing events.

- Auto Relief eliminates initial spike of torque during a cycle. Highly effective on hard joint applications
- Auto Relief ramps up pressure within the pulse unit resulting in more pulses in less time providing a more efficient and even torque event

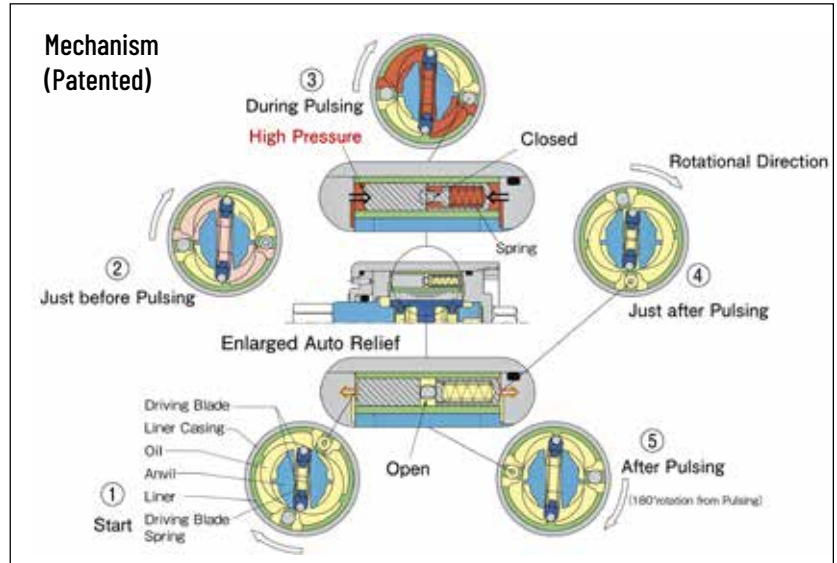

## A NEW LEAP FORWARD IN PRODUCTIVITY AND QUALITY:

- Fastening accuracy and time can be improved by as much as 30% depending on application

### Fastening efficiency comparison (UAT vs ULT)

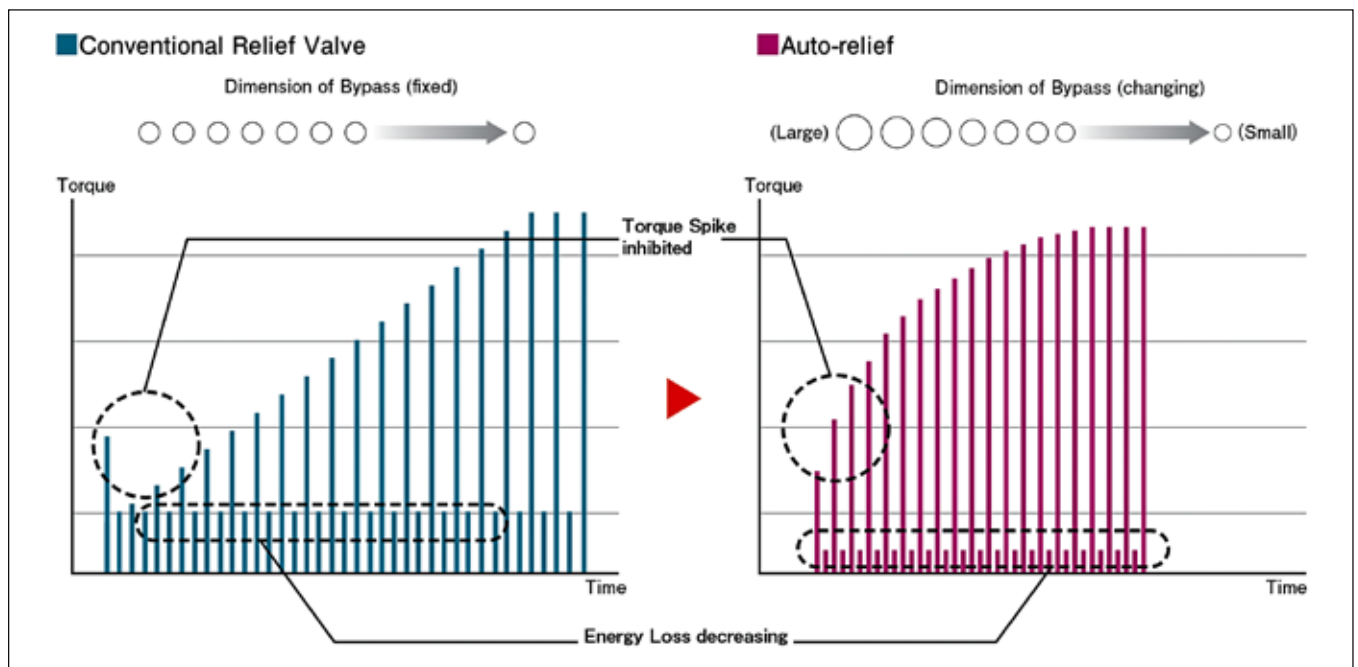
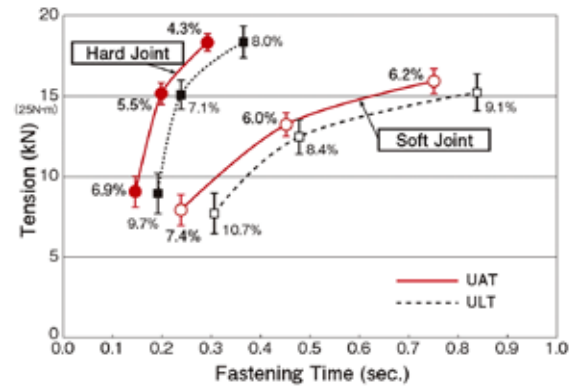

# Omega Pulse Tools: UAT Series



## UAT Series Pistol Shut-Off Tools

Recommended Air Pressure: 85 psi

Model	Free Speed RPM	Torque Range		Weight		Overall Length		Drive IN	Sound Level dB(A)	Air Usage CFM
		NM	FT-LB	LB	KG	IN	MM			
UAT-30D	4,200	2.5 - 5.5	1.9 - 4.1	1.9	0.9	6.5	165	1/4	76	10.5
UAT-40	3,800	4.5 - 8	3.3 - 5.9	2.0	0.9	6.4	162	3/8	75	8.8
UAT-40D	3,800	4.5 - 8	3.3 - 5.9	2.0	0.9	6.5	165	1/4	75	8.8
UAT-50	4,600	7 - 15.5	5.2 - 11.5	2.0	0.9	6.4	162	3/8	78	8.8
UAT-50D	4,600	7 - 15.5	5.2 - 11.5	2.0	0.9	6.5	165	1/4	78	8.8
UAT-50L	4,000	7 - 15.5	5.2 - 11.5	2.0	0.9	6.4	162	3/8	75	8.8
UAT-50DL	4,000	7 - 15.5	5.2 - 11.5	2.0	0.9	6.5	165	1/4	75	8.8
UAT-60	6,700	15 - 32	11.1 - 23.7	2.1	1.0	6.8	174	3/8	80	12.3
UAT-60D	6,700	15 - 32	11.1 - 23.7	2.1	1.0	7.0	177	1/4	80	12.3
UAT-60L	6,000	13 - 28	9.6 - 20.7	2.1	1.0	6.8	174	3/8	77	8.8
UAT-70	6,000	30 - 55	22.2 - 40.7	2.3	1.1	7.1	180	3/8	80	14.0
UAT-70L	5,300	25 - 48	18.5 - 35.5	2.3	1.1	7.1	180	3/8	78	10.5
UAT-80	5,600	45 - 63	33.3 - 46.6	2.8	1.3	7.3	186	3/8	80	16.8
UAT-90	5,700	50 - 85	37.0 - 62.9	3.2	1.5	7.6	192	1/2	82	18.6
UAT-90L	5,100	45 - 75	33.3 - 55.5	3.2	1.5	7.6	192	1/2	79	15.8
UAT-100	5,200	70 - 130	51.8 - 96.2	3.7	1.7	7.8	199	1/2	82	19.3
UAT-100L	5,200	60 - 110	44.4 - 81.4	3.7	1.7	7.8	199	1/2	79	16.8
UAT-130	4,500	110 - 150	81.4 - 111	5.1	2.3	8.5	217	1/2	82	24.6
UAT-150	3,900	140 - 210	103.6 - 155.4	6.4	2.9	9.5	240	3/4	82	24.6
UAT-180	3,300	160 - 250	118.4 - 185	8.1	3.7	10.5	264	3/4	84	24.6
UAT-200	2,400	200 - 400	148 - 296	12.8	5.8	11.0	279	3/4	85	35.2
UAT-200L	2,400	170 - 280	125.8 - 207.2	12.8	5.8	11.0	279	3/4	85	24.6



Air Hose Size: 1/4" ID for UAT-30D to UAT-50, 3/8" ID for UAT-60 to UAT-100, 1/2" ID for UAT-100L to UAT-200L Air Inlet Thread: 1/4" NPT for UAT-30D to UAT-150, 3/8" NPT for UAT-180 to UAT-200L

Note Torque Ranges reflect residual B joint torque values

UAT Models containing "L" indicate models designed to run at 57 PSI air pressure.

UAT Models containing "D" indicate 1/4" quick change bit holder

Most models can be equipped with TM (Tightening Monitor) feature for use with qualifier systems. Order TM tools by adding "TM" to model number (for example, UAT-60 becomes UAT-60TM).



## UAT Series Inline Shut-Off Tools

Recommended Air Pressure: 85 psi

Model	Free Speed RPM	Torque Range		Weight		Overall Length		Drive IN	Sound Level dB(A)	Air Usage CFM
		NM	FT-LB	LB	KG	IN	MM			
UAT-30SD	3,400	2.5 - 5.5	1.9 - 4.1	1.9	0.8	8.7	222	1/4	68	12.3
UAT-40S	3,300	4.5 - 8.0	3.3 - 5.9	1.9	0.9	8.8	224	3/8	70	7.0
UAT-40SD	3,300	4.5 - 8.0	3.3 - 5.9	1.9	0.9	8.9	227	1/4	70	7.0
UAT-50S	3,900	7.0 - 15.5	5.2 - 11.5	1.9	0.9	8.8	224	3/8	78	8.8
UAT-50SD	3,900	7.0 - 15.5	5.2 - 11.5	1.9	0.9	8.9	227	1/4	78	8.8
UAT-50SL	3,800	7.0 - 15.5	5.2 - 11.5	1.9	0.9	8.8	224	3/8	75	7.0
UAT-50SDL	3,800	7.0 - 15.5	5.2 - 11.5	1.9	0.9	8.9	227	1/4	75	7.0
UAT-60S	5,700	15.0 - 32.0	11.1 - 23.7	1.9	0.9	9.0	229	3/8	80	10.5
UAT-60SD	5,700	15.0 - 32.0	11.1 - 23.7	1.9	0.9	9.1	232	1/4	80	10.5
UAT-60SL	5,300	13.0 - 28.0	9.6 - 20.7	1.9	0.9	9.0	229	3/8	77	8.8
UAT-60SDL	5,300	13.0 - 28.0	9.6 - 20.7	1.9	0.9	9.1	232	1/4	77	8.8
UAT-70S	4,700	30.0 - 50.0	22.2 - 37.0	2.1	1.0	9.4	239	3/8	80	12.3
UAT-70SL	4,400	25.0 - 45.0	18.5 - 33.3	2.1	1.0	9.4	239	3/8	78	9.5

Air Hose Size: 1/4" ID for UAT-30 to UAT-50, 3/8" ID for UAT-60 to UAT-70

Air Inlet Thread: 1/4" NPT

Note Torque Ranges reflect residual B joint torque values

UAT Models containing "D" indicate 1/4" quick change bit holder

UAT Models containing "L" indicate models designed to run at 57 PSI air pressure.

Most models can be equipped with TM (Tightening Monitor) feature for use with qualifier systems. Order TM tools by adding "TM" to model number (for example, UAT-60 becomes UAT-60TM).

\*  logo indicates where ERGO-DRIVE sockets/extensions benefit tool operation.



# Omega Pulse Tools: UL Series

## OMEGA UL SERIES

Whether the goal is improving productivity, ergonomics, reliability, or quality, the UL Series contains the technology to achieve success.

### FEATURES AND BENEFITS

- Models available from 6 - 230 Nm (4.4 - 170 Ft-lb)
- Available in Standard, Tightening Monitor, and Transducerized versions
- High power-to-weight ratio
- Reduced maintenance and extended service life
- Environmentally friendly design
- Accurate and repeatable



UL-30  
UL-50



UL-60  
UL-70



UL-40

UL-80

UL-90

UL-100

UL-130

UL-150

Omega Series Pulse Unit

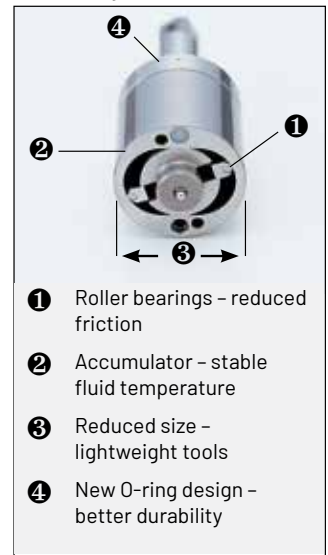

### UL Series Pistol Non Shut-Off Tools

Recommended Air Pressure: 85 psi

Model	Free Speed	Torque Range		Weight		Overall Length		Drive	Sound Level	Air Usage
	RPM	NM	FT-LB	LB	KG	IN	MM			
UL-30D	5,700	6 - 12	4.4 - 8.9	1.5	0.7	5.4	137	1/4 hex	75	7.0
UL-30	5,700	6 - 12	4.4 - 8.9	1.5	0.7	5.2	133	3/8 sq.	75	7.0
UL-40D	6,100	11 - 20	8.1 - 14.8	1.5	0.7	5.4	137	1/4 hex	75	7.0
UL-40	6,100	13 - 22	9.6 - 16.3	1.5	0.7	5.2	133	3/8 sq.	75	7.0
UL-50D	6,400	18 - 28	13.3 - 20.7	1.7	0.8	5.8	146	1/4 hex	78	10.5
UL-50	6,400	22 - 35	16.3 - 25.9	1.7	0.8	5.5	140	3/8 sq.	78	10.5
UL-60D	7,000	22 - 35	16.3 - 25.9	1.8	0.8	5.6	143	1/4 sq.	80	14.0
UL-60	7,000	32 - 50	23.7 - 37.0	1.8	0.8	5.5	140	3/8 sq.	80	14.0
UL-70	5,700	40 - 65	29.6 - 48.1	2.1	1.0	6.0	153	3/8 sq.	80	15.8
UL-80	5,900	45 - 70	33.3 - 50.0	2.5	1.1	6.4	162	3/8 sq.	80	16.8
UL-90	6,000	60 - 100	44.4 - 74.0	2.9	1.3	6.7	170	1/2 sq.	82	18.6
UL-100	5,400	80 - 130	59.2 - 96.2	3.7	1.7	7.0	177	1/2 sq.	80	20.3
UL-130	4,400	100 - 160	74.0 - 118.4	5.1	2.3	7.8	197	1/2 sq.	83	22.7
UL-150	3,800	150 - 230	109.9 - 169.6	6.6	3.0	8.4	213	3/4 sq.	84	24.7



UL-30S

UL-40S

UL-50S

UL-60S

UL-70S

### UL Series Inline Non Shut-Off Tools

Recommended Air Pressure: 85 psi

Model	Free Speed	Torque Range		Weight		Overall Length		Drive	Sound Level	Air Usage
	RPM	NM	FT-LB	LB	KG	IN	MM			
UL-30SD	5,000	6 - 12	4.4 - 8.9	1.4	0.6	8.2	209	1/4 hex	75	8.1
UL-30S	5,000	6 - 12	4.4 - 8.9	1.4	0.6	8.1	205	3/8 sq.	72	8.1
UL-40SD	5,000	9 - 20	6.7 - 14.8	1.4	0.6	8.2	209	1/4 hex	75	8.1
UL-40S	5,000	11 - 22	8.1 - 16.3	1.4	0.6	8.1	205	3/8 sq.	72	8.1
UL-50SD	6,400	18 - 28	13.3 - 20.7	1.6	0.7	8.4	214	1/4 hex	78	12.3
UL-50S	6,400	22 - 35	16.3 - 25.9	1.6	0.7	8.2	208	3/8 sq.	78	12.3
UL-60SD	6,700	22 - 35	16.3 - 25.9	1.7	0.8	8.3	212	1/4 hex	80	15.8
UL-60S	6,700	32 - 50	23.7 - 37.0	1.7	0.8	8.2	209	3/8 sq.	80	15.8
UL-70S	5,400	36 - 60	26.6 - 44.4	1.9	0.9	8.8	223	3/8 sq.	84	14.0

Air Hose Size: 1/4 I.D. for UL-30 (D/SD) - UL-50 (D/SD) - 3/8" I.D. for UL-60 (D/SD) - UL-150 (D/SD)  
All pulse tools ending in "D" include a 1/4" Hex quick-change bit holder.

Air Inlet: N.P.T. 1/4"

NOTE: Torque ranges reflect residual B joint torque values

\*  logo indicates where ERGO-DRIVE sockets/extensions benefit tool operation.

Visit our website [www.aimco-global.com](http://www.aimco-global.com)

# Omega Pulse: ULT Series

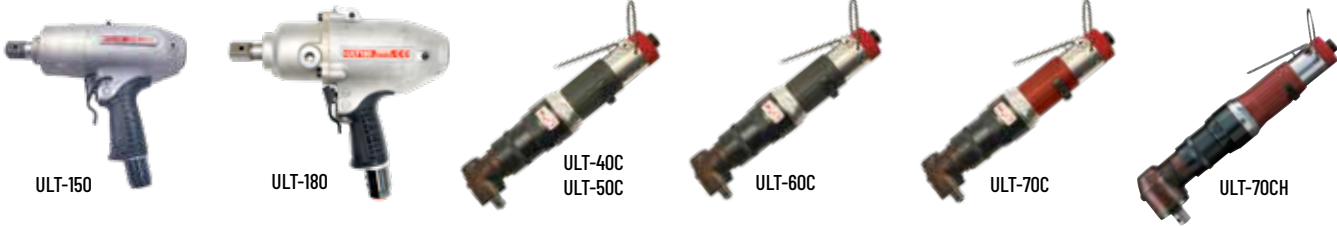

## ULT Series Pistol / Angle Shut-Off Tools **E**

Recommended Air Pressure: 85 psi

Model	Free Speed RPM	Torque Range NM FT-LB		Weight LB KG		Overall Length IN MM		Drive IN	Sound Level dB(A)	Air Usage CFM
<b>Pistol</b>										
ULT-150	3,700	140 - 210	104 - 155	6.4	2.9	9.5	240	3/4" Sq. Dr.	82	24.7
ULT-180	3,300	160 - 250	118 - 185	8.1	3.7	10.4	264	3/4" Sq. Dr.	82	24.7
<b>Angle</b>										
ULT-40C	3,500	4.5 - 7.5	3.3 - 5.6	2.9	1.30	9.8	250	3/8" Sq. Dr.	70	7.0
ULT-50C	4,500	7.0 - 15.5	5.2 - 11.5	3.0	1.35	9.8	250	3/8" Sq. Dr.	78	8.6
ULT-60C	5,200	13 - 28	9.6 - 20.7	3.2	1.45	10.3	261	3/8" Sq. Dr.	80	10.5
ULT-70C	4,400	20 - 35	14.8 - 25.9	3.6	1.65	10.8	275	3/8" Sq. Dr.	82	12.3
ULT-70CH	2,500	30 - 50	22.2 - 37.0	4.1	1.85	11.4	290	1/2" Sq. Dr.	82	12.3

"L" following model number denotes Low Air Pressure type  
 "H" within model number denotes High Torque type

NOTE: Torque ranges reflect residual B joint torque values



\* **E** logo indicates where ERGO-DRIVE sockets/extensions benefit tool operation.

# Acra-Pulse Series



U-350D



UXR-2000



UX-ST800

## Acra-Pulse Pistol Tools

Recommended Air Pressure: 85 psi

Model	Free Speed RPM	Torque Range*		Overall Length		Weight		From Center To Outside		Drive SIZE	Noise Level dB(A)	Air Hose I.D.	Air Inlet N.P.T.	Air Usage CFM
		NM	FT-LB	MM	IN	LB	KG	MM	IN					
Non Shut-Off, 1/4" Hex Dr. 1/4" Quick Change Chuck Standard											Air Hose Size: 1/4" I.D.	Air Inlet: N.P.T. 1/4"		
U-350D	10,500	3.5 - 5.8	2.5 - 4.2	154	6.1	1.7	0.8	22.0	0.9	1/4" Hex	74	1/4"	1/4"	5.3
Non Shut-Off, 3/4" Sq. Dr. Torque Control in Right-Hand Rotation Standard Left-Hand Rotation also available for UXR-2000											Air Hose Size: 1/2" I.D.	Air Inlet: N.P.T. 3/8"		
UXR-2000	4,200	300 - 450	220 - 330	282	11.1	14.3	6.5	47.0	1.8	3/4" Sq. Dr.	85	1/2"	3/8"	31.5
Non Shut-Off, 3/8" Sq. Dr. Auto Reversing Stud Bolt Wrench											Air Hose Size: 3/8" I.D.	Air Inlet: N.P.T. 1/4"		
UX-ST800	7,300	35 - 55	25 - 40	195	7.7	3.8	1.8	28.0	1.1	3/8" Sq. Dr.	75	3/8"	1/2"	10.5

\* NOTE: Torque range reflects residual B joint torque values



U-310SD



U-350SD



UX-900S  
UX-1000S



UX-1300S



UXR-2000S  
UXR-2400S



UXR-3000S



UXR-T2400S  
UXR-T3000S

## Acra-Pulse Inline Tools

Recommended Air Pressure: 85 psi

Model	Free Speed RPM	Torque Range*		Overall Length		Weight		From Center To Outside		Drive SIZE	Noise Level dB(A)	Air Hose I.D.	Air Inlet NPT	Air Usage CFM
		NM	FT-LB	MM	IN	LB	KG	MM	IN					
Non Shut-Off, 1/4" Hex Dr. 1/4" Quick Change Chuck Standard														
U-310SD	11,000	2.5 - 3.1	1.8 - 2.2	222	8.7	1.5	0.6	18.0	0.7	1/4" Hex	74	1/4"	1/4"	5.3
U-350SD	10,500	3.5 - 5.8	2.5 - 4.2	238	9.4	1.5	0.7	22.0	0.7	1/4" Hex	74	1/4"	1/4"	5.3
Non Shut-Off, 1/2" Sq. Dr.														
UX-900S	7,600	45 - 75	35 - 55	310	12.2	3.9	1.8	37.5	1.1	1/2" Sq. Dr.	75	3/8"	1/4"	14.9
UX-1000S	6,800	50 - 95	40 - 70	320	12.6	4.6	2.1	39.0	1.1	1/2" Sq. Dr.	75	3/8"	1/4"	17.9
UX-1300S	6,200	80 - 130	60 - 95	336	13.2	6.6	2.6	42.0	1.3	1/2" Sq. Dr.	77	3/8"	1/4"	19.4
Non Shut-Off, 3/4" Drive TM = Models equipped with a tightening monitor feature for use with qualifier systems														
UXR-2000S(TM)	4,200	300 - 450	220 - 330	340	13.4	15.4	7.0	47.0	1.8	3/4" Sq. Dr.	85	1/2"	3/8"	31.6
Non Shut-Off, 1" Sq. Dr. TM = Models equipped with a tightening monitor feature for use with qualifier systems														
UXR-2400S(TM)	4,000	400 - 650	290 - 470	385	15.2	23.7	11.0	55.0	2.1	1" Sq. Dr.	85	1/2"	1/2"	35.2
UXR-3000S(TM)	4,400	500 - 850	360 - 630	455	17.9	29.3	13.3	62.0	2.1	1" Sq. Dr.	85	1/2"	1/2"	37.1
Shut-Off, 1" Sq. Dr. Inside Trigger Standard TM = Models equipped with a tightening monitor feature for use with qualifier systems														
UXR-T2400S(TM)	3,600	360 - 650	260 - 470	444	17.5	26.5	12.0	61.5	2.4	1" Sq. Dr.	85	1/2"	1/2"	35.3
UXR-T3000S(TM)	4,400	450 - 850	330 - 620	477	18.8	32.0	14.5	62.0	2.4	1" Sq. Dr.	85	1/2"	1/2"	37.1

\* NOTE: Torque range reflects residual B joint torque values



UX-500C



UX-612C



UX-700C



UX-800C



UX-1000C

## Acra-Pulse Angle Tools

Recommended Air Pressure: 85 psi

Model	Free Speed RPM	Torque Range*		Weight		Overall Length		Drive SIZE	Noise Level dB(A)	Air Hose I.D.	Air Inlet N.P.T.	Air Usage CFM
		NM	FT-LB	LB	KG	MM	IN					
Non Shut-Off, 3/8" Sq. Dr.												
UX-500C	9,300	13 - 20	10.0 - 15.0	2.8	1.3	270	10.6	3/8" Sq. Dr.	82	1/4"	1/4"	8.8
UX-612C	9,800	16 - 28	12.0 - 20.0	3.0	1.4	283	11.1	3/8" Sq. Dr.	85	3/8"	1/4"	11.2
UX-700C	9,500	20 - 36	16.0 - 28.0	3.7	1.7	273	10.8	3/8" Sq. Dr.	85	3/8"	1/4"	12.3
UX-800C	9,000	29 - 43	20.0 - 31.0	4.3	1.9	285	11.2	3/8" Sq. Dr.	85	3/8"	1/4"	14.1
Non Shut-Off, 1/2" Sq. Dr.												
UX-1000C	6,800	50 - 80	40.0 - 58.0	6.8	3.1	365	14.4	1/2" Sq. Dr.	90	3/8"	1/4"	17.9

\*NOTE: Torque ranges reflect residual B joint torque values

\*  logo indicates where ERGO-DRIVE sockets/extensions benefit tool operation.

# UTM Series Fastening Counter

## Flexible Poka-Yoke for Quality and Line Control

The UTM-1500 Fastening Counter helps you verify that your assembly procedures are being followed. Parameter setup is simple and can be programmed at the front panel or via a PC. The UTM-1500 provides audible and visual Accept/Reject indications on all rundowns, ensuring that all your fastening is secure.



### FEATURES AND BENEFITS

- For use with tools that have the TM feature installed, including AIMCO pulse tools, AIMCO angle nutrunners, AIMCO clutch screwdrivers, and all pistol or lever-start screwdrivers
- Automatically set up pressure values
- Communication and line control:
  - PLC communication inputs (5)/outputs (8)
  - Remote parameter switch selection
  - Variable relays for interfacing with process equipment
  - Optional network interfaces available
- Qualification of "good cycle"



### PROCESS VERIFICATION

- Four selectable parameters
- Cycle counting and batch counting
- Programmable timers for detection of double hits, cross-threads, or premature trigger release

### A COMPLETE TURNKEY SYSTEM INCLUDES:

- New or retrofitted TM tool
  - Retrofit most existing AIMCO tools for under \$200. Contact an AIMCO Customer Service Associate, 1-503-254-6600, or toll free 1-800-852-1368.
  - Order TM tools by adding "TM" to model number. (Example: UAT-70 becomes UAT-70TM)
- UTM-1500 Fastening Counter
- Digital Pressure Switch (878-845-1)
- 5 m Sensor Cable (910-831-0) or 10 m Sensor Cable (910-832-0)

### UTM Series Fastener Counters

Model	Voltage & Frequency	Operational Ambient Temperature	Operational Ambient Humidity	Dimensions	Weight	
					LB	KG
UTM-1500A	115 V / 50 Hz	0 - 50° C (non-freezing)	90% RH or less (no dew)	200 mm x 210 mm x 100 mm 7.9" x 8.3" x 3.9"	4.5	2.0
UTM-1500E	230 V / 60 Hz	0 - 50° C (non-freezing)	90% RH or less (no dew)	200 mm x 210 mm x 100 mm 7.9" x 8.3" x 3.9"	4.5	2.0

# BP-T Pulse Series Cordless Tools

“Operator First” design means a lighter-weight, ergonomic pulse tool

## FEATURES AND BENEFITS

- Direct Power Train and High-Efficiency Brushless Electric Motor deliver reduced noise and vibration
- Hydraulic Impulse Unit delivers reaction-free tightening
- Cooling fan improves heat management, increasing duty cycle up to 20% over the UDBP-TA series
- High-capacity Li-Ion battery pack provides up to 20% more fastener runs per charge than the UDBP-TA series
- The Ergonomic Handle coupled with a Compact Design provides an improved user experience
- Available in regular and wireless transmitting versions (RF8). RF8 models communicate with a receiver for Line Control interfacing



## BP-T Series Tools

Model*	Capacity (Nominal Bolt Size)		Torque Range		Free Speed	Overall Length		Weight W/O Socket Bit				From Center To Outside		Sq. Dr Or Hex Size		Sound Level dB(A)	Battery Voltage (Capacity)
	MM	IN	NM	FT-LB		MM	IN	KG	LB	KG	LB	MM	IN	MM	IN		
BP-T40-(B)(KIT)	5	No. 10	4.5-8	3.3-5.9	3,300	197	7.8	1.4	3.08	1.15	2.53	27	1.1	9.5 Hex	3/8 Sq.	75	10.8V (2.0Ah)
BP-T40D-(B)(KIT)	5	No. 10	4.5-8	3.3-5.9	3,300	200	7.9	1.4	3.08	1.15	2.53	27	1.1	6.35 Hex	1/4 Hex	75	10.8V (2.0Ah)
BP-T50-(B)(KIT)	6-8	1/4-5/16	7-15	5.1-11.1	3,900	197	7.8	1.4	3.08	1.15	2.53	27	1.1	9.5 Sq.	3/8 Sq.	76	10.8V (2.0Ah)
BP-T50D-(B)(KIT)	6-8	1/4-5/16	6.5-13	4.8-9.6	3,900	200	7.9	1.4	3.08	1.15	2.53	27	1.1	6.35 Hex	1/4 Hex	76	10.8V (2.0Ah)
BP-T60-(B)(KIT)	8	5/16	13-26	9.6-19.2	4,800	202	8.0	1.6	3.52	1.25	2.75	27	1.1	9.5 Sq.	3/8 Sq.	76	14.4V (2.0Ah)
BP-T60D-(B)(KIT)	8	5/16	13-26	9.6-19.2	4,800	205	8.1	1.6	3.52	1.25	2.75	27	1.1	6.35 Hex	1/4 Hex	77	14.4V (2.0Ah)

\* Base models come with no battery. Batteries are available separately or in tool/kit combinations.

Add "B" to end of the model number to order 1 tool with 1 battery.

Add "KIT" to the end of the model number to order a tool kit, which includes 1 tool, 2 batteries, and 1 battery charger.

\* **E** logo indicates where ERGO-DRIVE sockets/extensions benefit tool operation.

# BP-T Pulse Series Cordless Tools

BP-T series tools with the RF8 option enable wireless communication upon successful shut-off of the tool when fastening. This feature can be used to send the shut-off signal when used with the TW-800R receiver (required). The receiver can be tied to a PLC or the optional UTM-1500 Fastener Counter for collecting fastening counts.

## RF8 : Poka-Yoke Configuration

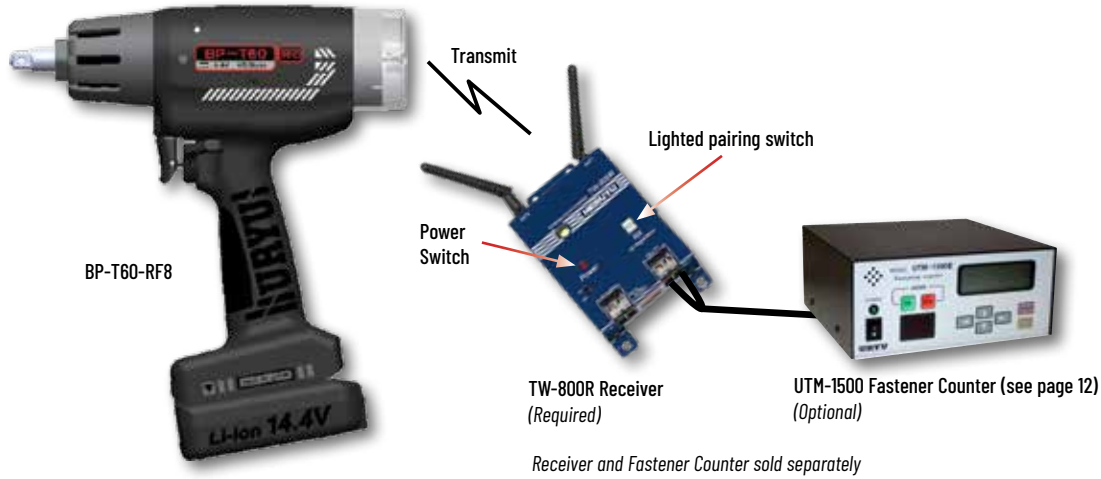

## BP-T RF8 Series Tools

Model*	Capacity (Nominal Bolt Size)		Torque Range		Free Speed	Overall Length		Weight W/O Socket Bit				From Center To Outside		Sq. Dr Or Hex Size		Sound Level dB(A)	Battery Voltage (Capacity)
	MM	IN	NM	FT-LB		MM	IN	KG	LB	KG	LB	MM	IN	MM	IN		
BP-T40-RF8-(B)(KIT)	5	No. 10	4.5-8	3.3-5.9	3,300	204	8	1.4	3.08	1.15	2.53	27	1.1	9.5 Hex	3/8 Sq.	75	10.8V (2.0Ah)
BP-T40D-RF8-(B)(KIT)	5	No. 10	4.5-8	3.3-5.9	3,300	207	8.2	1.4	3.08	1.15	2.53	27	1.1	6.35 Hex	1/4 Hex	75	10.8V (2.0Ah)
BP-T50-RF8-(B)(KIT)	6-8	1/4-5/16	7-15	5.1-11.1	3,900	204	8	1.4	3.08	1.15	2.53	27	1.1	9.5 Sq.	3/8 Sq.	76	10.8V (2.0Ah)
BP-T50D-RF8-(B)(KIT)	6-8	1/4-5/16	6.5-13	4.8-9.6	3,900	207	8.2	1.4	3.08	1.15	2.53	27	1.1	6.35 Hex	1/4 Hex	76	10.8V (2.0Ah)
BP-T60-RF8-(B)(KIT)	8	5/16	13-26	9.6-19.2	4,800	209	8.2	1.6	3.52	1.25	2.75	27	1.1	9.5 Sq.	3/8 Sq.	76	14.4V (2.0Ah)
BP-T60D-RF8-(B)(KIT)	8	5/16	13-26	9.6-19.2	4,800	212	8.3	1.6	3.52	1.25	2.75	27	1.1	6.35 Hex	1/4 Hex	77	14.4V (2.0Ah)

\* Base models come with no battery. Batteries are available separately or in tool/kit combinations. Add "KIT" to the end of the model number to order a tool kit, which includes 1 tool, 2 batteries, and 1 battery charger.



10.8 V Battery:  
EYFB32



14.4 V Battery:  
EYFB41



Battery Charger: EYOL82B

## BP-T Series Batteries and Charger

Battery Model #	Description	Voltage	Type	Capacity
EYFB32	Battery for BP-T40 (RF8), BP-T40D (RF8), BP-T50 (RF8), and BP-T50D (RF8) models	10.8V	Li-Ion	2.0Ah
EYFB41	Battery for BP-T60 (RF8) and BP-T60D (RF8)	14.4V	Li-Ion	2.0Ah

Charger Model #	Description	Weight	Input Voltage	Dimensions	Battery Capacity
EYOL82B	Li-Ion battery charger	0.93 kg (2.0 lbs)	120VAC	9.3" D x 7.1" W x 3.6" H	3.0 - 4.2Ah

**BODY JACKET**

**10C-840-1**  
for BP-T40/50 Series

**10E-840-1**  
for BP-T60 Series

\* **E** logo indicates where ERGO-DRIVE sockets/extensions benefit tool operation.

## REVOLUTIONARY

Quantum Leap Forward in Hydraulic Pulse Technology  
Mated to a Powerful Battery Tool

Innovative Elliptical Movement Design with larger blades and elimination of springs  
**Lengthens Service Intervals**  
by as much as **400%** with a high degree of accuracy and a reaction-free operating experience



UBX-T70 Battery Oil Pulse Tool

### Easier, Less Frequent Maintenance

- Pulse unit contains fewer parts, making it easier to service
- Less precise fluid fill requirements do not compromise tool performance

### Improved Operator Comfort

- Short duration, non-mechanical pulsing delivers torque to the fastener with near reaction-free feel
- Lighter tool weight
- Minimal vibration

### Increased Quality and Performance

- Elliptical movement produces more power per pulse
- High pulse frequency and crisp tool shut off results in accurate delivery of torque
- Cycle times on most joints are reduced for more efficient production

### Reduced Cost of Ownership

- Longer fluid life means tool remains in service longer between maintenance
- Maintenance only takes "soft parts" and fewer of those parts
- Fluid costs have been reduced by 40% (when using OEM recommended fluid)



# UBX-T Series Cordless Pulse Tools

## UBX Pulse Unit: Increased Output and Durability

No-spring design means pulse unit houses fewer internal parts, reducing maintenance costs

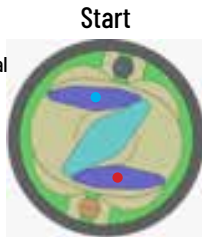

No need to warm up before use



Larger blades move in an elliptical pattern. Pulse force work is done by the inertial movement of the blades, which takes wear off the fluid.

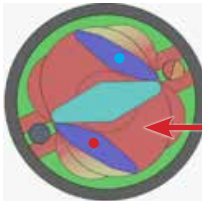

Torque energy "pulse" is more evenly distributed between the blade action and the fluid, which means less stress on the fluid and increased power per pulse.

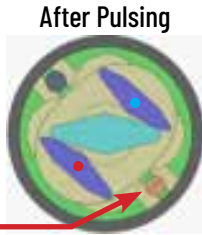

Auto Relief Technology is unaffected by oil degradation

### UBX-T70 SHUT-OFF BATTERY OIL PULSE TOOL

The first tool released in the UBX series is the UBX-T70 Shut-Off Battery Oil Pulse Tool. It features all of the advantages of the innovative UBX pulse unit technology, as well as:

#### Additional Features and Benefits

- Weight reduced by 0.3 lb (140 g) compared to the UDBP-TA70(P)
- On-board LED indicates fastening results
- Number of fastening per minute: 8 (fastening time 0.4 sec.)
- Fastener quantity per full charge: 600 (on a B joint with 1 sec or less freerun)



### UBX-T Series Tools

Model	Nominal Bolt Size		Torque		Weight W/O Battery		Free Speed RPM	Length		Height		Sq. Drive IN
	MM	IN	NM	FT-LB	KG	LB		MM	IN	MM	IN	
UBX-T70*	8 - 12	5/16 - 1/2	25 - 55	18 - 41	w/o battery: 1.28	w/o battery: 2.8	4,800	187	7.4	242	9.5	3/8

\* Base model comes with no battery. Batteries are available separately or in tool/kits combinations.

Add "B" to end of the model number to order 1 tool with 1 battery. Add "KIT" to the end of the model number to order a tool kit, which includes 1 tool, 2 batteries, and 1 battery charger.

### UBX-T Series Battery and Charger

Battery Model #	Description	Voltage	Type	Capacity	
EYFB41	Battery for UBX-T70	14.4V	Li-Ion	2.0Ah	
Charger Model #	Description	Weight	Input Voltage	Dimensions	Battery Capacity
EYOL82B	Li-Ion battery charger	0.93 kg (2.0 lbs)	120VAC	9.3" D x 7.1" W x 3.6" H	3.0 - 4.2Ah



14.4 V Battery: EYFB41



Battery Charger: EYOL82B



# UAN & URW Series Nutrunners

## UAN SERIES ANGLE NUTRUNNERS

Designed for fastening in tight quarters or applications not served well by a pulse tool. The UAN Series transfers torque through beveled angle gears, continuously driving the fastener. When the resistance to rotation overcomes the spring resistance on the clutch, the tool will disengage at the adjusted torque value. Low reaction force characteristics on hard joints make it comfortable for the operator to use. Ideal for applications ranging from 6 - 60 Nm (4 - 44 ft-lb).

- Torque Control
- Electronically Monitored or Controlled type

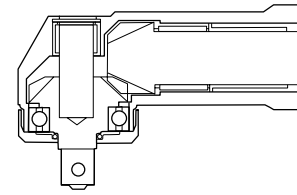

UAN-611R-30C

## UAN Series Angle / Inline Tools

Recommended Air Pressure: 85 psi

Model	Torque Range		Free Speed RPM	Overall Length		Angle Head Height		From Center To Outside		Weight Less Socket		Square Drive IN	Noise Level dB(A)	Air Usage CFM
	NM	FT-LB		MM	IN	MM	IN	MM	IN	KG	LB			
<b>Angle</b>														
UAN-611R-60C	6.5 - 12.0	4.3 - 8.6	620	383	15.1	47	1.9	14.0	0.5	1.6	3.5	3/8	80	21.2
UAN-611R-50C	8.5 - 15.0	5.7 - 10.8	470	373	14.7	47	1.9	14.0	0.5	1.6	3.5	3/8	80	21.2
UAN-611R-40C	10.0 - 18.0	7.2 - 12.9	400	373	14.7	47	1.9	14.0	0.5	1.6	3.5	3/8	80	21.2
UAN-611R-30C	13.0 - 25.0	9.3 - 18.0	270	373	14.7	47	1.9	14.0	0.5	1.6	3.5	3/8	80	21.2
UAN-701R-60C	20.0 - 31.0	14.5 - 23.1	600	445	17.5	47	1.9	14.0	0.5	2.4	5.3	3/8	85	31.8
UAN-701R-40C	28.0 - 45.0	21.0 - 33.3	400	455	17.9	51	2.0	18.0	0.7	2.4	5.3	3/8	85	31.8
UAN-701R-30C	37.0 - 60.0	27.5 - 44.1	300	455	17.9	58	2.3	18.0	0.7	2.4	5.3	1/2	85	31.8

Air Hose Size: 3/8 I.D.

Air Inlet: N.P.T. 1/4

## URW SERIES IN-LINE RATCHET WRENCHES

Designed to set flush over the fastener head, the URW Series is ideal for narrow fastening spaces. Motor torque is transferred from a gear driven, dual lobed cam that pushes a spring loaded push rod, rotating the socket one tooth at a time. A wide variety of socket sizes, head thicknesses, and tool lengths allow the URW Series access to many difficult applications.

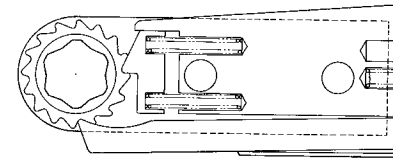

URW-8



URW-9N



URW-10N



URW-12N

## URW Series Ratchet Wrenches

Recommended Air Pressure: 85 psi

Model	Max Torque		Free Speed RPM	Overall Length		Weight		Min/Max Hex Socket Size		Air Usage CFM
	NM	FT-LB		MM	IN	LB	KG	MM	IN	
<b>Straight Head</b>										
URW-6	11	8.1	210	292	11.5	2.5	1.2	6 - 12	1/4 - 7/16	9.9
URW-8N	16	11.8	260	300	11.8	4.2	1.9	7 - 15	7/16 - 9/16	19.5
URW-8	16	11.8	240	360	14.2	5.0	2.3	7 - 15	7/16 - 9/16	19.8
URW-9N	31	22.9	140	380	15.0	5.2	2.4	7 - 15	7/16 - 9/16	23.7
URW-10N	57	42.2	155	394	15.5	5.8	2.7	10 - 19	9/16 - 3/4	25.0
URW-12N	59	43.7	145	397	15.6	5.9	2.7	12 - 23	3/8 - 13/16	25.0

Air Hose Size: 3/8 I.D.

Air Inlet: N.P.T. 1/4

\* E logo indicates where ERGO-DRIVE sockets/extensions benefit tool operation.

# Tubenut & Geared Wrenches

## UOW SERIES OPEN-END NUTRUNNERS

Designed for tubenut fastening, the UOW Series can transfer torque through a variety of options.

- Stall Type – Depending on the application requirements, the standard UOW Series will stall when torque resistance matches power output
- Mechanical Shut-off Type – For greater torque accuracy and less reaction impulse to the operator, the UOW-T Series incorporates a mechanical clutch to shut off the tool at the preset torque
- Electronically Monitored Type – For critical torque applications requiring monitoring or controlling of the fastening torque, the UOW-M Series utilizes a transducer to signal the clutch shut-off
- UOW series incorporates a one-hand, two-step throttle, which automatically reverses the socket to a preset open position

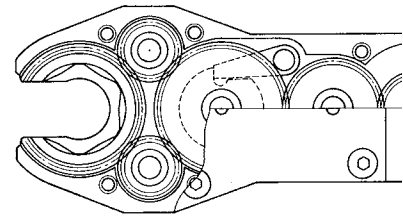

## UOW / UOW-T Series Tubenut Wrenches

Recommended Air Pressure: 85 psi

Model	Max Torque/Range		Free Speed RPM	Overall Length		Weight		Min/Max Hex Socket Size		Noise Level dB(A)	Air Usage CFM
	NM	FT-LB		MM	IN	LB	KG	MM	IN		
<b>Stall</b>											
UOW-T1-10	13	9.6	390	295	11.7	3.3	1.5	7 - 12	1/4 - 7/16	76	10.5
UOW-T1-14	16	11.8	290	311	12.3	3.5	1.6	10 - 17	7/16 - 5/8	76	10.5
UOW-T1-22	24	17.8	220	326	12.8	3.9	1.8	11 - 24	7/16 - 5/8	76	10.5
UOW-T1-30	32	23.7	160	347	13.7	4.4	2.0	14 - 36	5/8 - 1-3/16	76	10.5
<b>Shut-Off Clutch</b>											
UOW-T60-10	4 - 14	3.0 - 10.4	300	370	14.6	4.6	2.1	7 - 12	1/4 - 7/16	76	10.5
UOW-T60-14	5 - 17	3.7 - 12.6	240	385	15.1	4.9	2.2	10 - 17	7/16 - 5/8	76	10.5
UOW-T60-22	7 - 24	5.2 - 17.8	170	400	15.8	5.2	2.4	11 - 24	7/16 - 5/8	76	10.5
UOW-T60-30	10 - 32	7.4 - 23.7	130	420	16.6	5.7	2.6	14 - 36	5/8 - 1-3/16	76	10.5
<b>Geared Wrenches</b>											
UGW-6N	18	13.3	530	310	12.2	3.1	1.4	9 - 12	3/8 - 7/16	76	10.5
UGW-8N	23	17.0	410	322	12.7	3.2	1.5	10 - 17	7/16 - 5/8	76	10.5

Air Hose Size: 3/8 I.D.

Air Inlet: N.P.T. 1/4

# DynaTorque Manual Torque Multipliers



## FEATURES AND BENEFITS

Manual Torque Multipliers offer the perfect, economical solution to high torque bolting applications.

- Superior power to weight ratio
- Delivered torque accuracy +/- 4%
- Anti-Wind Up safety feature (2,800 NM models and up) prevents input device from springing backward when released
- True torque multiplication ratios
- Standard reaction arms supplied. Custom reaction arms/nose extensions available to suit specific applications
- No preventative maintenance required
- Overload protected by shear-drive design (spare torsion shaft included). Easily replace sheared-off pins at the work site

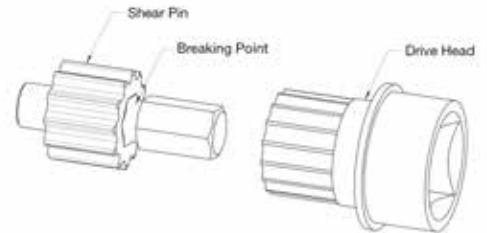

## DynaTorque Manual Torque Multipliers

Model	Input IN	Output IN	Ratio	Max Torque Output		A (MM)	B (MM)	C (MM)	D (MM)	Weight*	
				Nm	Ft-Lb					LB	KG
ATM-800	1/2	3/4	1:3.5	800	590	65	105	132	130	2.9	1.3
ATM-1800	3/4	1	1:3.6	1,800	1,327	90	150	188	132	6.6	3.0
ATM-2800	1/2	1	1:13	2,800	2,066	95	200	240	132	11.5	5.2
ATM-3800	3/4	1	1:13	3,800	2,804	95	200	240	132	11.5	5.2
ATM-5000	3/4	1.5	1:17	5,000	3,690	120	215	272	150	15.4	7.0
ATM-8000	3/4	1.5	1:49	8,000	5,904	132	268	344	200	25.4	11.5
ATM-12000	3/4	1.5	1:58	12,000	8,856	156	272	348	200	30.9	14.0
ATM-16000	3/4	2.5	1:75	16,000	11,808	215	292	370	225	57.3	26.0

\* Weight shown does not include weight of reaction device.

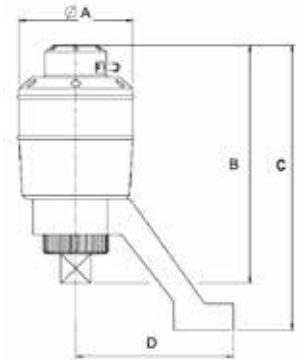

## CARRYING CASE

All DynaTorque Multipliers are supplied in a rugged, weather-resistant, portable carrying case.



# US-LT Pneumatic Screwdrivers

## TORQUE CONTROL AUTOMATIC SHUT-OFF TYPE

- Precise repeatability improves quality
- Minimal wear on internal parts for longer life
- Quick shut off for minimum torque reaction
- Speed choice for flexibility
- Easy external torque adjustment
- Midrange air motor provides high speed during entire cycle
- Ideal for industrial torque control applications



US-LT30B Series



US-LT50B Series



US-LT10B



US-LT20B Series



US-LT40B Series

## US-LT Light Touch Series Inline Push-To-Start Screwdrivers

Recommended Air Pressure: 85 psi

Model	Torque Range		Free Speed RPM	Overall Length		Weight		From Center To Outside		Noise Level dB(A)	Air Usage CFM
	NM	IN-LB		MM	IN	LB	KG	MM	IN		
US-LT10B	0.2 - 0.6	1.8 - 5.3	1,000	191	7.5	0.6	0.3	12.0	0.5	75	5.2
US-LT20B-10	0.4 - 1.1	3.1 - 9.7	1,000	180	7.1	0.7	0.3	13.0	0.5	70	5.6
US-LT20B-18	0.3 - 0.7	2.2 - 6.2	1,800	180	7.1	0.7	0.3	13.0	0.5	70	5.6
US-LT30B-11	1.1 - 2.1	9.7 - 18.5	1,100	187	7.4	0.9	0.4	15.5	0.6	70	7.0
US-LT30B-17	0.7 - 1.5	6.2 - 13.2	1,700	187	7.4	0.9	0.4	15.5	0.6	70	7.0
US-LT30B-23	0.4 - 1.0	3.5 - 8.8	2,300	187	7.4	0.9	0.4	15.5	0.6	71	7.0
US-LT40B-08	1.6 - 4.0	14.1 - 35.2	800	209	8.2	1.4	0.7	16.5	0.6	70	10.5
US-LT40B-15	1.0 - 2.2	6.2 - 19.4	1,500	209	8.2	1.4	0.7	16.5	0.6	70	10.5
US-LT40B-21	1.0 - 1.7	6.2 - 15.0	2,100	209	8.2	1.4	0.7	16.5	0.6	74	10.5
US-LT50B-05	5.0 - 10.2	44.0 - 92.4	480	240	9.5	2.2	1.0	19.5	0.8	74	17.5
US-LT50B-08	3.0 - 5.5	26.4 - 48.4	800	240	9.5	2.2	1.0	19.5	0.8	75	17.5
US-LT50B-17	1.5 - 2.6	9.7 - 23.0	1,700	240	9.5	2.2	1.0	19.5	0.8	75	17.5

Air Hose Size: 1/4 I.D. for US-LT10B - US-LT40B Series - 3/8" I.D. for US-LT50B Series  
Each model is equipped with its standard and alternate clutch springs

Air Inlet: 1/8 for US-LT10B - US-LT20B Series - 1/4" for US-LT30B - US-LT50B Series

### External Torque Adjustment (Air Shut-Off)

Set the hand driver into the key hole on the Adjusting Gear, turn clockwise to increase torque. Turn counter clockwise to decrease torque.

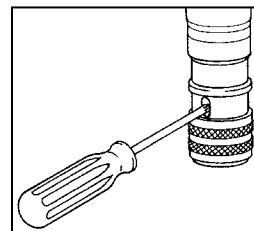

# US-LT Pneumatic Screwdrivers



US-LT30B\_C Series



US-LT40B\_C Series



US-LT40\_C Series



US-LT30BL Series



US-LT40BL Series

## US-LT Light Touch Series Angle and Lever Push-To-Start Screwdrivers

Recommended Air Pressure: 85 psi

Model	Torque Range Soft Joint		Free Speed RPM	Overall Length		Weight		From Center to Outside		Hex Bit Or Drive Size IN	Noise Level dB(A)	Air Usage CFM
	NM	IN-LB		MM	IN	LB	KG	MM	IN			
<b>Angle</b>												
US-LT30B-11C	1.1 - 2.1	3.5 - 18.5	1,100	298	10.7	1.5	0.7	36	1.4	1/4	73	7.0
US-LT30B-17C	0.7 - 1.5	3.5 - 13.2	1,700	295	10.7	1.5	0.7	36	1.4	1/4	73	7.0
US-LT40B-03C	5.0 - 10.0	44 - 88	300	359	14.2	2.4	1.1	35.5	1.4	3/4	72	10.5
US-LT40B-05C	2.3 - 5.7	20.0 - 49.5	500	322	13.0	2.1	0.9	38.5	1.5	1/4	75	10.5
US-LT40B-08C	1.6 - 4.0	8.7 - 34.7	800	320	12.8	2.0	0.9	36	1.4	1/4	75	10.5
US-LT40B-15C	1.0 - 2.2	8.7 - 19.4	1,500	320	12.8	2.0	0.9	36	1.4	1/4	75	10.5
US-LT40-03C	5.0 - 10.0	43.4 - 86.8	300	360	14.2	2.4	1.1	35.5	1.4	1/4 Sq.	72	10.5
US-LT40-05C	2.3 - 5.7	20.0 - 50.2	500	322	13.0	2.1	0.9	35.5	1.4	1/4 Sq.	75	10.5
US-LT40-08C	1.6 - 4.0	8.7 - 34.7	800	320	12.8	2.0	0.9	32	1.3	1/4 Sq.	75	10.5
<b>Lever</b>												
US-LT30BL-11	1.1 - 2.1	9.7 - 18.5	1,100	229	8.2	1.2	0.5	15	0.6	1/4	70	5.2
US-LT30BL-17	0.7 - 1.5	6.2 - 13.2	1,700	229	8.2	1.2	0.5	15	0.6	1/4	70	5.2
US-LT30BL-23	0.4 - 1.0	3.5 - 8.8	2,300	229	8.2	1.2	0.5	15	0.6	1/4	70	5.2
US-LT40BL-08	1.6 - 4.0	14.1 - 35.2	800	249	9.8	1.5	0.7	17	0.7	1/4	70	5.6
US-LT40BL-15	1.0 - 2.2	8.8 - 19.4	1,500	249	9.8	1.5	0.7	17	0.7	1/4	70	5.6

Angle Head Height: 32 - 36 mm

Air Inlet: N.P.T. 1/4"

Air Hose Size: 1/4" I.D. for all models



US-LT31PB Series



US-LT41PB Series



US-LT51PB Series



US-LT60P Series

## US-LT Light Touch Series Pistol Push-To-Start Screwdrivers

Recommended Air Pressure: 85 psi

Model	Torque Range (Soft Joint)		Free Speed RPM	Overall Length		Weight		From Center to Outside		Noise Level dB(A)	Air Usage CFM
	NM	IN-LB		MM	IN	LB	KG	MM	IN		
US-LT31PB-05	2.4 - 5.0	21.1 - 44.0	500	189	8.2	1.9	0.9	16	0.6	70	7.0
US-LT31PB-11	1.1 - 2.1	9.7 - 18.5	1,100	170	7.0	1.6	0.7	16	0.6	70	7.0
US-LT31PB-17	0.7 - 1.5	6.2 - 13.2	1,700	170	7.0	1.6	0.7	16	0.6	70	7.0
US-LT31PB-23	0.4 - 1.0	3.5 - 8.8	2,300	170	7.0	1.6	0.7	16	0.6	70	7.0
US-LT41PB-08	1.6 - 4.0	14.0 - 35.2	800	175	7.7	1.9	0.9	17	0.6	70	10.5
US-LT41PB-15	1.0 - 2.2	8.8 - 19.4	1,500	175	7.7	1.9	0.9	17	0.6	70	10.5
US-LT41PB-21	1.0 - 1.7	8.8 - 15.0	2,500	175	7.7	1.9	0.9	17	0.6	74	10.5
US-LT51PB-05	5.0 - 10.5	44.0 - 92.4	480	198	8.5	2.6	1.2	20	0.8	74	17.5
US-LT51PB-08	3.0 - 5.5	26.4 - 48.4	800	198	8.5	2.6	1.2	20	0.8	75	17.5
US-LT51PB-17	1.5 - 2.6	13.2 - 22.9	1,700	198	8.5	2.6	1.2	20	0.8	75	17.5
US-LT60P-03*	7.0 - 20.0	61.6 - 176.0	320	230	9.1	3.7	1.7	22	0.9	75	21.0
US-LT60P-07*	4.0 - 10.0	35.2 - 88.0	650	230	9.1	3.7	1.7	22	0.9	76	21.0
US-LT60P-11*	4.0 - 7.0	35.2 - 61.6	1,100	230	9.1	3.7	1.7	22	0.9	77	21.0

Air Hose Size: 1/4 I.D. for US-LT31PB & US-LT41PB Series

Air Inlet: N.P.T. 1/4"

3/8 I.D. for US-LT31PB-05, US-LT51PB Series & US-LT60P Series

\* Optional 3/8" Sq. Drive available for US-LT60P Series ADD (P) to Model Number

# US-LT Pneumatic Screwdriver Accessories



## US-LT Screwdriver Optional Clutch Springs

Model	Clutch Springs Provided		Recommended Torque Range		Clutch Spring Code Number
	Standard	Option	Hard Joint		
			Nm	in-lb	
US-LT10B	Black		0.20 - 0.60	1.7 - 5.2	976-379-0
US-LT20B-10	Black		0.34 - 1.10	3.0 - 9.5	976-432-0
		Red	0.20 - 0.70	1.7 - 6.1	976-431-0
		Yellow	0.15 - 0.34	1.3 - 3.0	976-430-0
US-LT20B-18	Red		0.24 - 0.67	2.2 - 6.1	976-431-0
		Yellow	0.15 - 0.34	1.3 - 3.0	976-430-0
US-LT20B-26	Yellow		0.15 - 0.34	1.3 - 3.0	976-430-0
US-LT31PB-05	Red		2.35 - 5.00	20.9 - 44.0	976-493-0
		Pink	0.98 - 2.74	8.7 - 24.3	976-471-0
US-LT30 Series, 1,100 rpm	Blue		0.98 - 2.1	8.7 - 18.5	976-472-0
		Red	0.67 - 1.76	6.1 - 15.6	976-493-0
		Pink	0.39 - 0.98	3.5 - 8.7	976-471-0
		(not included)	1.22 - 2.74	10.8 - 24.3	976-504-0
US-LT30 Series, 1,700 rpm	Red		0.67 - 1.47	6.1 - 13.0	976-493-0
		Pink	0.39 - 0.98	3.5 - 8.7	976-471-0
US-LT30 Series, 2,300 rpm	Pink		0.39 - 0.98	3.5 - 8.7	976-471-0
US-LT40-03C	Red		4.90 - 9.80	43.4 - 86.8	976-516-0
US-LT40 Series, 800 rpm	Black		1.57 - 3.92	13.9 - 34.7	976-515-0
		Red	0.98 - 2.17	8.7 - 19.1	976-516-0
		Yellow	0.98 - 1.67	8.7 - 14.8	976-517-0
US-LT40 Series, 1,500 rpm	Red		0.98 - 2.17	8.7 - 19.1	976-516-0
		Yellow	0.98 - 1.67	8.7 - 14.8	976-517-0
US-LT40 Series, 2,100 rpm	Yellow		0.98 - 1.67	8.7 - 14.8	976-517-0
US-LT50 Series, 500 rpm	Black		4.9 - 10.3	43.4 - 91.1	976-620-0
		Red	2.9 - 5.4	26.1 - 47.7	976-614-0
		Yellow	1.4 - 2.5	13.0 - 22.6	976-588-0
US-LT50 Series, 800 rpm	Red		2.7 - 5.4	24.3 - 47.7	976-614-0
		Yellow	1.4 - 2.5	13.0 - 22.6	976-588-0
US-LT50 Series, 1,700 rpm	Yellow		1.4 - 2.6	13.0 - 23.0	976-588-0

# US & US-LD Pneumatic Screwdrivers



US-LD40P-15



US-LD50P-08



US-3.5ACB

## US-LD Direct Drive Series Screwdrivers

Recommended Air Pressure: 72 psi

Model	Max Torque Soft Joint		Max Torque Hard Joint		Free Speed RPM	Overall Length		Weight		From Center to Outside		Noise Level dB(A)	Air Usage CFM
	NM	FT-LB	NM	FT-LB		MM	IN	LB	KG	MM	IN		
Pistol													
US-LD40P-08	4.8	3.6	5.7	4.2	940	130	5.1	1.5	0.7	17	0.7	70	14.0
US-LD40P-15	3.0	2.2	3.2	2.4	1,700	130	5.1	1.5	0.7	17	0.7	70	14.0
US-LD40P-21	2.0	1.5	2.8	2.1	2,500	130	5.1	1.5	0.7	17	0.7	74	14.0
US-LD50P-05	10.0	7.4	11.2	8.3	500	153	6.0	2.0	0.9	20	0.8	74	17.5
US-LD50P-08	6.5	4.8	7.8	5.8	900	153	6.0	2.0	0.9	20	0.8	75	17.5
US-LD50P-17	3.5	2.6	5.9	4.4	1,900	150	5.9	2.0	0.9	20	0.8	75	17.5

Angle	Max Torque Soft Joint		Max Torque Hard Joint		Capacity (Screw Size)		Free Speed RPM	Overall Length		Weight		From Center To Outside		Noise Level dB(A)	Air Usage CFM
	NM	FT-LB	NM	FT-LB	MM	IN		MM	IN	LB	KG	MM	IN		
US-3.5ACB	1.75	1.1	2.5	1.8	4	No. 8	2,000	200	7.9	1.4	0.7	10.0	0.4	85	7.0

Air Hose Size: 1/4" I.D. Air Inlet: N.P.T. 1/4"



US-3.5B



US-5

## US Cushion Clutch Series Screwdrivers

Recommended Air Pressure: 57 psi

Model	Capacity (Screw Size)		Free Speed RPM	Overall Length		Weight Less Bit		From Center to Outside		Noise Level dB(A)	Air Usage CFM
	MM	IN		MM	IN	LB	KG	MM	IN		
US-3.5B	4	No. 8	2,000	214	8.5	1.4	0.6	17	0.7	75	7.0
US-5	5	No. 10	1,400	236	7.1	2.4	1.1	21	0.8	75	7.0

Air Hose Size: 1/4" I.D. Air Inlet: N.P.T. 1/4"



US-350PW



US-450PW



US-652PW



US-450WB

## US Impact Series Screwdrivers

Model	Capacity (Screw Size)		Free Speed RPM	Overall Length		Weight Less Bit		From Center To Outside		Noise Level dB(A)	Air Usage CFM
	MM	IN		MM	IN	LB	KG	MM	IN		
Pistol											
US-350PW	4	No. 8	15,000	121	4.8	1.2	0.5	17	0.7	81	7.0
US-450PW	5	No. 10	14,000	151	5.9	1.7	0.8	17	0.7	79	7.0
US-652PW	6	1/4	9,000	155	6.1	1.9	0.9	23	0.9	79	12.4
Straight											
US-6W	6	1/4	9,500	187	7.4	1.8	0.8	22.5	0.9	85	10.5
US-450WB	5	No. 10	11,000	161	6.3	1.2	0.6	18.5	0.7	80	7.0

Air Hose Size: 1/4" I.D. Air Inlet: N.P.T. 1/4"  
(R) Denotes Directional Muffled Rear Exhaust option

Recommended air pressure: 57 psi for US-350PW, US-450PW, US-6W, and US-450WB / 72 psi for US-652PW.  
NOTE: Additional models available. Please contact AIMCO, 1-503-254-6600, or toll free 1-800-852-1368

# Signature Series Shut-Off Impact Cordless Tools

Tested and PROVEN to BEAT the competition in vibration and noise levels

These tools outperform the competition in number of rundowns per battery charge



## SHUT-OFF IMPACT TOOLS

The Signature Series Impact Shut-Off Pistol Tool can operate as a standard impact wrench or as an impact wrench with a programmable shut-off point, preventing over-torquing. These innovative tools deliver a torque range of 3 – 120 Nm (2 – 89 ft-lb). No torque reaction, coupled with the ergonomic, lightweight design and reduced vibration, helps to prevent user injury.



## FEATURES AND BENEFITS

- Brushless motor provides longer motor life and increased efficiency
- Easy-to-read process information lights
- Advanced shut-off system
- LED light for work-area illumination
- Programmable buttons for easy operation
- Li-Ion battery provides long battery life
- Mini USB port for connection to optional programmer (SPC-2PGM)

## SIW Signature Series Cordless Impact Tools

Model	Torque Range		Max Torque		Free Speed	Battery (V)	Weight		Anvil Size	Noise Level dB(A)
	NM	FT-LB	NM	FT-LB			LB	KG		
SIW-P2525Q	3 - 25	2 - 18	40	30	2,400	20	2.2	1	1/4 QC	71
SIW-P3225Q	6 - 32	4 - 24	90	66	2,400	20	2.2	1	1/4 QC	71
SIW-P3238	6 - 32	4 - 24	90	66	2,400	20	2.2	1	3/8 Sq Dr	71
SIW-P5538	15 - 55	11 - 41	120	90	2,400	20	2.4	1.1	3/8 Sq Dr	71
SIW-P5550	15 - 55	11 - 41	120	90	2,400	20	2.4	1.1	1/2 Sq Dr	71
SIW-P10050	25 - 100	18 - 74	180	133	2,400	20	2.4	1.1	1/2 Sq Dr	71
SIW-P12050	30 - 120	22 - 89	210	155	2,400	20	2.9	1.3	1/2 Sq Dr	71

Shut-Off Impact Tools Include: Body Jacket, Bail, and one (1) 18V Li-Ion Battery

## BATTERY AND CHARGER

The Signature Series Shut-Off Impact Tool battery features a slim profile design and a slide mount connection to the tool, which ensures durability and makes changing out batteries quick and easy.

Battery Model #	Voltage / Capacity	Type
SIW-B20LI	20V, 2.0 Ah	Li-Ion
SIW-B20LI-HC	20V, 4.0 Ah	Li-Ion
Charger Model #	Output	Input
SIW-C18-20	18 - 20V, 4.0 A	100 - 240VAC, 50-60 Hz



## ACCESSORIES

Model #	Description
BJ10091	Grey Body Jacket Cover
SIW-PBL	Suspension Bail
SIW-38PR	Pin Retainer Kit, 3/8" Drive
SIW-50PR	Pin Retainer Kit, 1/2" Drive





# Signature Series Precision Clutch Cordless Tools

Quick shut-off, precision clutch minimizes torque reaction and ensures precise application of torque

## PRECISION CLUTCH TOOLS

Signature Series precision clutch tools feature a quick-releasing clutch that delivers accuracy across multiple joint types. Constructed of precision machined parts, this tool guarantees accuracy and durability over the life of the tool.

## FEATURES AND BENEFITS

- LED indicator provides simple process information to the operator. The signal is visible from any angle
- Press button for easy F/R operation
- LED light for working in dark areas
- Trigger repeat protection avoids double hits on already seated screws
- Easily attached sliding battery system
- Mini USB port for connection to optional programmer (SPC-2PGM)
- Li-Ion battery pack delivers longer run time
- Ergonomic handle design provides outstanding balance and weight and is ideal for accessing hard-to-reach locations
- Angle tool enables multiple head positions



## SPC Signature Series Cordless Clutch Tools

Model	Torque Range		Free Speed RPM Range (Programmable with Programmer Accessory)	Battery Voltage	Tool Weight (w/o Battery)		Anvil Size
	NM	FT-LB			LB	KG	
<b>Pistol*</b>							
SPC-P23250	.8 - 3	.6 - 2.2	500 - 1,550	18V	2.1	.95	1/4" QC
SPC-P26250	1 - 6	.7 - 4.4	300 - 1,000	18V	2.1	.95	1/4" QC
SPC-P29250	1.5 - 9	1.1 - 6.6	300 - 800	18V	2.1	.95	1/4" QC
SPC-P212250	2 - 12	1.5 - 8.8	250 - 600	18V	2.1	.95	1/4" QC
<b>Right Angle**</b>							
SPC-A210250	3 - 12	2.2 - 8.8	400 - 1,000	18V	3.5	1.6	1/4" QC
SPC-A21025	3 - 12	2.2 - 8.8	400 - 1,000	18V	3.5	1.6	1/4" Sq
SPC-A21038	3 - 12	2.2 - 8.8	400 - 1,000	18V	3.5	1.6	3/8" Sq
SPC-A216250	5 - 18	3.7 - 13.3	300 - 600	18V	3.5	1.6	1/4" hex
SPC-A21625	5 - 18	3.7 - 13.3	300 - 600	18V	3.5	1.6	1/4" Sq
SPC-A21638	5 - 18	3.7 - 13.3	300 - 600	18V	3.5	1.6	3/8" Sq
SPC-A23038	8 - 30	5.9 - 22	250 - 480	18V	3.5	1.6	3/8" Sq
SPC-A23538	10 - 35	7.4 - 25.8	220 - 330	18V	3.5	1.6	3/8" Sq
SPC-A25038	10 - 50	7.4 - 37	200 Non-Programmable Fixed Speed***	18V	5.3	2.4	3/8" Sq
SPC-A27038	20 - 70	14.8 - 51.7	170 Non-Programmable Fixed Speed***	18V	6.3	2.9	3/8" Sq
SPC-A210050	35 - 100	26 - 74	119 Non-Programmable Fixed Speed***	18V	7.4	3.4	1/2" Sq

\* Pistol Grip Tools include: Torque Adjustment Tool and one (1) 18V Li-Ion Battery

\*\* Angle Nutrunners include: Torque Adjustment Tool, Head Indexing Spanner Wrench, and one (1) 18V Li-Ion Battery

\*\*\* High torque tools feature fixed RPM

# Signature Series Precision Clutch Cordless Tool Accessories

## BATTERY AND CHARGER

One universal battery and charger interface with all of the Signature Series Precision Clutch tools. Each tool utilizes the same lightweight 18V Li-Ion battery, which provides superior battery life. The charger accepts input AC power of 100 – 240VAC, making use simple anywhere in the world.

### Batteries and Charger for SPC Signature Series Cordless Clutch Tools

Battery Model	Voltage	Type	Capacity	Weight
SPC-B218LI	18V	Li-Ion	2.0 Ah	.8 Lb/.4 kg
SPC-B218LI-HC	18V	Li-Ion	4.0 Ah	1.4 Lb/.64 kg

Charger Model	Output	Input	Dimensions (W/O Battery)	Weight
SPC-C218-19	18V-19.2V 3.0 A	100-240VAC 50-60 Hz	6.25" deep x 5" wide x 3.5" tall 158.75 mm x 127 mm x 89 mm	1.2 Lb/.54 kg



## PRECISION CLUTCH TOOL ATTACHMENTS

A wide variety of special heads and attachments can be fitted to Signature Series Angle Nutrunners. Contact your AIMCO representative for assistance, 1-503-254-6600, or toll free 1-800-852-1368.



## TOOL SPEED PROGRAMMER

Each Signature Series battery tool has programmable features that enhance operator efficiency.



Programmable features include:

- Tool speed control from minimum (1,500 rpm) to maximum (2,400 rpm) speed in 50 rpm increments
- Forward/Reverse Mode - Three setting options
- Two-stage trigger delay control
- Screw count / impact count
- Supervisor level "lock-out" control

Additionally, the Signature Series battery tool has an integrated mini USB connector that couples to the Signature Series Programmer module. Simply connect the tool to the Programmer Module and flash the tool to the desired RPM. The programmed RPM will remain until a change is desired.

## QUICK CLIP



The two piece Quick Clip comes with a belt clip and a stretch cord attachment for a pistol tool. The patented ball feature allows for quick and easy release.



## TOOL BASKETS

AIMCO tool baskets can be affixed to a bench or rack and can be used for either a pistol or right angle tool.

## BODY JACKETS

Prevent damage to the workpiece.

Model	Description
BJ10082	Clear Body Jacket for Signature Series Precision Clutch Pistol Tools
BJ10083	Clear Body Jacket for Signature Series Precision Clutch Angle Nutrunners

# Electric Screwdrivers

## Electra SERIES

- Available in push-to-start and lever start styles
- Ergonomic design – Lightweight, compact housings ensure operator comfort during operation
- Accurate torque control – Precise controlled fastening with automatic shut-off clutches
- External brush replacement – Virtually no down time for brush replacement
- External torque adjustment – Torque level can be easily adjusted by simply turning the external adjustment ring



- UL Listed and CE Certified – Drivers meet electrical safety standards in both the U.S. and Europe
- Direct plug-in style – Offers easy and convenient start-up (certain models), simply plug it in
- State-of-the-art motor design – Ensures comfortable grip temperature for operator and extended motor life

### Electra® Series Screwdrivers

Model	Torque Range		Free Speed RPM	Weight		Length		Hex Drive		Power Source
	IN-LB	KGf-CM		LB	KG	IN	MM	IN	MM	
Push-To-Start Direct Plug-In Series										
AE-5681 (Includes torque cover)	3.5 - 15.6	4 - 18.0	1,000	1.2	0.5	9.3	237	1/4	6.4	115V AC*
AE-8681 (Includes pistol grip handle adapter)	15 - 45	23.0 - 51.8	600	1.6	0.7	10.6	269	1/4	6.4	115V AC*
Low-Voltage Lever Start Series (Requires External Power Supply)										POWER SUPPLY:
AE-2020	.35 - 1.3	.40 - 1.5	720	0.7	0.3	8.0	203	1/4	6.4	See page 29 for required power supplies
AE-4020	.9 - 5	1.0 - 6.0	720	0.7	0.3	8.0	203	1/4	6.4	
AE-4520	1.3 - 8.7	1.5 - 10.0	720	0.7	0.3	8.0	203	1/4	6.4	
AE-7010	6.1 - 17.4	7.0 - 20.0	750	1.4	0.6	9.3	236	1/4	6.4	
AE-8010	10.4 - 26.0	12.0 - 29.9	550	1.4	0.6	9.3	236	1/4	6.4	
Low-Voltage Push-To-Start Series (Requires External Power Supply)										
AE-7010PS	6.1 - 17.4	7.0 - 20.0	750	1.4	0.6	9.3	236	1/4	6.4	
AE-8010PS	10.4 - 26.0	12.0 - 29.9	550	1.4	0.6	9.3	236	1/4	6.4	

\* 220V AC is available upon request. Contact AIMCO at 1-503-254-6600, or toll free 1-800-852-1368.

### ELECTRA® LOW ESD SERIES

- Grounded bit – Grounded chuck assembly routes any existing charge to ground
- Carbonized housing – Handle material and buttons are constructed of carbonized plastic throughout, enabling any charge received by the handle to be routed to ground
- Long-Lasting ESD resistant handle – Material will maintain its integrity for the life of the handle, unlike coatings or paints



### Electra® Low ESD Series Screwdrivers

Model	Torque Range		Free Speed RPM	Weight		Length		Hex Drive		Power Source
	IN-LB	KGf-CM		LB	KG	IN	MM	IN	MM	
AE-4520ESD*	1.3 - 8.7	1.5 - 10.0	720	0.9	0.4	8.0	204	1/4	6.4	35V DC
AE-5681ESD	3.5 - 15.6	4 - 18.0	1,000	1.2	0.5	9.3	237	1/4	6.4	115V AC**

\* Low-voltage units require an external power supply.

\*\* 220V AC is available upon request. Contact AIMCO at 1-503-254-6600, or toll free 1-800-852-1368.

# Electric Screwdrivers

## ELECTRA® SLIP CLUTCH SERIES

- High-speed performance – For quick and consistent assembly and disassembly
- Maximum ergonomics and convenience – Offers a combination of a slip clutch with a high speed motor to provide low torque reaction; one of the best power-to-weight ratios in the industry
- Added maintenance feature – LED light indicates when to change brushes. Brush cap contains a switch that shuts off the power during brush replacement
- Direct 110V plug-in – Eliminates the need for an external power supply



- 1/4" hex quick change chuck for easy bit changes
- External torque collar for easy torque adjustment.

## Electra® Slip Clutch Series Screwdrivers

Model	Recommended Torque Range		Free Speed RPM	Weight		Length		Hex Drive		Power Source
	IN-LB	KGF-CM		LB	KG	IN	MM	IN	MM	
AE-2015	4.3 - 21.7	5.0 - 25.0	1,000	1.2	.55	9.2	234	1/4	6.4	110 V / 120V AC*

\*\* 220V AC is available upon request. Contact AIMCO at 1-503-254-6600, or toll free 1-800-852-1368.

## PRECISION SERIES

- For low torque applications
- Featuring ergonomic design
- Comes with options such as long-life brushless motors and adjustable speed power supplies



## STANDARD MODELS

- Optional speed control power supply – Enables infinite control from 20% to 100% of maximum tool speed and adjustable soft start to minimize cross threading
- Ergonomic housing – Oval shape conforms to hand
- Duralite – Casing material provides a secure grip
- Feather touch integrated lever reduces travel and stress. Requires only 2 mm of travel to activate
- External torque control – Twist and go

## EXTENDED LIFE MODELS

- Sealed Swiss motor – For higher duty cycles, longer life, and less maintenance. Sealed casing means no brush changes are necessary
- Extended warranty on tool motor – Three year standard motor warranty
- Compact power supply – Makes setup a breeze

## Electra® Precision Series Screwdrivers

Model	Torque Range		Free Speed RPM	Weight		Length		Hex Drive IN	
	IN-LB	KGF-CM		LB	KG	IN	MM		
Standard									
AE-6300	.85 - 5.0	1.0 - 5.8	725	0.9	0.4	8.5	216	1/4	
AE-6450	1.3 - 8.7	1.5 - 10.0	770	0.9	0.4	8.5	216	1/4	
High Speed									
AE-6300S	.35 - 4.3	0.4 - 5.0	920	0.9	0.4	8.5	216	1/4	
AE-6450S	1.3 - 8.7	1.5 - 10.0	920	0.9	0.4	8.5	216	1/4	
Extended Life									
AE-6300M	1.0 - 5.5	1.1 - 6.3	550	0.9	0.4	8.5	216	1/4	

# Electric Screwdrivers



AE-224PS  
AE-278PS



APM-30

## Electra® Series Power Supplies

Model	Compatible Screwdrivers	Tool RPM	Voltage Conversion	Dimensions	Weight	
					LB	KG
AE-224PS	AE-2020 AE-2020ESD AE-4020 AE-4520 AE-4520ESD	720	110V AC - 220V AC 35V DC	2.6 x 1.6 x 5.0 66 x 41 x 127 mm	1.0	.45
AE-278PS	AE-7010 AE-7010PS	STANDARD	110V AC - 220V AC 30V DC	1.6 x 5.0 x 2.6 41 x 127 x 66 mm	1.0	.45
APM-30	AE-6300M	550	110V AC - 220V AC 30V DC	2.1 x 3.4 x 1.9 53 x 87 x 48 mm	0.4	0.2



## DIGITAL FASTENING COUNTER

The AM Series fastener counter verifies and error-proofs the assembly process.

- Buzzer notifies of missing screws, incomplete fastening, and thread damage
- Counts up to 60,000 units and up to 99 screws per unit
- Connects easily to automation equipment using standard input/output signals
- Large LCD screen is easy to read. A green screen indicates OK fastening, a red screen indicates NG

## Digital Fastening counters for Electra® Series Screwdrivers

Model	Compatible Screwdrivers
AM-45	For AE-2020, AE-4020, AE-4520 Standard and ESD types
AM-65	For AE-7010, AE-7010PS, AE-8010 and AE-8010PS

## OPTIONAL ACCESSORIES



### Angle Head Attachments

Available for lever start series.  
Not available for Low ESD Series.



### Pistol Grip Handle

Converts to a pistol style driver for horizontal fastening. Available for Trigger Start only (included with AE-8681).



### Torque Cover

Prevents accidental torque adjustment by the operator (included with AE-5681).

## Electra® Series Screwdriver Accessories

Item	Model	Compatible Screwdrivers
Angle Head Attachments	AE-2045A	For AE-2020, AE-4020, AE-4520
	AE-7080A	For AE-7010, AE-8010
Pistol Grip Handle	AE-PG7080	For AE-7010, AE-7010PS, AE-8010, AE-8010PS
Torque Cover	AE-TC2040	For AE-2020, AE-4020, AE-4520
	AE-TC7080	For AE-7010, AE-7010PS, AE-8010, AE-8010PS
	4H2055	For AE-8681

# Impact Tools

## UW-SERIES IMPACT TOOLS

UW-Series impact tools offer fast, economical operation in high-volume heavy assembly applications.

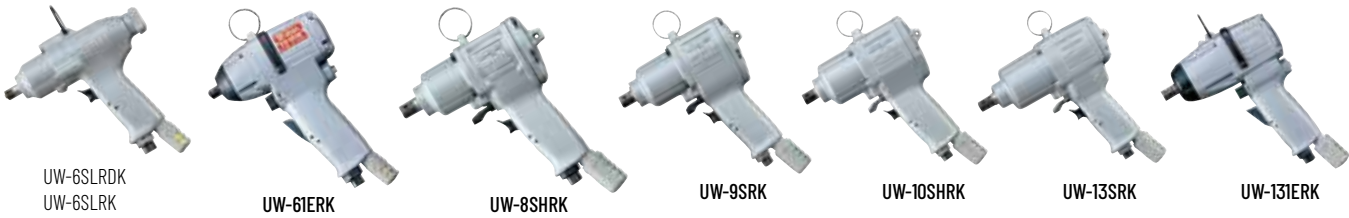

UW-6SLRDK  
UW-6SLRK

UW-61ERK

UW-8SHRK

UW-9SRK

UW-10SHRK

UW-13SRK

UW-131ERK

## UW Series Twin Hammer Pistol Impact Wrenches

Recommended Air Pressure: 85 psi

Model	Capacity		Torque Range (Approx)		Speed RPM	Overall Length		Weight		From Center to Outside		Sq. Dr. or Hex Size IN	Noise Level dB(A)	Average Air Consumption
	MM	IN	NM	FT-LB		MM	IN	KG	LB	MM	IN			
UW-6SLRDK	6	1/4	6.9 - 18	5 - 13	8,500	175	6.9	1.0	2.1	31.0	1.2	1/4 Hex	91	12.4
UW-6SLRK	6	1/4	7.8 - 19	6 - 14	8,500	175	6.9	1.0	2.1	31.0	1.2	1/4 Sq.	92	12.4
UW-61ERK	8	5/16	14 - 40	10 - 30	7,300	150	5.9	1.5	3.3	29.5	1.2	3/8 Sq.	91	12.4
UW-8SHRK	8	5/16	18 - 40	13 - 30	7,300	172	6.8	1.6	3.4	31.0	1.2	1/2 Sq.	93	14.0
UW-9SRK	10	3/8	35 - 87	26 - 64	7,000	178	7.0	1.8	3.9	34.0	1.3	1/2 Sq.	93	16.0
UW-10SHRK	12	1/2	47 - 170	35 - 125	6,000	183	7.2	2.1	4.7	30.5	1.4	1/2 Sq.	95	16.0
UW-13SRK	13	1/2	88 - 250	65 - 184	6,000	215	8.5	2.6	5.7	37.5	1.5	1/2 Sq.	95	16.0
UW-131ERK	13	1/2	84 - 260	62 - 192	5,500	205	8.1	3.0	6.5	37.5	1.5	1/2 Sq.	97	19.4

Air Hose Size: 3/8" I.D. Air Inlet: N.P.T. 1/4" NOTE: Additional models available. Please contact AIMCO, 1-503-254-6600, or toll free 1-800-852-1368.



UW-6SSLRDK

UW-6SSHRDK  
UW-6SSHRK

UW-13SSK

UW-401L

## UW Series Twin Hammer In-Line Impact Wrenches

Recommended Air Pressure: 85 psi

Model	Capacity		Torque Range (Approx)		Speed RPM	Overall Length		Weight		From Center to Outside		Sq. Dr. or Hex Size IN	Noise Level dB(A)	Average Air Consumption
	MM	IN	NM	FT-LB		MM	IN	KG	LB	MM	IN			
UW-6SSRK	6	1/4	9.8 - 26	7 - 19	7,500	225	8.9	1.0	2.1	29.5	1.2	3/8 Sq.	91	10.5
UW-6SSLRDK	6	1/4	6.9 - 18	5 - 13	8,500	239	9.4	0.9	1.9	31.0	1.3	1/4 Hex	91	10.5
UW-6SSHRDK	8	5/16	15 - 30	11 - 22	7,300	249	9.8	1.3	2.8	27.5	1.1	1/4 Hex	91	12.4
UW-6SSHRK	8	5/16	22 - 50	16 - 37	7,300	249	9.8	1.3	2.8	27.5	1.1	3/8 Sq.	91	12.4
UW-13SSK	13	1/2	89 - 250	66 - 184	6,300	281	11.1	3.2	7.0	39.0	1.5	1/2 Sq.	97	19.4
UW-401	38	1-1/2	880 - 2,500	649 - 1,844	3,200	494	19.5	15.1	33.2	62.5	2.5	1 Sq.	110	42.4
UW-401L	38	1-1/2	790 - 2,300	583 - 1,696	3,200	654	25.8	16.5	36.3	62.5	2.5	1 Sq.	110	42.4

Air Hose Size: 3/8" I.D., 1/2" I.D. for UW-401 and UW-401L models Air Inlet: N.P.T. 1/4" NOTE: Additional models available. Please contact AIMCO, 1-503-254-6600, or toll free 1-800-852-1368.

### Impact Tools Model Number Key

UW-SH = Pistol grip  
 UW-SSH = Straight handle  
 UW-CSH = Angle head  
 UW-P = Pistol grip for 140 and 381 series

+ L = Long anvil  
 + R = Rear exhaust  
 + K = Lightweight  
 + DK = Driver-type anvil, lightweight

# Impact Tools



UW-6CShrk



UW-13CSK

## UW Series Twin Hammer Angle Impact Wrenches

Recommended Air Pressure: 85 psi

Model	Capacity		Torque Range (Approx)		Speed RPM	Overall Length		Weight		From Center to Outside		Sq. Dr. or Hex Size IN	Noise Level dB(A)	Average Air Consumption
	MM	IN	NM	FT-LB		MM	IN	KG	LB	MM	IN			
UW-6CShrk	8	5/16	19 - 41	14 - 30	7,300	282	11.1	1.7	3.8	27.5	1.1	3/8 Sq.	94	10.5
UW-13CSK	13	1/2	75 - 200	55 - 148	6,500	374	14.7	5.2	11.4	39.0	1.5	1/2 Sq.	97	26.5

Air Hose Size: 3/8" I.D. Air Inlet: N.P.T. 1/4" NOTE: Additional models available. Please contact AIMCO, 1-503-254-6600, or toll free 1-800-852-1368.



UW-140P(WR)



UW-220P  
UW-220PL



UW-251P



UW-381  
UW-381L



UW-381P

## UW Series Swing Hammer Impact Wrenches

Recommended Air Pressure: 85 psi

Model	Capacity		Torque Range (Approx)		Speed RPM	Overall Length		Weight		From Center to Outside		Sq. Dr. or Hex Size IN	Noise Level dB(A)	Average Air Consumption
	MM	IN	NM	FT-LB		MM	IN	KG	LB	MM	IN			
UW-140P(WR)	12	1/2	70 - 210	52 - 155	6,500	200	7.9	2.7	5.9	33.0	1.3	1/2 Sq.	93	25.0
UW-220P	19	3/4	300 - 700	221 - 516	5,500	230	9.1	2.8	9.6	42.0	1.7	3/4 Sq.	95	25.0
UW-220PL	19	3/4	300 - 700	221 - 516	5,500	350	13.8	4.4	10.3	42.0	1.7	3/4 Sq.	95	25.0
UW-251P	25	1	600 - 1,000	443 - 738	5,500	276	10.9	8.0	17.6	55.0	2.0	1 Sq.	95	28.0
UW-381	38	1-1/2	760 - 2,000	561 - 1,475	4,700	395	115.6	9.5	20.9	58.5	2.3	1 Sq.	100	31.5
UW-381L	38	1-1/2	1,400 - 2,000	1,033 - 1,475	4,700	543	21.4	10.0	20.9	58.5	2.3	1 Sq.	100	31.5
UW-381P	38	1-1/2	760 - 2,000	561 - 1,475	4,700	276	10.9	10.0	20.9	58.5	2.3	1 Sq.	99	31.5

Air Hose Size: 3/8" for UW-140P(WR) 1/2" I.D. for other models NOTE: Additional models available. Please contact AIMCO, 1-503-254-6600, or toll free 1-800-852-1368.  
Air Inlet: N.P.T. 1/4" for UW-140P(WR) N.P.T. 3/8" for UW-220P and UW-251P series N.P.T. 1/2" for UW-381 series



UW-550



UW-75S

## UW Series Twin Hammer Jumbo Impact Wrenches

Recommended Air Pressure: 85 psi

Model	Capacity		Torque Range (Approx)		Speed RPM	Overall Length		Weight		From Center to Outside		Sq. Dr. or Hex Size IN	Noise Level dB(A)	Average Air Consumption
	MM	IN	NM	FT-LB		MM	IN	KG	LB	MM	IN			
UW-550	55	2-1/4	2,500 - 5,800	1,844 - 4,278	3,500	525	20.7	36.0	79.0	78.0	3.1	1-1/2 Sq.	112	79.0
UW-75S	76	3	7,800 - 17,000	5,753 - 12,539	1,400	670	26.4	56.0	123.0	96.0	3.8	1-1/2 Sq.	112	114.0

Air Hose Size: 3/4" I.D. Air Inlet: N.P.T. 1" NOTE: Additional models available. Please contact AIMCO, 1-503-254-6600, or toll free 1-800-852-1368.

## UW Series Stud Bolt Wrenches

Recommended Air Pressure: 85 psi

Model	Capacity		Torque Range (Approx)		Speed RPM	Overall Length		Weight		From Center to Outside		Sq. Dr. or Hex Size IN	Noise Level dB(A)	Average Air Consumption
	MM	IN	NM	FT-LB		MM	IN	KG	LB	MM	IN			
UW-ST6SHK	8	5/16	22 - 49	16 - 36	6,500	170	6.7	1.7	3.7	24.0	1.0	3/8 Sq.	92	14.0

Air Hose Size: 3/8" I.D. Air Inlet: N.P.T. 1/4" NOTE: Additional models available. Please contact AIMCO, 1-503-254-6600, or toll free 1-800-852-1368.



UW-ST6SHK

# Grinders



UAG-40SBL-136



UAG-50SBL-109  
UAG-50SBL-120



UAG-70SBL-76



UAG-90SBL-59

## UAG Series Angle Grinders

Recommended Air Pressure: 85 psi

Model*	Capacity (Wheel Size)		Speed RPM	Rated Horsepower HP	Overall Length		Overall Height		Weight		Noise Level dB(A)	Average Air Consumption CFM
	IN	MM			IN	MM	IN	KG	LB			
UAG-40SBL-136	4		13,600	1.0	246	9.7	76	3.0	1.3	2.9	84	34.0
UAG-50SBL-109	5		10,900	1.0	246	9.7	76	3.0	1.4	3.1	82	34.0
UAG-50SBL-120	5		12,000	1.0	246	9.7	76	3.0	1.4	3.1	82	34.0
UAG-70SBL-76	7		7,600	2.0	300	11.8	98	3.9	2.9	6.4	83	57.0
UAG-90SBL-59	9		5,900	2.5	308	12.1	98	3.9	3.3	7.3	88	67.0



UG-25NA



UG-38N



UG-38NA



UG-38NL



UG-38NS



UG-50S-200



UG-45H

UG-60S-29

## UG Series Die Grinders

Recommended Air Pressure: 85 psi

Model*	Collet Chuck Size		Speed RPM	Rated Horsepower HP	Overall Length		Weight		Noise Level dB(A)	Average Air Consumption CFM
	IN	MM			IN	MM	KG	LB		
UG-25NA	1/4		23,500	0.3	153	6.0	0.5	1.2	82	10.7
UG-38N	1/4		25,000	0.4	164	6.5	0.6	1.3	85	10.7
UG-38NA	1/4		22,000	0.4	165	6.5	0.7	1.4	75	14.0
UG-38NL	1/4		21,000	0.4	317	12.5	0.9	2.0	85	10.7
UG-38NS	1/4		25,000	0.4	174	6.8	0.6	1.3	85	10.7
UG-50S-200	1/4		23,000	0.3	198	7.8	0.6	1.3	73	14.0
UG-45H	1/4		18,000	0.5	196	7.7	0.8	1.8	76	22.0
UG-60S-29*	1/4		2,900	0.5	227	8.9	1.1	2.3	77	18.0

\*UG-60S-29 includes spanner wrench to tighten collet

## UG Series Mini Angle Die Grinders

Recommended Air Pressure: 85 psi

Model*	Collet Chuck Size		Speed RPM	Rated Horsepower HP	Overall Length		Overall Height		Weight		Noise Level dB(A)	Average Air Consumption CFM
	IN	MM			IN	MM	KG	LB				
UG-20A-200	1/4		20,000	0.2	131	5.2	80	3.2	0.5	1.1	75	10.7
UG-20A-120	1/4		12,000	0.2	131	5.2	80	3.2	0.5	1.1	76	10.7
UG-50S-200A	1/4		20,000	0.3	195	7.7	87	3.4	0.9	2.0	75	14.0



UG-20A-120  
UG-20A-200



UG-50S-200A



UG-65EB



UG-65EBL



UG-650EL

## UG Series Lightweight Grinders

Recommended Air Pressure: 85 psi

Model*	Capacity (Wheel Size)		Speed RPM	Rated Horsepower HP	Overall Length		Weight		Noise Level dB(A)	Average Air Consumption CFM
	IN	MM			IN	MM	KG	LB		
UG-65EB	2.5		14,600	0.6	242	9.8	1.3	2.8	95	22.0
UG-65EBL	2.5		14,600	0.6	272	10.7	1.4	3.1	95	22.0
UG-650EL	2.5		14,600	0.6	420	16.5	1.6	3.4	85	22.0

## UG Series Horizontal Grinder

Recommended Air Pressure: 85 psi

Model	Capacity (Wheel Size)		Speed RPM	Rated Horsepower HP	Overall Length		Weight		Noise Level dB(A)	Average Air Consumption CFM
	IN	MM			IN	MM	KG	LB		
UG-1250L-72	5		7,200	1.0	436	17.2	2.8	6.2	88	32.7



UG-1250L-72

\*Air Hose Size: 3/8" I.D. - 1/2" I.D. (UG-1250L-72)

Air Inlet: N.P.T. 1/4" - N.P.T. 3/8" (UAG-90SBL-59 and UG-1250L-72)

NOTE: Additional models available. Please contact AIMCO, 1-503-254-6600, or toll free 1-800-852-1368.



# Sanders and Drills

## UP Series Sander

Recommended Air Pressure: 85 psi

Model	Capacity (Wheel Size)		Speed RPM	Rated Horsepower HP	Overall Length		Weight		Noise Level dB(A)	Average Air Consumption CFM
	IN	MM			IN	MM	KG	LB		
UP-25DB	5		10,000	0.3	212	8.3	1.7	3.7	73	7.0

Air Hose Size: 3/8" I.D. Air Inlet: N.P.T. 1/4" NOTE: Additional models available. Please contact AIMCO, 1-503-254-6600, or toll free 1-800-852-1368.



## UD Series Drills

Recommended Air Pressure: 85 psi

Model	Capacity		Speed RPM	Overall Length		Weight With Chuck		From Center To Outside		Nominal Chuck Size IN	Type of Spindle IN-THR'D	Noise Level dB(A)	Average Air Consumption CFM
	MM	IN		MM	IN	KG	LB	MM	IN				
Pistol													
UD-50-200	3	1/8	23,000	135	5.3	0.7	1.5	21.0	0.8	5/16	3/8-24UNF	73	14
UD-50-45	6	1/4	5,000	145	5.7	0.9	1.9	21.0	0.8	5/16	3/8-24UNF	72	14
UD-50-22	8	5/16	2,200	140	5.5	0.9	2.0	21.0	0.8	5/16	3/8-24UNF	72	14
UD-60-29	8	5/16	2,900	167	6.6	1.1	2.4	22.5	0.9	5/16	3/8-24UNF	77	18
UD-60-20	8	5/16	2,000	180	7.1	1.2	2.6	22.5	0.9	5/16	3/8-24UNF	77	18
UD-60-15	8	5/16	1,600	180	7.1	1.2	2.6	22.5	0.9	5/16	3/8-24UNF	76	18
UD-60-07	13	1/2	700	219	8.6	1.4	3.1	22.5	0.9	1/2	1/2-20UNF	75	18
UD-60-04	13	1/2	500	220	8.6	1.4	3.1	22.5	0.9	1/2	1/2-20UNF	75	18
UD-80-12	13	1/2	1,200	216	8.5	1.8	4.0	26.0	1.0	1/2	1/2-20UNF	79	23
UD-80-07	13	1/2	700	239	9.4	2.3	5.1	26.0	1.0	1/2	1/2-20UNF	79	23
UD-80-04	16	5/8	400	247	9.7	2.9	6.4	26.0	1.0	5/8	5/8-16UNF	79	23
Inline													
UD-50S-45	6	1/4	5,000	210	8.3	0.9	1.9	21.0	0.8	5/16	3/8-24UNF	77	14
UD-50S-22	8	5/16	2,200	205	8.1	0.8	1.8	21.0	0.8	5/16	3/8-24UNF	77	14
UD-60S-29	8	5/16	2,900	227	8.9	1.1	2.3	22.5	0.9	5/16	3/8-24UNF	77	18
UD-60S-15	8	5/16	1,600	238	9.4	1.2	2.5	22.5	0.9	5/16	3/8-24UNF	77	18
Angle													
UD-50S-45A	4	#8	5,000	253	10	0.9	1.98	21.0	0.8	-	1/4-28UNF	79	14
UD-50S-45A*	4	#8	5,000	253	10	0.9	1.98	21.0	0.8	-	1/4-28UNF	79	14
UD-60S-29C	8	5/16	2,900	276	10.9	1.5	3.3	22.5	0.9	5/16	3/8-24UNF	79	18
UD-60S-15C	8	5/16	1,600	283	11.1	1.6	3.5	22.5	0.9	5/16	3/8-24UNF	79	18

\* UD-50S-45A\* comes with a cone jaw chuck installed.

Air Hose Size: 3/8" I.D.

Air Inlet: N.P.T. 1/4"

NOTE: Other models are available. Please contact AIMCO, 1-503-254-6600, or toll free 1-800-852-1368.

# Percussion Tools

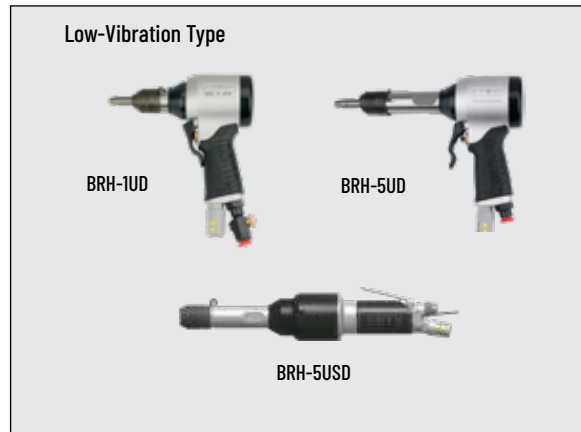
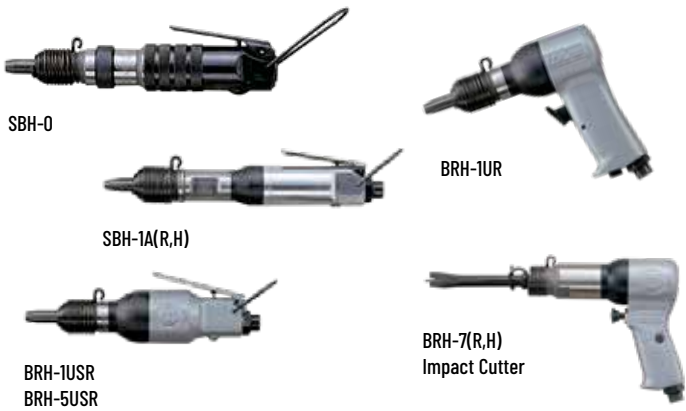

## SBH / BRH Series Riveting Hammers Impact Cutter

Recommended Air Pressure: 85 psi

Model	Capacity		Blow Per Min. BPM	Overall Length		Weight		Piston Diameter		Piston Stroke		Noise Level dB(A)	Average Air Consumption CFM
	Duralumin IN	Steel IN		MM	IN	KG	LB	MM	IN	MM	IN		
<b>Standard Type</b>													
SBH-0	#2	—	6,500	123	4.8	0.3	0.7	10.0	0.4	23	0.9	90	3.5
SBH-1A(R,H)*	#3	—	4,000	209	8.2	0.9	1.9	11.1	0.4	56	2.2	92	5.0
BRH-1UR	#5	#3	2,800	122	4.9	1.1	2.4	14.3	0.6	38	1.5	95	12.0
BRH-1USR	#5	#3	2,800	180	7.1	1.0	2.2	14.3	0.6	38	1.5	95	12.0
BRH-5USR	1/4	#10	1,800	246	9.7	1.5	3.2	12.7	0.5	100	4.0	95	13.0
<b>Low-Vibration Type</b>													
BRH-1UD(R)*	#5	#3	2,800	122	4.9	1.1	2.4	14.3	0.6	38	1.5	95	12.0
BRH-5UD(R)*	1/4	#10	1,800	189	7.4	1.4	3.1	12.7	0.5	100	4.0	95	13.0
BRH-5USD	1/4	#10	2,800	211	10.7	1.7	3.6	12.7	0.6	100	1.5	95	12.0
<b>Impact Cutter</b>													
BRH-7(R,H)*	—	—	3,400	168	6.6	1.6	3.6	19.1	0.8	50	2.0	100	17.0

Air Hose Size: 3/8" I.D. Air Inlet: N.P.T. 1/4" \* R - Round Bushing H - Hex Bushing



## CB / RH Series One Shot Hammers

Recommended Air Pressure: 85 psi

Model	Blow Power LB	Rivet Set Dia x Length IN	Shank Diameter		Stroke		Length		Weight	
			MM	IN	MM	IN	MM	IN	LB	KG
3wW34	20.4	—	10.2	0.401	29.8	1.2	213	8.4	2.0	0.9
RH-80	27.6	—	10.2	0.401	29.8	1.2	254	10.0	2.9	0.3
RH-90	103	—	10.2	0.401	29.8	1.2	328	12.9	3.5	1.6
RH-100Z	78.1	—	10.2	0.401	29.8	1.2	328	12.9	3.9	1.8
RH-200	139	—	10.2	0.401	39.8	1.2	341	13.4	4.6	2.1

Air Hose Size: 3/8" I.D. Air Inlet: N.P.T. 1/4" NOTE: Additional models available. Please contact AIMCO, 1-503-254-6600, or toll free 1-800-852-1368.

# Air Preparation Units

## AFRL STACKING FILTER/REGULATORS

Stacking filter/regulator combinations provide air filtration and precise regulation in a single unit for easy mounting and installation.

### FEATURES AND BENEFITS

- All models include L-mount bracket, gauge, and metal bowl shields
- Polycarbonate filter and lubricator bowls (metal bowls standard on AFRL-8)
- 25-micron filter included on all models
- Regulating range: 7 - 125 PSI
- Custom order upgrade items include metal bowl, 5 micron filter, semi-automatic filter drain, and reduced PSI range regulator. Contact an AIMCO Customer Service Associate for more information, 1-503-254-6600, or toll free 1-800-852-1368
- Maximum allowable Input Pressure not to exceed 120 PSI



AFRL-2-C  
AFRL-3-C

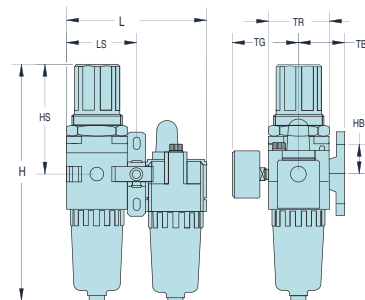

AFRL-3  
AFRL-4  
AFRL-8

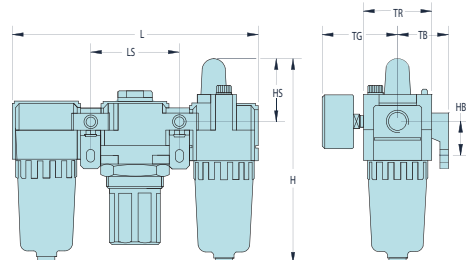

28178  
HT Air Tool/AFRL  
Carrying Kit



AFRL-4HTA  
Standalone Unit

### AFRL Stacking Filter/Regulators

Model	Port	Gauge Port	Flow Rate CFM	Flow Rate L/MIN	Bowl Shield	H IN/MM	HB IN/MM	HS IN/MM	L IN/MM	LS IN/MM	TB IN/MM	TG IN/MM	TR IN/MM
AFRL-2	1/4"	1/8"	70	2,000	yes	6.16 (156.5)	1.39 (35.3)	1.50 (38.1)	7.13 (181.1)	2.52 (64.0)	1.61 (41.0)	2.39 (60.7)	2.09 (53.1)
AFRL-2-C	1/4"	1/8"	60	1,700	yes	8.31 (211.1)	1.38 (35.1)	3.64 (92.5)	4.61 (117.1)	2.30 (58.4)	1.61 (40.9)	2.39 (60.7)	2.09 (53.1)
AFRL-3	3/8"	1/4"	140	4,000	yes	7.54 (191.5)	1.57 (40.0)	1.61 (40.9)	9.37 (238.0)	3.31 (84.1)	1.97 (50.0)	2.58 (65.5)	2.76 (70.1)
AFRL-3-C	3/8"	1/4"	105	3,000	yes	10.31 (261.9)	1.57 (39.9)	4.41 (112.0)	6.06 (153.9)	3.03 (77.0)	1.97 (50.0)	2.58 (65.5)	2.76 (70.1)
AFRL-4	1/2"	1/4"	140	4,000	yes	7.54 (191.5)	1.57 (40.0)	1.61 (40.9)	9.37 (238.0)	3.31 (84.1)	1.97 (50.0)	2.58 (65.5)	2.76 (70.1)
AFRL-8	1"	1/4"	180	5,000	yes	10.69 (271.5)	1.97 (50.0)	1.89 (48.0)	11.81 (300.0)	4.13 (104.9)	2.75 (69.9)	2.97 (75.4)	3.54 (89.9)

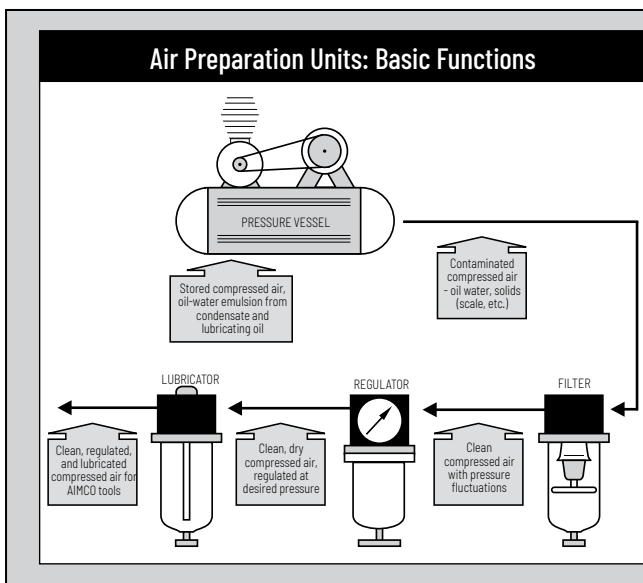

The supply of clean, dry air is essential to the operation of pneumatic powered tools. Use only clean filtered air for longer tool life. Provide proper airflow (CFM) and regulate air pressure (PSI) for optimum performance.

To determine unit size for application, you need to know:

- Total air flow (CFM) required for application
- Size of incoming air line and size of air line required by tool
- Air supply pressure (PSI)
- Allowable pressure drop
- Does the application require lubrication?
- Does the overall system have the required capacity?

# Air Line

## Polyurethane Hose



- Durable Polyurethane is chemical resistant and lightweight, and provides excellent recoil memory and maximum flexibility
- Available in transparent hose color (opaque also available)
- Assemblies for coiled hose include reusable swivel fitting. Straight hose available with or without fittings
- Working temperature:  $-104^{\circ}\text{F}$  to  $175^{\circ}\text{F}$

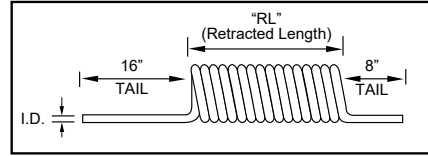

## Single Air Hose Assemblies (Coiled)

Model	Description (O.D. x I.D. x Length)	Retracted Length	Working Pressure	Npt Fittings
ASH-250C-10MSZ	3/8" x 1/4" x 10'	7"	100 psi	1/4"
ASH-250C-15MSZ	3/8" x 1/4" x 15'	9-1/2"	100 psi	1/4"
ASH-250C-25MSZ	3/8" x 1/4" x 25'	15-1/2"	100 psi	1/4"
ASH-375C-15MSZ	9/16" x 3/8" x 15'	10"	100 psi	3/8"
ASH-375C-25MSZ	9/16" x 3/8" x 25'	14"	100 psi	3/8"
ASH-500C-15MSZ	3/4" x 1/2" x 15'	13"	100 psi	1/2"
ASH-500C-25MSZ	3/4" x 1/2" x 25'	23"	100 psi	1/2"

Custom length coil assemblies and special colors available in minimum order quantities. Contact an AIMCO Customer Service Associate, 1-503-254-6600, or toll free 1-800-852-1368.



## Straight Air Hose (Sold Per Foot)

Model	Description
ASH-375Z	3/8" I.D.
ASH-500Z	1/2" I.D.

Contact an AIMCO Customer Service Associate about full reel pricing, 1-503-254-6600, or toll free 1-800-852-1368.

## Rubber Hose



- Designed for use in a wide range of industrial, construction, and agricultural applications
- Constructed of high grade, reinforced EPDM synthetic rubber
- Working temperature:  $-40^{\circ}\text{F}$  to  $190^{\circ}\text{F}$

## Single Air Hose (Rubber)

I.D.	O.D.	Length	Working Pressure	Weight
3/16"	0.44"	10 ft	200 psi	0.8 lb
1/4"	0.5"	10 ft	200 psi	0.9 lb
5/16"	0.58"	10 ft	200 psi	1.2 lb
3/8"	0.67"	10 ft	200 psi	1.5 lb
1/2"	0.81"	10 ft	200 psi	2.0 lb
5/8"	0.97"	10 ft	200 psi	2.7 lb
3/4"	1.12"	10 ft	200 psi	3.4 lb

Custom lengths available. Contact an AIMCO Customer Service Associate for more details, 1-503-254-6600, or toll free 1-800-852-1368.

## Helpful Hints For Air Hose Use

- Use recommended I.D. air hose and fittings
- Replace air hose regularly to help maintain clean air
- A clear hose allows you to see water or dirt accumulation in hose
- Use correct length of hose to reduce air loss and pressure drop
- Use locking quick-disconnect couplers for additional safety

# Air Line Accessories

## BRASS QUICK COUPLERS

Manual ball couplers designed for use with ergonomic twist plugs. Brass with nitrile seals, rated to 300 PSI, from -40° to +250° F.



Model	Description
B23	1/4" NPT F x 1/4" QC Brass Coupler
B23E	1/4" NPT F x 3/8" QC Brass Coupler
B25	3/8" NPT F x 3/8" QC Brass Coupler

## IN-LINE MINI REGULATORS

Easily adjust airflow with the turn of a dial.



Model	Capacity
932-100-0	1/8" NPT
932-110-0A	1/4" NPT

## MINI AIR GAUGE SWIVEL JOINT KITS

- Bi-directional 360° rotation
- Keeps air hose straight and untwisted
- Decreases operator fatigue



Model	Inlet	Weight	Max Psi	Tool CFM
7021AG	1/4" NPT	3 oz	Up to 125	25
7041AG	3/8" NPT	3 oz	Up to 125	50



7021AG

## SWIVEL AIR FITTINGS

For use with most portable air tools, including grinders, drills, screwdrivers, buffers, sanders, staple guns, and more. Rotates 360° for awkward angles.

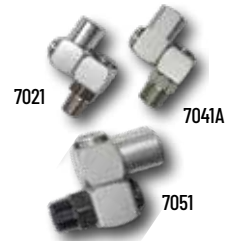

Model	Inlet	Weight	Max PSI	Tool CFM
7021	1/4" NPT	3 oz	Up to 125	25
7041A	3/8" NPT	11 oz	Up to 125	50
7051	1/2" NPT	7 oz	Up to 125	60

## AIR LINE FITTINGS

Model	Capacity
250-RZ	1/4" NPT Rigid Fitting
250-SZ	1/4" NPT Swivel Fitting
375-RZ	3/8" NPT Rigid Fitting
375-SZ	3/8" NPT Swivel Fitting
500-SZ	1/2" NPT Swivel Fitting



## BRASS ADAPTERS AND BUSHINGS

Pipe fittings for use as medium and low pressure connectors. Meets functional requirements of SAE J530, SAE J531, ASME and ASA. Rated 1,000 PSI from -65° to +250° F.



Model	Description
222P-6-4	3/8" NPT F x 1/4" NPT M Adapter
222P-8-6	1/2" NPT F x 3/8" NPT M Adapter
222P-12-8	3/4" NPT F x 1/2" NPT M Adapter
209P-6-4	1/4" NPT F x 3/8" NPT M Bushing
209P-8-6	3/8" NPT F x 1/2" NPT M Bushing

## ERGONOMIC TWIST PLUGS

These unique, ergonomically designed hose fittings provide 360° rotation and 35° angled rotation in any direction.

- Two rotation points prevent kinking of air hose
- Design ensures full air pressure flow
- Rotating joint comes with polyurethane dust cover
- Heavy duty construction



TS-30NP-2NPT



TS-20NP-2NPT



TS-20US-2NPT



TS-30US-3NPT

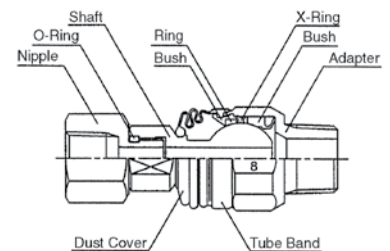

Model	Description
TS-30NP-2NPT	3/8" NPT Female x 1/4" NPT Male
TS-20NP-2NPT	1/4" NPT Female x 1/4" NPT Male
TS-20US-2NPT	1/4" US Plug x 1/4" NPT Male
TS-30US-3NPT	3/8" US Plug x 3/8" NPT Male

# Index

MODEL #	PAGE	MODEL #	PAGE	MODEL #	PAGE	MODEL #	PAGE	MODEL #	PAGE
<b>A</b>		<b>E</b>		<b>R</b>		<b>S</b>		<b>Numbers</b>	
AAP1866400A	4	EY0L82B	14, 16	RH-25	34	SBH-0	34	209P-6-4	37
AAP1866600A	4	EYFB32	14	RH-80	34	SBH-1A(R,H)	34	209P-8-6	37
AAP1866850A	4	EYFB41	14, 16	RH-90	34	SIW-38PR	24	222P-6-4	37
AAP1876950A	4			RH-100Z	34	SIW-50PR	24	222P-8-6	37
AAP18771350A	4			RH-200	34	SIW-B20LI	24	222P-12-8	37
AAP18772000A	4					SIW-B20LI-HC	24	250-RZ	37
AAP18772950A	4					SIW-C18-20	24	250-SZ	37
AAP18885100A	4					SIW-P2525Q	24	21226	26
AAP2B76250A(R)	5					SIW-P3225Q	24	27768	6
AAP2B76450A(R)	5					SIW-P3238	24	27769	6
AAP2B76650A(R)	5					SIW-P5538	24	27771	6
AAP2B76950A(R)	5					SIW-P5550	24	28161	6
AAP2B771400A(R)	5					SIW-P10050	24	28162	6
AAP2B772000A(R)	5					SIW-P12050	24	28163	6
AAP2B773000A(R)	5					SIW-PBL	24	28164	6
AAP2B785100A(R)	5					SPC-2PGM	26	28178	4, 35
AE-224PS	29					SPC-A21025	25	28796	6, 36
AE-278PS	29					SPC-A21025Q	25	375-RZ	37
AE-2015	28					SPC-A21038	25	375-SZ	37
AE-2020	27					SPC-A21625	25	4H2055	29
AE-2045A	29					SPC-A21625Q	25	500-SZ	6, 37
AE-4020	29					SPC-A21638	25	7021	37
AE-4520	27					SPC-A23038	25	7021AG	37
AE-4520ESD	27					SPC-A23538	25	7041A	37
AE-5681	27					SPC-A25038	25	7041AG	37
AE-5681ESD	27					SPC-A27038	25	7051	37
AE-6300	28					SPC-A210050	25	878-845-1	12
AE-6300M	28					SPC-B218LI	26	910-831-0	12
AE-6300S	28					SPC-B218LI-HC	26	910-832-0	12
AE-6450	28					SPC-C218-19	26	932-100-0	37
AE-6450S	28					SPC-P2325Q	25	932-110-0A	37
AE-7010	27					SPC-P2625Q	25	976-379-0	22
AE-7010PS	27					SPC-P2925Q	25	976-430-0	22
AE-7080A	29					SPC-P21225Q	25	976-431-0	22
AE-8010	27					SPC-QC	26	976-432-0	22
AE-8010PS	27							976-471-0	22
AE-8681	27							976-472-0	22
AE-PG7080	29							976-493-0	22
AE-TC040	29							976-504-0	22
AE-TC7080	29							976-515-0	22
AFRL-4	4, 35							976-516-0	22
AFRL-4HTA	4, 35							976-517-0	22
AFRL-2	35							976-588-0	22
AFRL-2-C	35							976-614-0	22
AFRL-3	35							976-620-0	22
AFRL-3-C	35							10C-840-1	14
AFRL-8	35							10E-840-1	14
AM-45	29								
AM-65	29								
APM-30	29								
ASH-250C-10MSZ	36								
ASH-250C-15MSZ	36								
ASH-250C-25MSZ	36								
ASH-375C-15MSZ	36								
ASH-375C-25MSZ	36								
ASH-375Z	36								
ASH-500C-15MSZ	6, 36								
ASH-500C-25MSZ	6, 36								
ASH-500Z	6, 36								
ATM-800	19								
ATM-1800	19								
ATM-2800	19								
ATM-3800	19								
ATM-5000	19								
ATM-8000	19								
ATM-12000	19								
ATM-16000	19								
<b>B</b>									
B23	37								
B23E	37								
B25	37								
B25	37								
BJ10082	26								
BJ10083	26								
BJ10091	24								
BP-T40-(B) (KIT)	13								
BP-T40-RF8 (B) (KIT)	14								
BP-T40D-(B) (KIT)	13								
BP-T40D-RF8 (B) (KIT)	14								
BP-T50-(B) (KIT)	13								
BP-T50-RF8 (B) (KIT)	14								
BP-T50D-(B) (KIT)	13								
BP-T50D-RF8 (B) (KIT)	14								
BP-T60-(B) (KIT)	13								
BP-T60-RF8 (B) (KIT)	14								
BP-T60D-(B) (KIT)	13								
BP-T60D-RF8 (B) (KIT)	14								
BRH-1UD(R)	34								
BRH-1UR	34								
BRH-1USR	34								
BRH-5UD(R)	34								
BRH-5USD	34								
BRH-5USR	34								
BRH-7(R,H)	34								
UAT-70SL	8								
UAT-80	8								
UAT-90	8								
UAT-90L	8								
UAT-100	8								
UAT-100L	8								
UAT-130	8								
UAT-150	8								
UAT-180	8								
UAT-200	8								
UAT-200L	8								
UBX-T70	16								
UD-50-22	33								
UD-50-45	33								
UD-50-200	33								
UD-50S-22	33								
UD-50S-45	33								
UD-50S-45A	33								
UD-50S-45A*	33								
UD-60-04	33								
UD-60-07	33								
UD-60-15	33								
UD-60-20	33								
UD-60-29	33								
UD-60S-15	33								
UD-60S-15C	33								
UD-60S-29	33								
UD-60S-29C	33								
UD-80-04	33								
UD-80-07	33								
UD-80-12	33								
UG-20A-120	25								
UG-20A-200	32								
UG-25NA	32								
UG-38N	32								
UG-38NA	32								
UG-38NL	32								
UG-38NS	32								
UG-45H	32								
UG-50S-200	32								
UG-50S-200A	32								
UG-60S-29	32								
UG-65EB	32								
UG-65BEL	32								
UG-1250L-72	32								
UGW-6N	18								
UGW-8N	18								
UL-30	9								
UL-30D	9								
UL-30S	9								
UL-30SD	9								
UL-40	9								
UL-40D	9								
UL-40S	9								
UL-40SD	9								
UL-50	9								
UL-50D	9								
UL-50S	9								
UL-50SD	9								
UL-60	9								
UL-60D	9								
UL-60S	9								
UL-60SD	9								
UL-70	9								
UL-70S	9								
UL-80	9								
UL-90	9								
UL-100	9								
UL-130	9								
UL-150	9								
ULT-40C	10								





PRINTED IN THE U.S.A.

LIT-AT110, REV 02-25-22, ©2022 AIMCO

AIMCO CORPORATE HEADQUARTERS

10000 SE Pine Street  
Portland, Oregon 97216  
Phone: (503) 254-6600  
Toll Free: 1-800-852-1368

AIMCO CORPORATION DE MEXICO SA DE CV

Ave. Cristobal Colon 14529  
Chihuahua, Chihuahua. 31125  
Phone: (01-614) 380-1010  
Fax: (01-614) 380-1019