

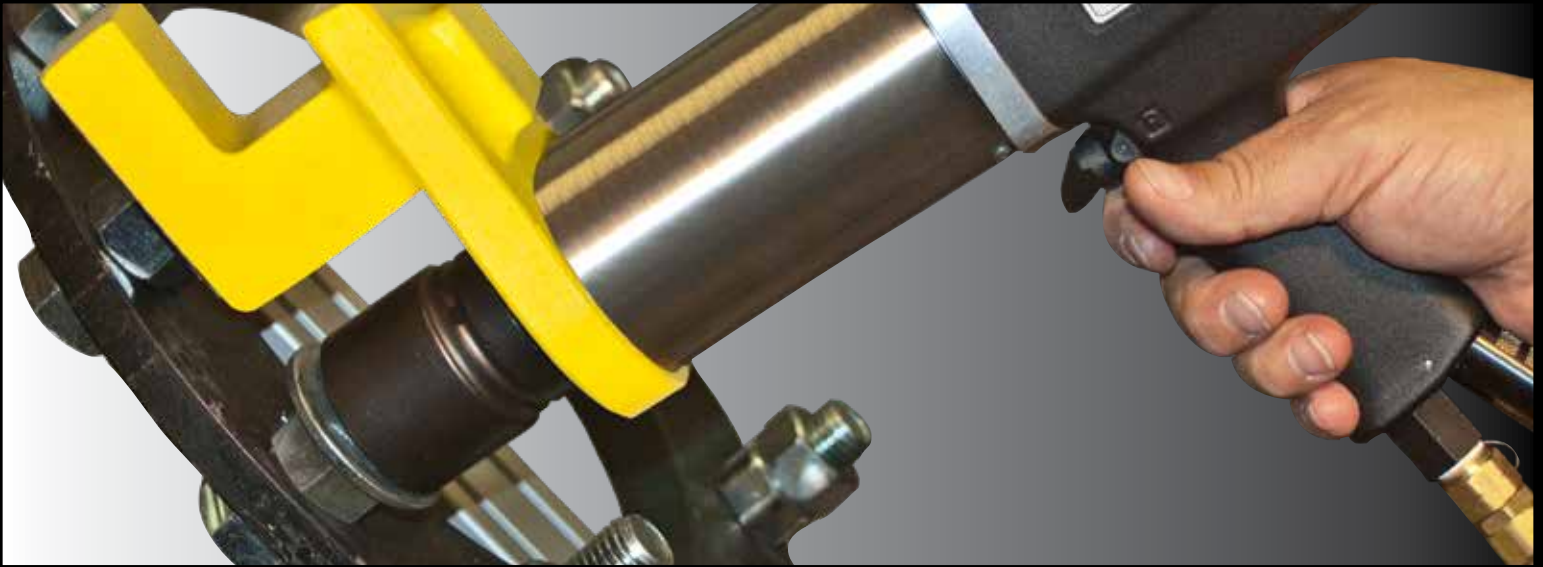

HIGH TORQUE PNEUMATIC TOOLS





For more than 50 years, AIMCO has been working with manufacturers around the world. We are the complete global source for all critical fastening and bolting solutions. AIMCO can effectively and swiftly meet your needs whether you're in Tennessee, USA fastening a 3 mm nut at 3 Nm, or in Denmark servicing wind-turbine bolts at 17,000 Nm. AIMCO provides the tools and solutions, on a global scale, that guarantee the success of your project. It is with great pride that AIMCO can say the products that we manufacture are **MADE IN THE USA.**

AcraDyne High Torque Pneumatic Tools

FEATURES AND BENEFITS

AcraDyne's High Torque Pneumatic Bolting Tools offer a reliable and dependable solution for the installation and removal of heavy-duty fasteners. Appropriate for use in industries requiring high torque capability, accuracy, power, and safety.

- Modular design allows for ease of maintenance
- Interchangeable motors and gearing
- Same proven and reliable gearbox as the AcraDyne DC line
- One-hand reverse



AAP1B66600A



AAP1B76950A



AAP1B772000A



AAP1B885100A



AAP1B Series Tools

Model	Torque (NM)	Torque (FT-LB)	Speed (RPM)	Weight (LB)	Square Dr. (IN)	Air Consumption (CFM)
AAP1B66400A	400	300	57	9.75	3/4	22.9
AAP1B66600A	600	450	39	9.75	3/4	22.9
AAP1B66850A	850	625	27	9.75	3/4	22.9
AAP1B76950A	950	700	31	10.4	3/4	26.3
AAP1B771350A	1,350	1,000	22	10.4	1	26.3
AAP1B772000A	2,000	1,475	14	12.7	1	26.3
AAP1B772950A	2,950	2,175	9	14.9	1	26.3
AAP1B885100A	5,100	3,775	8	23	1-1/2	31.5

AIR PREPARATION UNITS

Many stacking filter/regulator combinations are available. See page 7 for options.



AFRL-4



AFRL-4HTA Standalone Unit

28178 HT Air Tool/AFRL Carrying Kit



Maximum allowable Input Pressure not to exceed 120 PSI.

AcraDyne High Torque, High Speed Pneumatic Tools

Our High-Torque, High-Speed Pneumatic Bolting Tools offer a reliable and dependable solution for the installation and removal of heavy-duty fasteners with high torque capability, accuracy, power, and safety.

FEATURES AND BENEFITS

- Dual motor design provides extremely fast rundown speed
- Improved torque to weight ratio
- Full swivel gearcase facilitates reaction bar positioning for ease of use and operator comfort
- Handle exhaust with low sound level
- Uses the same durable and reliable gearbox from our DC line of high torque tools
- Modular design allows for easy maintenance
- Two-piece handle construction enables flexible handle design
- Available in reversible and non-reversible models



AAP2B Series Tools

Model	Torque		Speed (RPM)	Weight		Length		Square Dr. (IN)
	(NM)	(FT-LB)		(LB)	(KG)	(IN)	(MM)	
AAP2B76250A	250	185	660	10.5	4.8	10	255	3/4
AAP2B76450A	450	330	335	10.5	4.8	10	255	3/4
AAP2B76650A	650	480	223	10.5	4.8	10	255	3/4
AAP2B76950A	950	700	153	10.5	4.8	10	255	3/4
AAP2B771400A	1,400	1,000	110	14.6	6.6	10	255	1
AAP2B772000A	2,000	1,475	63	14.8	6.7	11.2	284	1
AAP2B773000A	3,000	2,210	52	15.0	6.8	11.6	293	1
AAP2B785100A	4,800	3,540	26.5	19.7	8.9	13.3	338	1.5

AAP2B Series Reversible Tools

Reversible Model	Torque		Speed (RPM)	Weight		Length		Square Dr. (IN)
	(NM)	(FT-LB)		(LB)	(KG)	(IN)	(MM)	
AAP2B76250AR	250	185	660	12.3	5.6	12.5	317	3/4
AAP2B76450AR	450	330	335	12.3	5.6	12.5	317	3/4
AAP2B76650AR	650	480	223	12.3	5.6	12.5	317	3/4
AAP2B76950AR	950	700	153	12.3	5.6	12.5	317	3/4
AAP2B771400AR	1,400	1,000	110	16.4	7.4	12.6	319	1
AAP2B772000AR	2,000	1,475	63	16.6	7.5	13.6	346	1
AAP2B773000AR	3,000	2,210	52	16.8	7.6	14.0	356	1
AAP2B785100AR	4,800	3,540	26.5	21.5	9.7	15.8	400	1.5

DynaTorque Manual Torque Multipliers

DynaTorque



FEATURES AND BENEFITS

Manual Torque Multipliers offer the perfect, economical solution to high torque bolting applications.

- Superior power to weight ratio
- Delivered torque accuracy +/- 4%
- Anti-Wind Up safety feature (2,800 NM models and up) prevents input device from springing backward when released
- True torque multiplication ratios
- Standard reaction arms supplied. Custom reaction arms/nose extensions available to suit specific applications
- No preventative maintenance required
- Overload protected by shear-drive design (spare torsion shaft included). Easily replace sheared-off pins at the work site

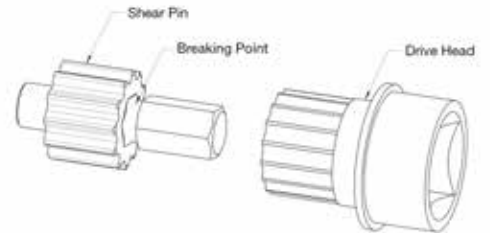

DynaTorque Manual Torque Multipliers

Model	Input IN	Output IN	Ratio	Max Torque Output		A (MM)	B (MM)	C (MM)	D (MM)	Weight*	
				Nm	Ft-Lb					LB	KG
ATM-800	1/2	3/4	1:3.5	800	590	65	105	132	130	2.9	1.3
ATM-1800	3/4	1	1:3.6	1,800	1,327	90	150	188	132	6.6	3.0
ATM-2800	1/2	1	1:13	2,800	2,066	95	200	240	132	11.5	5.2
ATM-3800	3/4	1	1:13	3,800	2,804	95	200	240	132	11.5	5.2
ATM-5000	3/4	1.5	1:17	5,000	3,690	120	215	272	150	15.4	7.0
ATM-8000	3/4	1.5	1:49	8,000	5,904	132	268	344	200	25.4	11.5
ATM-12000	3/4	1.5	1:58	12,000	8,856	156	272	348	200	30.9	14.0
ATM-16000	3/4	2.5	1:75	16,000	11,808	215	292	370	225	57.3	26.0

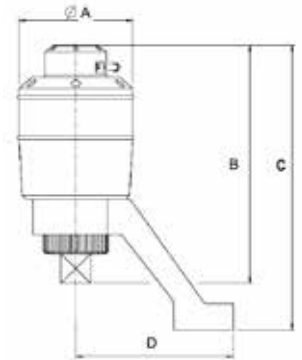

* Weight shown does not include weight of reaction device.



CARRYING CASE

All DynaTorque Multipliers are supplied in a rugged, weather-resistant, portable carrying case.



AcraDyne HT Pneumatic Tool Accessories

Polyurethane Hose for HT Tools



- Durable Polyurethane is chemical resistant and lightweight, and provides excellent recoil memory and maximum flexibility
- Available in transparent hose color (opaque also available)
- Assemblies for coiled hose include reusable swivel fitting. Straight hose available with or without fittings
- Working temperature: -104° F to 175° F
- Working pressure: 100 PSI

Single Air Hose Assemblies (Coiled)

Model	Description (O.D. x I.D. x Length)	Retracted Length	Npt Fittings
ASH-500C-15MSZ	3/4" x 1/2" x 15'	13"	1/2"
ASH-500C-25MSZ	3/4" x 1/2" x 25'	23"	1/2"



Straight Air Hose (Sold Per Foot)

MODEL	DESCRIPTION
ASH-500Z	1/2" I.D.

Contact an AIMCO Customer Service Associate about full reel pricing, 1-503-254-6600, or toll free 1-800-852-1368.

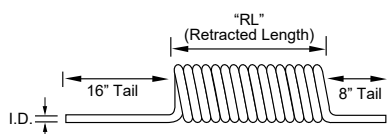

Custom length coil assemblies and special colors available in minimum order quantities. Contact an AIMCO Customer Service Associate, 1-503-254-6600, or toll free 1-800-852-1368.

Rubber Hose for HT Tools



- Designed for use in a wide range of industrial, construction, and agricultural applications
- Constructed of high grade, reinforced EPDM synthetic rubber
- Working temperature: -40° F to 190° F

Single Air Hose (Rubber)

I.D.	O.D.	Length	Working Pressure	Weight
1/2"	0.81"	10 ft	200 psi	2.0 lb
5/8"	0.97"	10 ft	200 psi	2.7 lb
3/4"	1.12"	10 ft	200 psi	3.4 lb

Custom lengths available. Contact an AIMCO Customer Service Associate for more details, 1-503-254-6600, or toll free 1-800-852-1368.

REACTION BARS

Tool includes standard, spline attachment reaction device. Custom reaction devices are available; contact an AIMCO Customer Service Associate for more details, 1-503-254-6600, or toll free 1-800-852-1368.



Air Line Fittings



Plugs

Model	Description
28161	1/2" x 1/4" MPT
28162	1/2" x 3/8" MPT
28163	1/2" x 1/2" MPT
28164	1/2" x 1/2" FPT

Quick-Change Couplers

Model	Description
27768	1/2" FPT
27769	1/2" MPT



Protective Coupler

Model	Description
27771	Vinyl



Swivel Fitting

Model	Capacity
500-SZ	1/2" NPT Swivel Fitting

Air Preparation Units

AFRL STACKING FILTER/REGULATORS

Stacking filter/regulator combinations provide air filtration and precise regulation in a single unit for easy mounting and installation.

FEATURES AND BENEFITS

- All models include L-mount bracket, gauge, and metal bowl shields
- Polycarbonate filter and lubricator bowls (metal bowls standard on AFRL-8)
- 25-micron filter included on all models
- Regulating range: 7 - 125 PSI
- Custom order upgrade items include metal bowl, 5 micron filter, semi-automatic filter drain, and reduced PSI range regulator. Contact an AIMCO Customer Service Associate for more information, 1-503-254-6600, or toll free 1-800-852-1368
- Maximum allowable Input Pressure not to exceed 120 PSI



AFRL-2-C
AFRL-3-C

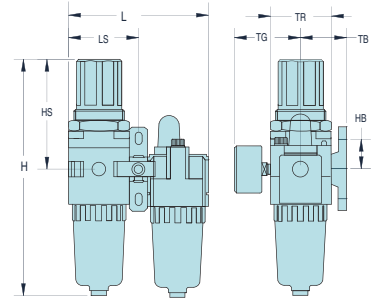

AFRL-3
AFRL-4
AFRL-8

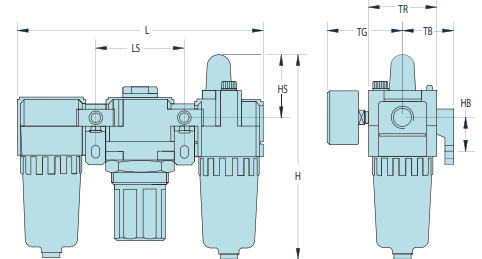

28178
HT Air Tool/AFRL
Carrying Kit



AFRL-4HTA
Standalone Unit

AFRL Stacking Filter/Regulators

Model	Port	Gauge Port	Flow Rate CFM	Flow Rate L/MIN	Bowl Shield	H IN/MM	HB IN/MM	HS IN/MM	L IN/MM	LS IN/MM	TB IN/MM	TG IN/MM	TR IN/MM
AFRL-2	1/4"	1/8"	70	2,000	yes	6.16 (156.5)	1.39 (35.3)	1.50 (38.1)	7.13 (181.1)	2.52 (64.0)	1.61 (41.0)	2.39 (60.7)	2.09 (53.1)
AFRL-2-C	1/4"	1/8"	60	1,700	yes	8.31 (211.1)	1.38 (35.1)	3.64 (92.5)	4.61 (117.1)	2.30 (58.4)	1.61 (40.9)	2.39 (60.7)	2.09 (53.1)
AFRL-3	3/8"	1/4"	140	4,000	yes	7.54 (191.5)	1.57 (40.0)	1.61 (40.9)	9.37 (238.0)	3.31 (84.1)	1.97 (50.0)	2.58 (65.5)	2.76 (70.1)
AFRL-3-C	3/8"	1/4"	105	3,000	yes	10.31 (261.9)	1.57 (39.9)	4.41 (112.0)	6.06 (153.9)	3.03 (77.0)	1.97 (50.0)	2.58 (65.5)	2.76 (70.1)
AFRL-4	1/2"	1/4"	140	4,000	yes	7.54 (191.5)	1.57 (40.0)	1.61 (40.9)	9.37 (238.0)	3.31 (84.1)	1.97 (50.0)	2.58 (65.5)	2.76 (70.1)
AFRL-8	1"	1/4"	180	5,000	yes	10.69 (271.5)	1.97 (50.0)	1.89 (48.0)	11.81 (300.0)	4.13 (104.9)	2.75 (69.9)	2.97 (75.4)	3.54 (89.9)

Air Preparation Units: Basic Functions

The supply of clean, dry air is essential to the operation of pneumatic powered tools. Use only clean filtered air for longer tool life. Provide proper airflow (CFM) and regulate air pressure (PSI) for optimum performance.

To determine unit size for application, you need to know:

- Total air flow (CFM) required for application
- Size of incoming air line and size of air line required by tool
- Air supply pressure (PSI)
- Allowable pressure drop
- Does the application require lubrication?
- Does the overall system have the required capacity?

Sockets

In addition to the models presented below, a wide variety of sockets and extensions are available. Contact an AIMCO Customer Service Associate for details, 1-503-254-6600, or toll free 1-800-852-1368.

IMPACT SOCKETS

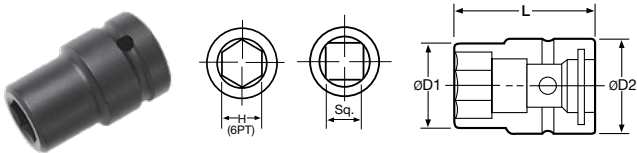

	Part No	Hex	D1 MM	D1 IN	D2 MM	D2 IN	L MM	L IN
SAE	3/4" Square Drive							
	A611/16	11/16"	30	1.18	44	1.73	50	1.97
	A63/4	3/4"	32	1.26	44	1.73	50	1.97
	A613/16	13/16"	35	1.38	44	1.73	50	1.97
	A614	14 mm	24	0.95	38	1.50	55	2.17
	A616	16 mm	27	1.06	44	1.73	50	1.97
	A617	17 mm	30	1.18	38	1.50	55	2.17
SAE	3/4" Square Drive, Deep							
	A611/16-4	11/16"	31	1.22	44	1.73	100	3.94
	A63/4-4	3/4"	33	1.30	44	1.73	100	3.94
	A613/16-4	13/16"	36	1.42	44	1.73	100	3.94
	A617-4	17 mm	31	1.22	44	1.73	100	3.94
	A618-4	18 mm	32	1.26	44	1.73	100	3.94
	A619-4	19 mm	33	1.30	38	1.50	100	3.94
SAE	1" Square Drive							
	A87/8	7/8"	37	1.46	54	2.13	59	2.32
	A815/16	15/16"	38	1.50	54	2.13	59	2.32
	A81	1"	41	1.61	54	2.13	59	2.32
	A817	17 mm	31	1.22	50	1.97	63	2.48
	A819	19 mm	33	1.30	50	1.97	63	2.48
	A821	21 mm	37	1.46	50	1.97	63	2.48
SAE	1-1/2" Square Drive							
	A142-1/8	2-1/8"	84	3.31	84	3.31	87	3.43
	A142-1/2	2-1/2"	97	3.82	86	3.39	100	3.94
	A143-1/2	3-1/2"	130	5.12	86	3.39	120	4.72
	A144-1/4	4-1/4"	155	6.10	102	4.02	140	5.51
	A1465	65 mm	99	3.90	86	3.39	100	3.94
	A1475	75 mm	112	4.41	86	3.39	110	4.33
METRIC	A1485	85 mm	125	4.92	86	3.39	120	4.72
	A14105	105 mm	151	5.95	102	4.02	130	5.12



ALLEN SOCKETS

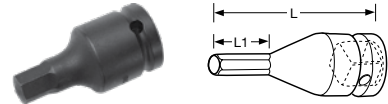

Part No	Hex	L1 MM	L1 IN	L MM	L IN
1-1/2" Allen Socket					
A1432CZ	32 mm	20.5	1.26	120	4.72

Many other allen sockets are available, including:

- 1" x 19 mm
- 1" x 22 mm
- 1" x 24 mm
- 1" x 27 mm
- 1-1/2 x 19 mm
- 1-1/2 x 22 mm
- 1-1/2 x 24 mm
- 1-1/2 x 36 mm

Contact an AIMCO Customer Service Associate for ordering options, 1-503-254-6600, or toll free 1-800-852-1368.

EXTENSIONS

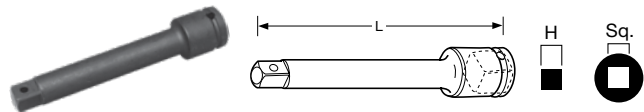

Part No	Sq Drive	Hex	L MM	L IN	D MM	D IN
A610E	3/4"	3/4"	100	3.94	44	1.73
A810E	1"	1"	102	4.02	54	2.13
A1220E	1-1/4"	1-1/4"	200	7.87	60	2.36
A1418E	1-1/2"	1-1/2"	178	7.01	84	3.31

SOCKET ADAPTERS

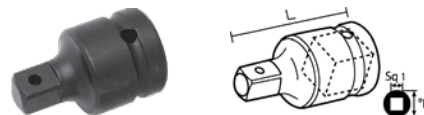

Part No	Female Sq. Drive	Male Sq. Drive	D MM	D IN	L MM	L IN
A604A	3/4"	1/2"	38	1.50	53	2.09
A806A	1"	3/4"	50	1.97	70	2.76
A128A	1-1/4"	1"	60	2.36	76	2.99
A#508A	Spline #5	1"	60	2.36	90	3.54

Sockets

ERGO-DRIVE SOCKETS

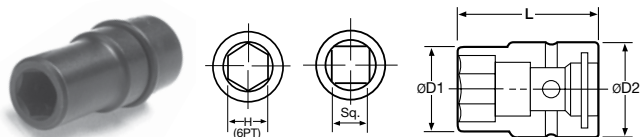

Part No	Hex	D1 MM	D1 IN	D2 MM	D2 IN	L MM	L IN
3/4" Square Drive							
A61-1/8EDS	1-1/8"	44	1.73	44	1.73	64	2.52
A61-1/4EDS	1-1/4"	49	1.91	44	1.73	66	2.60
A61-1/2EDS	1-1/2"	57	2.24	44	1.73	68	2.68
A618EDS	18 mm	31	1.22	44	1.73	60	2.36
A624EDS	24 mm	40	1.52	40	1.73	65	2.36
1" Square Drive							
A815/16EDS	15/16"	38	1.50	54	2.13	69	2.72
A8100EDS	100 mm	136	5.35	76	2.99	120	4.72

ERGO-DRIVE EXTENSIONS

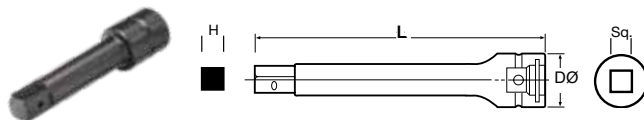

Part No	Sq Drive	H	L MM	L IN	D MM	D IN
3/4" Square Drive						
A676EDE	3/4"	3/4"	76	2.99	40	1.58
A6100EDE	3/4"	3/4"	100	3.94	40	1.58
A6150EDE	3/4"	3/4"	150	5.91	40	1.58
A6200EDE	3/4"	3/4"	200	7.87	40	1.58
1" Square Drive						
A8150EDE	1"	1"	150	5.91	54	2.13
A8200EDE	1"	1"	200	7.87	54	2.13

CUSTOM BITS, SOCKETS, AND EXTENSIONS FOR THE POWER TOOL USER

AIMCO can provide specials for virtually any application. From design to delivery, AIMCO's quick response ensures high quality, tight tolerance specials.

Specials are available in every style including:

- Deep Socket
- Extended Socket
- Universal
- Allen Head
- Torx Head
- Socket Adapter
- Nut Runner Socket
- Nut Runner Joint
- Nutsetter
- Magnetic Nutsetter
- Universal Nutsetter
- Screwdriver Bits



Contact an AIMCO Customer Service Associate at 1-503-254-6600, or toll free 1-800-852-1368.

Applications

AcraDyne's High Torque Pneumatic Bolting Tools offer a reliable and dependable solution for the installation and removal of heavy-duty fasteners. Appropriate for use in industries requiring high torque capability, accuracy, power, and safety.



PETROCHEM

- Reactor
- Cracker
- Heat-Exchanger
- Valves, Pumps
- Compressors
- Heaters



COMPRESSOR STATION

- Tie Rod
- Engines
- Compressors
- Turbines
- Pipe-Line
- Well Heads



STEEL MILL

- Sintering
- Blast Furnace
- Hot Strip
- Cold Roll
- Central Machine
- Pipe Shop



WIND TURBINE

- Tower Bolts
- Foundation Bolts
- Bearing Housing
- Shrink Disc
- Gear Mount
- Hub Bearing



OFFSHORE

- Diesel Engine
- Mud Pump
- Crane
- Vessel Thruster
- Stacks



POWER

- Steam Turbine
- Gas Turbine
- Hydro Turbine
- Comb. Cycle
- Valves, Pumps, Reactors, Pipes



MINING

- Shovel & Drill
- Ball Mill
- Long-Wall
- Hoist
- Car Carrier



CORPORATE HEADQUARTERS
10000 SE Pine Street
Portland, Oregon 97216
Phone: (503) 254-6600
Toll Free: 1-800-852-1368

AIMCO CORPORATION DE MEXICO SA DE CV
Ave. Cristobal Colon 14529
Chihuahua, Chihuahua. 31125
Mexico
Phone: (01-614) 380-1010
Fax: (01-614) 380-1019