

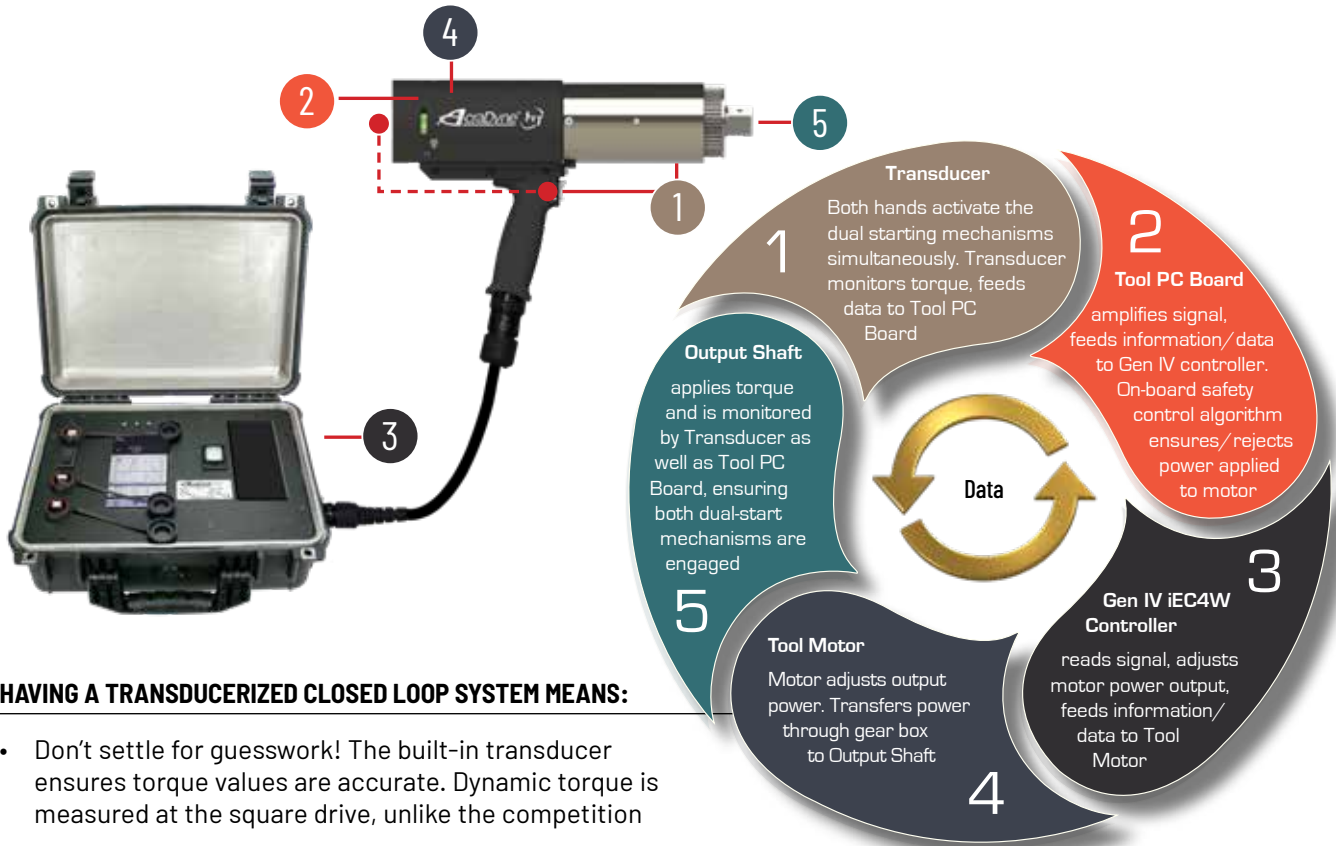

HIGH CAPABILITY BOLTING TOOLS



THE DRIVING FORCE IN CRITICAL BOLTING



HAVING A TRANSDUCERIZED CLOSED LOOP SYSTEM MEANS:

- Don't settle for guesswork! The built-in transducer ensures torque values are accurate. Dynamic torque is measured at the square drive, unlike the competition
- Torque measurement is unaffected by changes in gear efficiency, normal tool wear between calibrations, temperature, voltage, or motor performance
- On-tool LEDs for Accept/Reject signals
- The system can easily be verified and calibrated anywhere
- Interchangeable tools, cables, and controllers – calibrations are specific to the tool not the system as a whole

CHOOSE YOUR HANDLE



PERQ Advantages

- PRODUCTIVITY**
 - High tool speeds
 - Able to work with a single operator
 - Automatic evaluation and data collection
- ERGONOMICS**
 - Multiple handle configuration options for optimal tool handling
 - Programmable acceleration to manage reaction bar behavior against reactive surface
- RELIABILITY**
 - Production duty cycle durability – gearing tested to 100,000 cycles before maintenance
- QUALITY**
 - Torque measurement at the output – torque delivered is the torque reported
 - Broad range of programmable tightening strategies to handle joint characteristics
 - On-board torque calibration against known standards to ensure accurate results



HIGH TORQUE DC BOLTING TOOLS

Critical bolting demands tools that deliver high torque with superior performance. Couple with AcraDyne's Controller, the HT Series tools combine these features in an electric, high-torque bolting system that beats the competition in accuracy, speed, and safety.

FEATURES AND BENEFITS

- Built-in integral transducer for optimal monitoring and control
- One of the most accurate high-torque tools in the world
- 250 Nm - 17,000 Nm torque range
- Ergonomic, robust design with five handle configurations that are also available in dual-lever models
- The world's most advanced traceable system at the output
- Three tightening strategies:
 - *Torque Control*: Drive the tool to a pre-set Target Torque
 - *Angle Control*: Drive the tool to or measure a pre-set Degree of Angle
 - *Yield Control*: Drive the tool to the Fastener Yield Point to achieve maximum clamp load
- Data retrieval
- Optional rugged carrying/storage case available



Pistol Type (AEP)



Axial Type (AEJ)



Rear Mounted Pistol (AED)



Straight Lever Type (AES)



Fixtured Type (AEF)

HT Fixed Gearcase Tools

Model	Approx. Torque		Approx. Speed	Weight		Total Length (incl sq. dr)		Dia.		Drive	Sound Level
	NM	FT-LB	RPM	KG	LB	MM	IN	MM	IN	IN	dB(A)
HT Series Fixed Gearcase Models (R) = Pistol Tool with Rear Exit Cable (B) = Fixtured Model with Bottom Exit Cable											
6000 Series											
AE(P)4A66250B(R)	250	185	315	4.6	10.5	P = 289	11.4	66	2.6	0.75	66
AE(D)(S)(J)(F)4A66250B											
AE(P)4A66425B(R)	425	315	165	4.6	10.5	P(R) = 331	13	66	2.6	0.75	66
AE(D)(S)(J)4A66425B											
AE(F)4A66425B(B)						D = 388	15.3				
AE(P)A66625B(R)	625	460	106	4.8	10.5	J = 331	13	66	2.6	0.75	66
AE(D)(S)(J)4A66625B											
AE(F)4A66625B(B)						F = 331	13				
AE(P)4A66925B(R)	925	682	72	4.8	10.5	F(B) = 353	13.9	66	2.6	0.75	66
AE(D)(S)(J)(F)4A66925B											
7000 Series											
AE(P)(D)(S)(J)4A771200B	1,200	885	65	6.6	14.5	P = 302	11.9	77.5	3.1	1	66
AE(F)4A771200B(B)											
						D = 301	11.9				
						S = 302	11.9				
						J = 343	13.5				
						F = 343	13.5				
AE(P)(D)(S)(J)4A773000B	3,000	2,213	25	7.5	16.5	P = 337	13.3	77.5	3.1	1	66
AE(F)4A773000B(B)											
						D = 337	13.3				
						S = 337	13.3				
						J = 379	14.9				
						F = 379	14.9				
8000 Series											
AE(P)(D)(J)(F)4A884200B1	4,200	3,100	12	11.1	24.5	P = 384	15.1	91.2	3.6	B1 = 1	66
AE(P)(D)(S)(J)(F)4A884200B											
						D = 480	18.9			B = 1.5	
						S = 546	21.5				
AE(P)(D)(J)(F)4A885000B	5,000	3,700	9.3	11.1	24.5	J = 410	16.1			1.5	66
						F = 410	16.1				
AE(P)(D)(J)(F)4A896500B	6,500	4,800	7	15.7	34.5	P = 438	17.2	103.8	4.1	1.5	66
AE(F)4A896500B(B)											
						D = 533	21				
						S = 599	23.6				
AE(P)(D)(S)(J)(F)4A898100B	8,100	6,000	5	15.7	34.5	J = 463	18.2				
						F = 462	18.2				

* 8,100 Nm - 17,000 Nm models are not supported by the Gen III controller platform. The Gen IV controller platform is required.



360° Swivel Gearcase Nutrunners

FEATURES AND BENEFITS

- Same features and benefits of fixed gearcase models
- Ergonomic, robust design with two handle configurations



2,800 Nm Torque
AEP4W872800B



8,100 Nm Torque
AEP4B898100B



8,100 Nm Torque
AEJ4B898100B

HT 360° Swivel Gearcase Tools

Model	Approx. Torque NM	Approx. Torque FT-LB	Approx. Speed RPM	Weight KG	Weight LB	Length (incl sq. dr) MM	Length (incl sq. dr) IN	Dia. MM	Dia. IN	Drive IN	Sound Level dB(A)
HT Series 360° Swivel Gearcase Models (R) = Pistol Tool with Rear Exit Cable											
6000 Series											
AE(P)4B66250B(R) AE(D)(J)4B66250B	250	185	315	5.3	12					0.75	66
AE(P)4B66425B(R) AE(D)(J)4B66425B	425	315	165	5.3	12	P = 327 P(R) = 368 D = 429 J = 369	12.9 14.5 16.9 14.5	67.3	2.7	0.75	66
AE(P)4B66625B(R) AE(D)(J)4B66625B	625	460	106	5.5	12					0.75	66
AE(P)4B66925B(R) AE(D)(J)4B66925B	925	682	72	5.5	12					0.75	66
7000 Series											
AE(P)(J)4B771200B	1,200	885	65	7.3	16	P = 339 J = 381	13.4 15	77.5	3.1	1	66
AE(P)(J)4B773000B	3,000	2,213	25	8.2	18						
8000 Series											
AE(P)(D)(J)4B884200B1 AE(P)(D)(J)4B884200B	4,200	3,100	12	11.8	26	P = 422 D = 518 J = 446	16.6 20.4 17.6	91.2	3.6	B1 = 1 B = 1.5	66
AE(P)(J)4B896500B	6,500	4,800	7	16.4	36	P = 475 J = 499	18.7 19.7	103.8	4.1	1.5	66
AE(P)(D)(J)4B898100B*	8,100	6,000	5	16.4	36	P = 475 D = 571 J = 499	18.7 22.5 19.7	103.8	4.1	1.5	66
AE(P)4B998100B*	8,100	6,000	5	21.8	48	532	20.9	112	4.4	1.5	66
Models for Extreme Duty / Low Power Environments											
Wind Series											
AE(P)(J)4W872800B	2,800	2,065	9	10.0	22	P = 406 J = 430	16 17	76	3.0	1	66
AE(P)(D)(J)4W885000B1* AE(P)(D)(J)4W885000B*	5,000	3,700	4.5	11.8	26	P = 422 D = 518 J = 446	16.6 20.4 17.6	91.2	3.6	B1 = 1 B = 1.5	66

* 8,100 Nm - 17,000 Nm models are not supported by the Gen III controller platform. The Gen IV controller platform is required.

AIMCO can provide customized tooling solutions for even the most unique applications. Let us propose a solution tailored to your needs. Contact an AIMCO Customer Service Associate for more details, 1-503-254-6600, or toll free 1-800-852-1368.



HIGH TORQUE DC BOLTING TOOLS

AcraDyne HT DC Angle Tools provide the perfect solution for space-limited applications. Compact, durable head houses a precision right-angle gearset that fits into the tightest spaces

FEATURES AND BENEFITS

- Transducerized closed loop control at the output like all AcraDyne HT-Series tools
- These low-profile head, small-diameter, lever-operated tools, with the torque measured at the output, offer a unique solution
- The torque reported is the torque delivered
- One of the most accurate high-torque right-angle tools in the world
- Smallest tools of their kind on the market
- Same durable, high-cycle gearing as our other HT-series tools
- Models up to 17,000 Nm available upon request
- These models are fixtured tools



5000 Series HT Angle Tools

MODEL	Max. Torque*		Torque Range		Free Speed RPM	Weight		Output SO Drive	Dimensions									
	NM	FT-LB	NM	FT-LB		LB	KG		A		B		C		D		E	
									IN	MM	IN	MM	IN	MM	IN	MM	IN	MM
AEN356540A	540	398	135 - 540	100 - 398	109	13.1	5.95	3/4"	22.58	573.6	2.31	58.7	4.75	120.6	4.05	102.8	1.33	33.7
AEN3571000A	1,000	737	250 - 1,000	184 - 737	61	16.3	7.39	1"	22.92	582.2	2.31	58.7	5.36	136.1	4.44	112.7	1.53	38.7
AEN3571600A	1,600	1,180	400 - 1,600	295 - 1,180	33	16.7	7.57	1"	22.92	582.2	2.31	58.7	5.36	136.1	4.44	112.7	1.53	38.7
AEN3572600A	2,600	1,917	650 - 2,600	479 - 1,917	21	18.5	8.40	1"	22.92	582.2	2.31	58.7	6.77	171.9	5.86	148.8	1.53	38.7

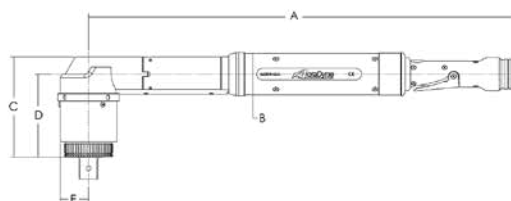



HIGH TORQUE DC BOLTING TOOLS

A BETTER ANGLE ON BIG JOBS



AcraDyne HT DC Angle Nutrunner is THE Tool for Servicing Blades on Wind Turbines



This **unique tool configuration**, built with all of the AcraDyne HT advantages, is made in a size that allows access to blade bolts that cannot be easily accessed by other continuous drive tools. The 360° swivel gearcase allows for precise placement of the tool reaction bar against reactive surfaces for ease of use.



AcraDyne's HT DC angle nutrunner is one of the smallest tools of its kind on the market. A powerful motor combined with a short-length handle and a 360° swivel gearcase gives you ultimate flexibility in limited-space applications.

FEATURES AND BENEFITS

- Easy access to previously hard-to-reach blade bolts
- Faster speed than hydraulic tools
- Acquires data in both loosening and retightening directions
- Preset strategies and sequencing for ease of use
- Most intuitive user interface in the industry for setup and data transfer
- Slip ring gearbox for 360° reaction bar movement
- Dual-lever option available
- Measures traceable, dynamic torque directly at the square drive, and the built-in transducer ensures accurate torque values. The torque reported is the torque delivered
- One of the most accurate high-torque right-angle tools in the world
- Same durable, high-cycle gearing as AcraDyne's industry-leading HT series tools
- Available with an optional rugged, weather-resistant carrying case



Custom reaction bars available

7000 Series HT DC Angle Tools

Model*	Max. Torque		Torque Range		Free Speed RPM	Length (Minus Reaction Bar)		Weight		Output SQ DRIVE
	NM	FT-LB	NM	FT-LB		IN	MM	LB	KG	
AEN4B771200B(DL)	1,200	885	240 - 1,200	177 - 885	38	16.6	422	17.9	8.1	1"
AEN4B773000B(DL)	3,000	2,200	600 - 3,000	443 - 2,200	15	16.6	422	20.4	9.3	1"

* Add "DL" to Part Numbers for Dual Lever

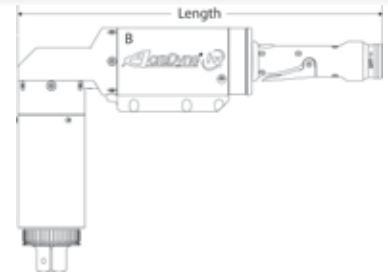

Gen IV iEC4W Field Controller: High Torque with High Tech

The Gen IV Field Controller (see page 14) is the core of the modular AcraDyne DC system. One controller will command any tool in the AcraDyne line – including the HT DC Angle Tool – from 1 Nm to 17,000 Nm, all with the same modular standard cable design.



HIGH TORQUE DC DUAL-LEVER BOLTING TOOLS

Provide Additional Safety by Avoiding Accidental Tool Start

FEATURES AND BENEFITS

- Built-in integral transducer for optimal monitoring and control
- One of the most accurate high-torque tools in the world
- 250 Nm - 17,000 Nm
- Two-Hand No Tie Down Operation
 - No Tie Down Control: Operator must have both hands on and activating the dual-starting mechanisms simultaneously. Both hands must remain in position, activating the dual controls, at all times in order for the tool to operate.
- Additional safety when using a tool with a reaction bar or nose extension. Operator's hands remain on the controls and not in a position where they could be impacted by reaction devices
- Hands stay clear of application
- Helps avoid accidental starting of the tool
- Available in Fixtured (F), J-Handle (J), Straight (S), as well as dual-handle configurations
- Designed and **MADE IN THE USA**



AEJ Type



AEF Type



AES Type

HT Dual-Lever Nutrunners: **SAFETY** is **VITAL** in Critical Bolting

AcraDyne's Nutrunners are designed with ultimate operator safety in mind. The optional dual-lever design helps prevent:



⚠ Injuries from Accidental Tool Start

Two-hand operation with no tie-down feature requires the operator to use both hands on the trigger simultaneously. This eliminates the possibility of accidental tool start and keeps both of the operator's hands out of harm's way.

⚠ Strain Caused by Awkward Tool Operation

Multiple handle styles ensure the safest, most ergonomic tool for your specific application.

⚠ Hand and Finger Trauma

Significantly reduce the risk of crushed or mutilated fingers from unintended tool start.

Protect your most valuable asset – your tool operator.



HIGH TORQUE DC DUAL-LEVER BOLTING TOOLS



HT Fixed Gearcase Dual-Lever Tools

Dual Lever Model	Approx. Torque		Approx. Speed RPM	Weight		Length (incl sq. dr)		Dia.		Drive IN	Sound Level dB(A)
	NM	FT-LB		KG	LB	MM	IN	MM	IN		
HT Series Fixed Gearcase: Dual-Lever Models For Straight Type Tools Only: (L) = Left-Side Handle (R) = Right-Side Handle											
6000 Series											
AE(P)(F)4A66250BDL AE(S)4A66250BDL(L)(R)	250	185	315	3.9	9	P = 314 F = 331 S = 440	12.4 13 17.3	67.3	2.7	0.75	66
AE(P)(F)4A66425BDL AE(S)4A66425BDL(L)(R)	425	315	165	3.9	9					0.75	66
AE(P)(F)4A66625BDL AE(S)4A66625BDL(L)(R)	625	460	106	4.1	9					0.75	66
AE(P)(F)4A66925BDL AE(S)4A66925BDL(L)(R)	925	682	72	4.1	9					0.75	66
7000 Series											
AE(P)(F)4A771200BDL AE(S)4A771200BDL(L)(R)	1,200	885	65	5.9	13	P = 324 F = 343 S = 453	12.7 13.5 17.8	77.5	3.1	1	66
AE(P)(F)4A773000BDL AE(S)4A773000BDL(L)(R)	3,000	2,213	25	6.8	15	P = 359 F = 379 S = 488	14.1 14.9 19.2	77.5	3.1	1	66
8000 Series											
AE(F)4A884200BDL AE(F)4A884200BDL	4,200	3,100	12	10.4	23	410	16.1	91.2	3.6	B1 = 1 B = 1.5	66
AE(F)4A885000BDL	5,000	3,700	9.3	10.4	23	410	16.1	91.2	3.6	1	66
AE(P)(F)4A896500BDL	6,500	4,800	7	15.0	33	P = 438 F = 462	17.2 18.2	102.4	4	1.5	66
AE(F)(J)4A898100BDL*	8,100	6,000	5	15.0	33	F = 462 J = 462	18.2 18.2	102.4	4	1.5	66

* 8,100 Nm - 17,000 Nm models are not supported by the Gen III controller platform. The Gen IV controller platform is required.

HT 360° Swivel Gearcase Dual-Lever Tools

Dual Lever Model	Approx. Torque		Approx. Speed RPM	Weight		Length (incl sq. dr)		Dia.		Drive IN	Sound Level dB(A)
	NM	FT-LB		KG	LB	MM	IN	MM	IN		
HT Series 360° Swivel Gearcase: Dual-Lever Models For Straight Type Tools Only: (L) = Left-Side Handle (R) = Right-Side Handle											
6000 Series											
AE(P)(F)4B66250BDL AE(S)4B66250BDL(L)(R)	250	185	315	4.6	10.5	P = 353 F = 369 S = 630	13.9 14.5 24.8	67.3	2.7	0.75	66
AE(F)4B66425BDL AE(S)4B66425BDL(L)(R)	425	315	165	4.6	10.5						66
AE(F)4B66625BDL AE(S)4B66625BDL(L)(R)	625	460	106	4.8	10.5						66
AE(F)4B66925BDL AE(S)4B66925BDL(L)(R)	925	682	72	4.8	10.5						66
7000 Series											
AE(P)(F)4B771200BDL AE(S)4B771200BDL(L)(R)	1,200	885	65	6.6	14.5	P = 361 F = 382 S = 492	14.2 15 19.4	77.5	3.1	1	66
AE(P)(F)4B773000BDL AE(S)4B773000BDL(L)(R)	3,000	2,213	25	7.5	16.5	P = 398 F = 418 S = 528	15.7 16.5 20.8	77.5	3.1	1	66
8000 Series											
AE(P)(F)4B896500BDL	6,500	4,800	5	16.4	36	P = 475 F = 499	18.7 19.7	104	4.1	1.5	66
AE(J)4B898100BDL*	8,100	6,000	5	16.4	36	499	19.7	104	4.1	1.5	66

* 8,100 Nm - 17,000 Nm models are not supported by the Gen III controller platform. The Gen IV controller platform is required.

AIMCO can provide customized tooling solutions for even the most unique applications. Let us propose a solution tailored to your needs. Contact an AIMCO Customer Service Associate for more details, 1-503-254-6600, or toll free 1-800-852-1368.



Full-Strength Tools for Big Jobs

AcraDyne's HTXD Nutrunner/Gen IV Controller System is one of the Most Accurate High-Torque Bolting Systems in the World



- Measures traceable, dynamic torque directly at the square drive, and the built-in transducer ensures accurate torque values. The torque reported is the torque delivered
- Available in J handle and Pistol handle configurations
- Extreme Duty engineering with motors rated for bolting applications near continuous duty
- Dual J-Handle models have additional safety features: Operators must use both hands on the trigger simultaneously, eliminating the possibility of accidental tool start and keeping both of the operator's hands out of harm's way
- Wide range of tightening strategies available including Torque Control, Torque plus Angle, Angle Control, and Yield Control

AcraDyne's HTXD Systems measure traceable, dynamic torque directly at the square drive and the built-in transducer ensures accurate torque values.

- Accuracy and traceability are assured from the first fastening to the last
- Torque reported is the torque delivered
- Accuracy not affected by gearing efficiency

Tools with the gearing after the transducer cannot claim this!



J-Handle Model
12,000 Nm



Pistol Model
12,000 Nm



12,000 Nm

Dual J-Handle Models



17,000 Nm

HT 360° Swivel Gearcase Bolting Tools for Extreme Duty

Model	Series	Approx. Torque		Approx. Speed RPM	Weight *		Length (incl sq. dr)		Dia.		Drive IN	Sound Level dB(A)
		NM	FT-LB		KG	LB	MM	IN	MM	IN		
360° Swivel Gearcase Models												
AEJ = J Handle/Axial Type		AEP = Pistol Type			Single-Handle Models Standard. Add "DL" to Model Numbers for Dual Handles (AEJ models only)							
AEP4W998100B	9000	8,100	6,000	2.3	21.8	48	544	21.4	104	4.1	1.5	66
AEJ4W998100B	9000	8,100	6,000	2.3	21.8	48	544	21.4	104	4.1	1.5	66
AEJ4U998100BDL	9000	8,100	6,000	2.3	21.8	48	427	16.8	104	4.1	1.5	66
AEP4W9X12000B	9X	12,000	8,850	2	31.8	70	572	22.5	131	5.2	1.5	66
AEJ4W9X12000B	9X	12,000	8,850	2	31.8	70	572	22.5	131	5.2	1.5	66
AEJ4U9X12000BDL	9X	12,000	8,850	2	31.8	70	441	17.4	131	5.2	1.5	66
AEP4W9Y17000B	9Y	17,000	12,500	1	42.6	94	381	15	153	6.0	2.5	66
AEJ4W9Y17000B	9Y	17,000	12,500	1	42.6	94	381	15	153	6.0	2.5	66
AEJ4U9Y17000BDL	9Y	17,000	12,500	1	42.6	94	458	18	153	6.0	2.5	66

* Weight is tool only w/o Socket and Reaction Bar

Ultimate Operator Safety for Lifting Larger Bolting Tools

AcraDyne's XD Lift Assist device for tool suspension and use allows for easy handling of equipment that otherwise would need two operators to position.

FEATURES AND BENEFITS

- Lift can be assembled/disassembled in less than 15 minutes
- Can be used inside wind turbines at deck platforms
- Designed for a wide variety of applications including narrow tower platforms and ladder spaces
- Lift Assist weighs 30 kg / 67 lbs
- Weight of unit is below the weight allowed to be lifted by personnel inside or outside the tower
- Disassembled Lift Assist is transported in a load-rated bag that can be lifted manually or by hoist within the tower
- Device is rated for loads up to 200 kg / 440 lbs
- Full-swivel wheels with locking brakes make movement and repositioning easy

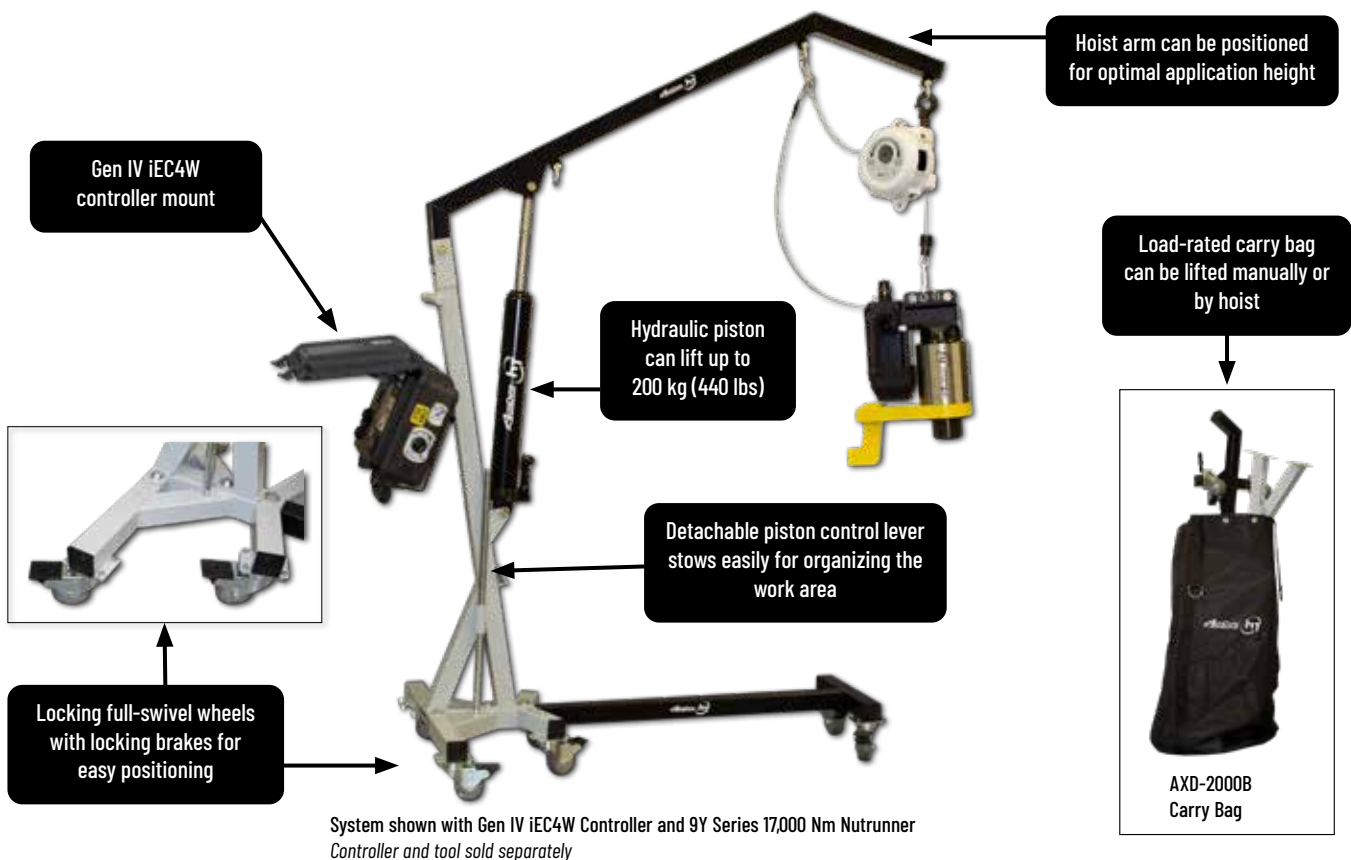

Ultra Torque ABP-CTA Series

Unmatched Accuracy for Higher-Torque Applications

FEATURES AND BENEFITS

- Transducerized for precise delivery of torque and angle to the fastener
- Usable stand-alone or with AcraDyne iBC series Controller for line controls and/or data integration with QMS systems
- Sophisticated control set with AcraDyne Tool Manager program with 99 PSETS available
- Operator feedback with OLED screen, audible and tactile feedback
- Wide variety of strategies
 - Torque
 - Angle
 - Torque Plus Turn
 - Torque Minus Turn
 - And more...
- Available with Two-Hand, No Tie Down Button to ensure operator safety from accidental contact with reaction bar
- Standard Offset, Deep Offset, and Flat Reaction Bars available. Custom reaction bars available by request
- Tool supplied with one battery (P/N AB-B1850LI), see page and standard reaction bar. Charger is purchased separately:
 - AB-C18110 (120VAC) Charger or
 - AB-C18220 (220VAC) Charger



AcraDyne Cordless ABP-CTA Ultra Torque Series Tools

Model	Max Torque		Max Speed RPM	Length		Weight	Gearbox Diameter	
	NM	FT-LB		MM	IN		MM	IN
ABP-CTA250(W)	250	185	27	335	13.2	w/out battery: 3.7 kg / 8.04 lb w/battery: 4.3 kg / 9.44 lb	67	2.6
ABP-CTA450(W)	450	332	14	335	13.2	w/out battery: 3.7 kg / 8.04 lb w/battery: 4.3 kg / 9.44 lb	67	2.6
ABP-CTA650(W)	650	480	9.4	335	13.2	w/out battery: 3.7 kg / 8.04 lb w/battery: 4.3 kg / 9.44 lb	67	2.6
ABP-CTA950(W)(DL)	950	700	6.4	335	13.2	w/out battery: 3.7 kg / 8.04 lb w/battery: 4.3 kg / 9.44 lb	67	2.6
ABP-CTA1400(W)(DL)	1400	1000	4	338	13.3	w/out battery: 4.0 kg / 8.85 lb w/battery: 5.1 kg / 11.25 lb	77.5	3.1
ABP-CTA3000(W)(DL)	3000	2200	2.1	374	14.7	w/out battery: 5.6 kg / 12.31 lb w/battery: 6.2 kg / 13.71 lb	77.5	3.1

W = WiFi option DL = Dual Trigger



ACRADYNE® HT SERIES FIELD CONTROLLER

Improved design of AcraDyne's powerful Gen IV Field Controller means increased durability, lighter weight, and quick and easy setup



iEC4WF Field Controller



Rugged, Lightweight Case

FEATURES AND BENEFITS

- Optimized for extreme duty applications >5,000 Nm
- The Gen IV Controller utilizes three tightening strategies:
 - Torque Control: Drive the tool to a pre-set Target Torque
 - Angle Control: Drive the tool to or measure a pre-set Degree of Angle
 - Yield Control: Drive the tool to the Fastener Yield Point to achieve maximum clamp load
- Multiple fastening strategies – Program up to 256 parameters with as many as 20 steps
- Jobs capability – 99
- Real-time curve viewing. Curve storage – 20,000
- Rundown storage – 1,000,000
- Event log – 5,000
- Backup & restore through USB
- Weatherproof, rugged case protects from the toughest environments
- Compact design weighs less than 20 lbs
- Ground clamp is quick and easy to set up and eliminates additional parts that are substantially heavy
- Optional tool fan kit helps prevents tool overheating
- Capable of interface with the AcraDyne series Dual-Lever tools that offer two-hand, no tie down functionality
- 110V – 220V compatible
- Single Ethernet port increases speed of connectivity, signal stability, and signal consistency
- Commands any tool in the AcraDyne line from 1 Nm to 17,000 Nm, all with one cable

PERQ Advantages

<p>PRODUCTIVITY</p>	<ul style="list-style-type: none"> • Replace multiple conventional tools with one flexible controlled system • Quick and easy setup • Fan kit reduces downtime due to tool overheating
<p>ERGONOMICS</p>	<ul style="list-style-type: none"> • Compact, rugged case with easy carry handle makes field use easy and convenient • Lightweight for operator comfort
<p>RELIABILITY</p>	<ul style="list-style-type: none"> • Weatherproof rugged case • Industrial touch screen
<p>QUALITY</p>	<ul style="list-style-type: none"> • Controlled tightening and consistent torque control improves quality • Process controls reduce human error, and ensure no missed fasteners, stripped threads, rehits, or damaged threads • No premature shut-off

Model	Description	Dimensions W x D x H	Weight LB KG	
iEC4WF	Field use controller for use with 110V or 220V service	16.1" x 12.8" x 6.9" 408 mm x 326 mm x 175 mm	18.5	8.4
Additional Field Controllers				
iEC4W1	Field use controller with isolation transformer for use with 110V service	16.1" x 12.8" x 6.9" 408 mm x 326 mm x 175 mm		
iEC4W2	Field use controller with isolation transformer for use with 220 V service	16.1" x 12.8" x 6.9" 408 mm x 326 mm x 175 mm		

ACRADYNE® HT SERIES FIELD CONTROLLER SOFTWARE

AcraDyne's software package is on-board every AcraDyne controller and is provided FREE of charge. This comprehensive, user-friendly program allows programming, analysis, and diagnostics.

The software is based on a standard web browser, allowing you to connect the AcraDyne controller with any computer, tablet, or smart device. Connect through Ethernet, USB, or wirelessly via a network connected to both devices.

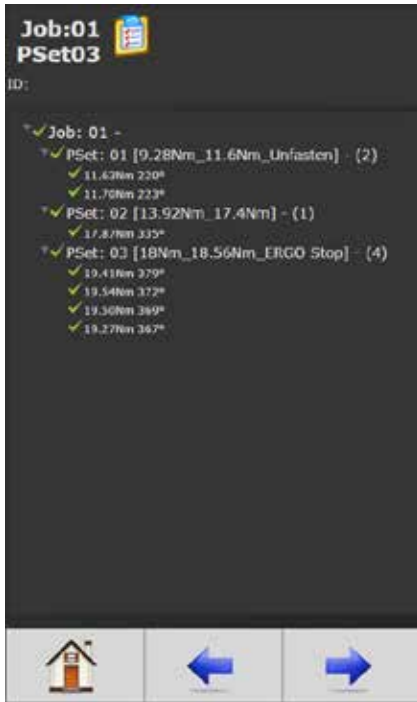

Adding and editing Parameter Sets (256) and Jobs (99) is easy and intuitive in the parameter set up function.



View curve results in real time or view stored results. As many as 20,000 curve results can be stored in memory.

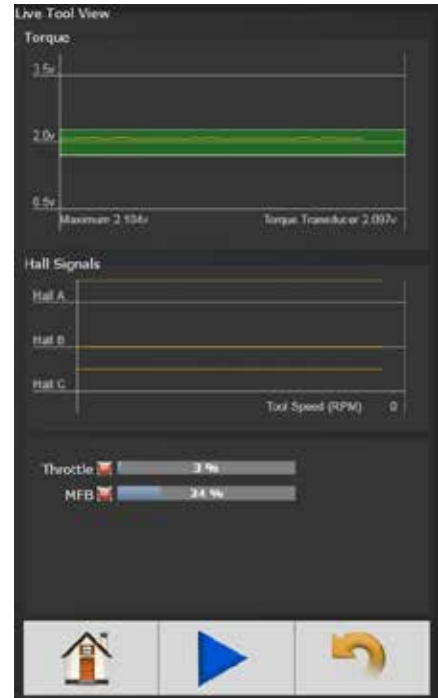

Tool programming and diagnostics for repair, calibration and advanced troubleshooting.



Choose from several run screens that display easy to view, large screen indicators.



NOSE EXTENSIONS

FEATURES AND BENEFITS

- Ideal for hard-to-reach applications when a torque tube, or arm, is not desirable
- A cost-effective, more flexible option compared to a multiple spindle system
- Common applications:
 - Wheel install and repair stations
 - Large flange assembly
 - Mining vehicle shovel bolts
 - Railway equipment maintenance
 - Oil and gas industry well fixtures



28050



28480

HT GEARHEAD TOOLS

FEATURES AND BENEFITS

- Application-specific, custom made tools fit virtually any application
- Same durable gearing as found on AcraDyne's standard HT series tools
- Model types available:
 - HT Offset Gearhead tools
 - HT Right Angle with Offset Gearhead tools
 - HT Right Angle Air tools with Offset Gearhead

Custom accessories are available for your application. Contact an AIMCO Customer Service Associate for more details, 1-503-254-6600, or toll free 1-800-852-1368.





HIGH TORQUE PNEUMATIC BOLTING TOOLS

FEATURES AND BENEFITS

AcraDyne's High Torque Pneumatic Bolting Tools offer a reliable and dependable solution for the installation and removal of heavy-duty fasteners. Appropriate for use in industries requiring high torque capability, accuracy, power, and safety.



AAP1B66600A



AAP1B76950A



AAP1B772000A



AAP1B885100A

- Modular design allows for ease of maintenance
- Interchangeable motors and gearing
- Same proven and reliable gearbox as the AcraDyne DC line
- One-hand reverse



AAP1B Series Tools

Model	Torque (NM)	Torque (FT-LB)	Speed (RPM)	Weight (LB)	Square Dr. (IN)	Air Consumption (CFM)
AAP1B66400A	400	300	57	9.75	3/4	22.9
AAP1B66600A	600	450	39	9.75	3/4	22.9
AAP1B66850A	850	625	27	9.75	3/4	22.9
AAP1B76950A	950	700	31	10.4	3/4	26.3
AAP1B771350A	1,350	1,000	22	10.4	1	26.3
AAP1B772000A	2,000	1,475	14	12.7	1	26.3
AAP1B772950A	2,950	2,175	9	14.9	1	26.3
AAP1B885100A	5,100	3,775	8	23	1-1/2	31.5

AIR PREPARATION UNITS

Many stacking filter/regulator combinations are available. See page 28 for options.



AFRL-4



AFRL-4HTA Standalone Unit

28178 HT Air Tool/AFRL Carrying Kit





HIGH TORQUE HIGH-SPEED PNEUMATIC TOOLS

Our High-Torque, High-Speed Pneumatic Bolting Tools offer a reliable and dependable solution for the installation and removal of heavy-duty fasteners with high torque capability, accuracy, power, and safety.

FEATURES AND BENEFITS

- Dual motor design provides extremely fast rundown speed
- Improved torque to weight ratio
- Full swivel gearcase facilitates reaction bar positioning for ease of use and operator comfort
- Handle exhaust with low sound level
- Uses the same durable and reliable gearbox from our DC line of high torque tools
- Modular design allows for easy maintenance
- Two-piece handle construction enables flexible handle design
- Available in reversible and non-reversible models



AAP2B Series Tools

Model	Torque		Speed (RPM)	Weight		Length		Square Dr. (IN)
	(NM)	(FT-LB)		(LB)	(KG)	(IN)	(MM)	
AAP2B76250A	250	185	660	10.5	4.8	10	255	3/4
AAP2B76450A	450	330	335	10.5	4.8	10	255	3/4
AAP2B76650A	650	480	223	10.5	4.8	10	255	3/4
AAP2B76950A	950	700	153	10.5	4.8	10	255	3/4
AAP2B771400A	1,400	1,000	110	14.6	6.6	10	255	1
AAP2B772000A	2,000	1,475	63	14.8	6.7	11.2	284	1
AAP2B773000A	3,000	2,210	52	15.0	6.8	11.6	293	1
AAP2B785100A	4,800	3,540	26.5	19.7	8.9	13.3	338	1.5

AAP2B Series Reversible Tools

Reversible Model	Torque		Speed (RPM)	Weight		Length		Square Dr. (IN)
	(NM)	(FT-LB)		(LB)	(KG)	(IN)	(MM)	
AAP2B76250AR	250	185	660	12.3	5.6	12.5	317	3/4
AAP2B76450AR	450	330	335	12.3	5.6	12.5	317	3/4
AAP2B76650AR	650	480	223	12.3	5.6	12.5	317	3/4
AAP2B76950AR	950	700	153	12.3	5.6	12.5	317	3/4
AAP2B771400AR	1,400	1,000	110	16.4	7.4	12.6	319	1
AAP2B772000AR	2,000	1,475	63	16.6	7.5	13.6	346	1
AAP2B773000AR	3,000	2,210	52	16.8	7.6	14.0	356	1
AAP2B785100AR	4,800	3,540	26.5	21.5	9.7	15.8	400	1.5



HIGH TORQUE CORDLESS XT SERIES TOOLS

Transducerized Cordless Freedom for Your Bolting Applications



AcraDyne's XT Series Cordless Tool is an excellent choice for any application that requires flexibility and uninterrupted operation. These high-efficiency tools feature a brushless motor and provide three selectable tightening strategies: Torque Control, Torque Control with Angle Reporting, and Angle Control with Torque Reporting.

The built-in transducer means precise measurement and traceability. The digital display panel facilitates programming, allows changes in preset values and strategies, and accesses stored information. User interface software, like all AcraDyne products, is available at no cost to the user and has no licensing requirements.



FEATURES AND BENEFITS

- Built-in transducer for measurement and traceability
- Torque overload limit function removes responsibility from the operator
- Ultimate flexibility with three selectable tightening strategies:
 - Torque Control
 - Torque Control with Angle Monitor
 - Torque Control plus Angle
- Temperature-monitoring sensor helps prevent overheating
- High-efficiency brushless motor provides longer motor life and increased efficiency
- Monitor and review reliable data with results stored on tool log and easily extractable through USB
- User-friendly digital adjustment and display of wrench status provides quick operator feedback
- Anti-Windup feature facilitates release from application
- Batteries and charging systems readily available from many sources

AcraDyne[®] XT HIGH TORQUE CORDLESS XT SERIES TOOLS

A Division of AIMCO



ABETP Series Tool with Custom AcraDyne Reaction Bar

Many custom reaction devices are available. Contact an AIMCO Customer Service Associate for more details, 1-503-254-6600, or toll free 1-800-852-1368.



Digital Display and Control Interface

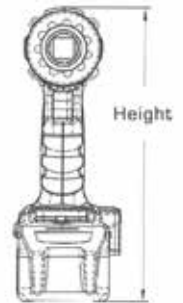
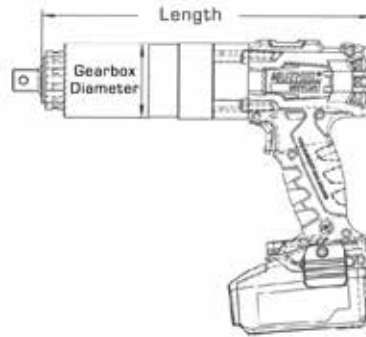

AcraDyne Cordless XT Series Tools

Model*	Torque Range**		Drive Size		Length		Height		Gearbox Dia.		Weight		Noise Level dB(A)
	NM	FT-LB	IN	RPM	MM	IN	MM	IN	MM	IN	KG	LB	
ABETP-350 (-KIT-120V)(-KIT-220V)	100 - 350	74 - 258	3/4"	15	206	8.1	267	10.5	68	2.7	2.9	6.4	80
ABETP-500 (-KIT-120V)(-KIT-220V)	150 - 500	110 - 370	3/4"	10	206	8.1	267	10.5	68	2.7	2.9	6.4	80
ABETP-800 (-KIT-120V)(-KIT-220V)	230 - 800	170 - 590	3/4"	6	253	10	267	10.5	68	2.7	3.3	7.3	80
ABETP-1400 (-KIT-120V)(-KIT-220V)	300 - 1,400	220 - 1,030	3/4"	6	253	10	267	10.5	68	2.7	3.3	7.3	80
ABETP-1700 (-KIT-120V)(-KIT-220V)	550 - 1,700	405 - 1,250	1"	4	328	12.9	267	10.5	78	3.1	5.3	11.7	80
ABETP-2800 (-KIT-120V)(-KIT-220V)	700 - 2,800	515 - 2,065	1"	3.5	316	12.4	267	10.5	78	3.1	5.8	12.8	80
ABETP-3100 (-KIT-120V)(-KIT-220V)	900 - 3,100	664 - 2,285	1"	2.5	316	12.4	267	10.5	78	3.1	5.8	12.8	80
ABETP-3500 (-KIT-120V)(-KIT-225V)	350 - 3,500	258 - 2,582	1"	2	312	12.3	267	10.5	82	3.2	6.1	13.4	80
ABETP-4000 (-KIT-120V)(-KIT-220V)	810 - 4,000	595 - 2,950	1"	2	312	12.3	267	10.5	82	3.2	6.1	13.4	80
ABETP-4500 (-KIT-120V)(-KIT-220V)	1200 - 4,450	885 - 3,282	1"	2	370	14.6	267	10.5	86	3.4	8.1	17.9	80

* Base model comes with no battery. Base model includes tool and standard reaction bar. Batteries are available separately or in tool/kits combinations.

**Tools should be sized to be used at no more than 80% of their maximum torque capability.

Add "-KIT" to the end of the model number to order a tool kit, which includes 1 tool, 2 batteries, and 1 battery charger. The part number must also specify "120V" or "220V" depending on power requirements.



18V Li-Ion Battery
625368000



Battery Charger
120V: 627046000
220V: 627044000

Li-Ion HD BATTERY AND CHARGER

- 5.5 Ah 18V Li-Ion battery
- LiHD battery provides ultimate performance and extremely long use with minimal temperature variation
- Air cooled charging technology: Battery pack cools during charging, significantly reducing charging times
- Processor-controlled charge and discharge management
- Battery can be stored with almost no self-discharge

DynaTorque MANUAL TORQUE MULTIPLIERS

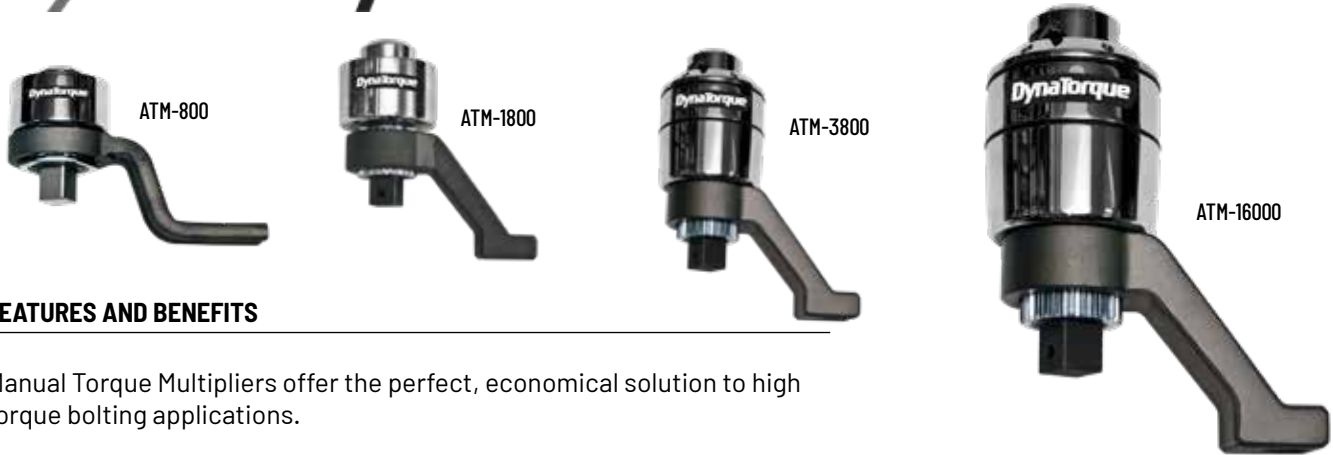

FEATURES AND BENEFITS

Manual Torque Multipliers offer the perfect, economical solution to high torque bolting applications.

- Superior power to weight ratio
- Delivered torque accuracy +/- 4%
- Anti-Wind Up safety feature (2,800 NM models and up) prevents input device from springing backward when released
- True torque multiplication ratios
- Standard reaction arms supplied. Custom reaction arms/nose extensions available to suit specific applications
- No preventative maintenance required
- Overload protected by shear-drive design (spare torsion shaft included). Easily replace sheared-off pins at the work site

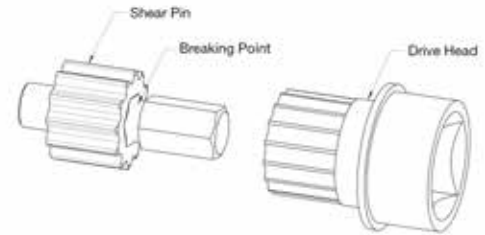

DynaTorque Manual Torque Multipliers

Model	Input IN	Output IN	Ratio	Max Torque Output		A (MM)	B (MM)	C (MM)	D (MM)	Weight*	
				Nm	Ft-Lb					LB	KG
ATM-800	1/2	3/4	1:3.5	800	590	65	105	132	130	2.9	1.3
ATM-1800	3/4	1	1:3.6	1,800	1,327	90	150	188	132	6.6	3.0
ATM-2800	1/2	1	1:13	2,800	2,066	95	200	240	132	11.5	5.2
ATM-3800	3/4	1	1:13	3,800	2,804	95	200	240	132	11.5	5.2
ATM-5000	3/4	1.5	1:17	5,000	3,690	120	215	272	150	15.4	7.0
ATM-8000	3/4	1.5	1:49	8,000	5,904	132	268	344	200	25.4	11.5
ATM-12000	3/4	1.5	1:58	12,000	8,856	156	272	348	200	30.9	14.0
ATM-16000	3/4	2.5	1:75	16,000	11,808	215	292	370	225	57.3	26.0

* Weight shown does not include weight of reaction device.

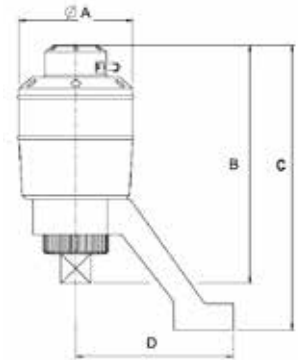

CARRYING CASE

All DynaTorque Multipliers are supplied in a rugged, weather-resistant, portable carrying case.



SOCKETS

In addition to the models presented below, a wide variety of sockets and extensions are available. Contact an AIMCO Customer Service Associate for details, 1-503-254-6600, or toll free 1-800-852-1368.

IMPACT SOCKETS

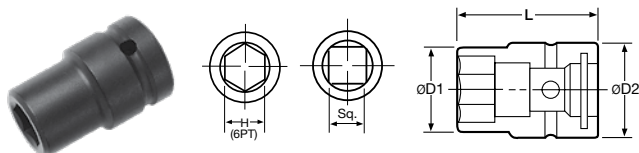

	Part No	Hex	D1 MM	D1 IN	D2 MM	D2 IN	L MM	L IN
3/4" Square Drive								
SAE	A611/16	11/16"	30	1.18	44	1.73	50	1.97
	A63/4	3/4"	32	1.26	44	1.73	50	1.97
	A613/16	13/16"	35	1.38	44	1.73	50	1.97
Metric	A614	14 mm	24	0.95	38	1.50	55	2.17
	A616	16 mm	27	1.06	44	1.73	50	1.97
	A617	17 mm	30	1.18	38	1.50	55	2.17
3/4" Square Drive, Deep								
SAE	A611/16-4	11/16"	31	1.22	44	1.73	100	3.94
	A63/4-4	3/4"	33	1.30	44	1.73	100	3.94
	A613/16-4	13/16"	36	1.42	44	1.73	100	3.94
Metric	A617-4	17 mm	31	1.22	44	1.73	100	3.94
	A618-4	18 mm	32	1.26	44	1.73	100	3.94
	A619-4	19 mm	33	1.30	38	1.50	100	3.94
1" Square Drive								
SAE	A87/8	7/8"	37	1.46	54	2.13	59	2.32
	A815/16	15/16"	38	1.50	54	2.13	59	2.32
	A81	1"	41	1.61	54	2.13	59	2.32
Metric	A817	17 mm	31	1.22	50	1.97	63	2.48
	A819	19 mm	33	1.30	50	1.97	63	2.48
	A821	21 mm	37	1.46	50	1.97	63	2.48
1-1/2" Square Drive								
SAE	A142-1/8	2-1/8"	84	3.31	84	3.31	87	3.43
	A142-1/2	2-1/2"	97	3.82	86	3.39	100	3.94
	A143-1/2	3-1/2"	130	5.12	86	3.39	120	4.72
Metric	A144-1/4	4-1/4"	155	6.10	102	4.02	140	5.51
	A1465	65 mm	99	3.90	86	3.39	100	3.94
	A1475	75 mm	112	4.41	86	3.39	110	4.33
SAE	A1485	85 mm	125	4.92	86	3.39	120	4.72
	A14105	105 mm	151	5.95	102	4.02	130	5.12
	2-1/2" Square Drive							
SAE	A242-3/8	2-3/8"	100	3.94	137	5.39	130	5.12
	A242-3/4	2-3/4"	110	4.33	137	5.39	130	5.12
	A243-1/4	3-1/4"	130	5.12	137	5.39	130	5.12
Metric	A243-7/8	3-7/8"	148	5.83	137	5.39	140	5.51
	A2460	60 mm	100	3.94	137	5.39	130	5.12
	A2480	80 mm	125	4.92	137	5.39	130	5.12
	A24110Z	110 mm	162	6.38	137	5.39	150	5.91
	A24150	150 mm	219	8.62	160	6.30	170	6.69

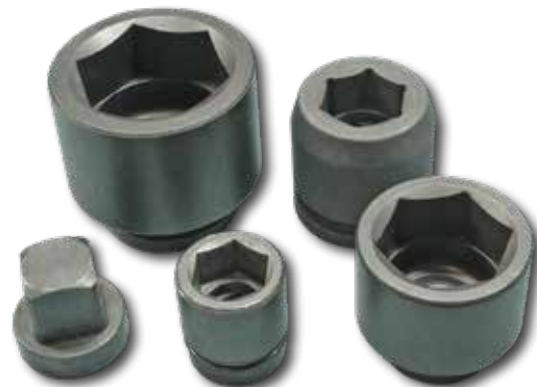

ALLEN SOCKETS

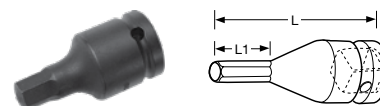

Part No	Hex	L1 MM	L1 IN	L MM	L IN
1-1/2" Allen Socket					
A1432CZ	32 mm	20.5	1.26	120	4.72

Many other allen sockets are available, including:

- 1" x 19 mm 1-1/2 x 19 mm
- 1" x 22 mm 1-1/2 x 22 mm
- 1" x 24 mm 1-1/2 x 24 mm
- 1" x 27 mm 1-1/2 x 36 mm

Contact an AIMCO Customer Service Associate for ordering options, 1-503-254-6600, or toll free 1-800-852-1368.

EXTENSIONS

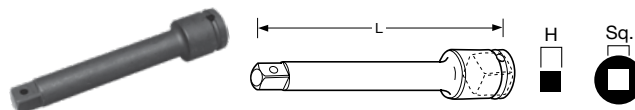

Part No	Sq Drive	Hex	L MM	L IN	D MM	D IN
A610E	3/4"	3/4"	100	3.94	44	1.73
A810E	1"	1"	102	4.02	54	2.13
A1220E	1-1/4"	1-1/4"	200	7.87	60	2.36
A1418E	1-1/2"	1-1/2"	178	7.01	84	3.31
A2426E	2-1/2"	2-1/2"	264	10.39	137	5.39

SOCKET ADAPTERS

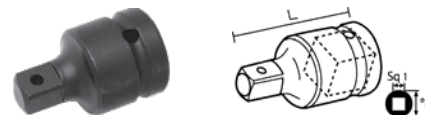

Part No	Female Sq. Drive	Male Sq. Drive	D MM	D IN	L MM	L IN
A604A	3/4"	1/2"	38	1.50	53	2.09
A806A	1"	3/4"	50	1.97	70	2.76
A128A	1-1/4"	1"	60	2.36	76	2.99
A#508A	Spline #5	1"	60	2.36	90	3.54

SOCKETS

ERGO-DRIVE SOCKETS

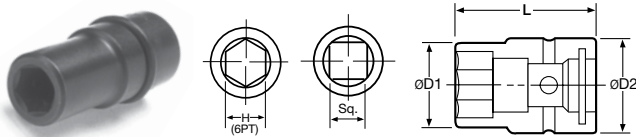

Part No	Hex	D1 MM	D1 IN	D2 MM	D2 IN	L MM	L IN
3/4" Square Drive							
A61-1/8EDS	1-1/8"	44	1.73	44	1.73	64	2.52
A61-1/4EDS	1-1/4"	49	1.91	44	1.73	66	2.60
A61-1/2EDS	1-1/2"	57	2.24	44	1.73	68	2.68
A618EDS	18 mm	31	1.22	44	1.73	60	2.36
A624EDS	24 mm	40	1.52	40	1.73	65	2.36
1" Square Drive							
A815/16EDS	15/16"	38	1.50	54	2.13	69	2.72
A8100EDS	100 mm	136	5.35	76	2.99	120	4.72

ERGO-DRIVE EXTENSIONS

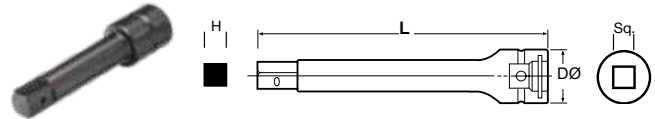

Part No	Sq Drive	H	L MM	L IN	D MM	D IN
3/4" Square Drive						
A676EDE	3/4"	3/4"	76	2.99	40	1.58
A6100EDE	3/4"	3/4"	100	3.94	40	1.58
A6150EDE	3/4"	3/4"	150	5.91	40	1.58
A6200EDE	3/4"	3/4"	200	7.87	40	1.58

1" Square Drive						
A8150EDE	1"	1"	150	5.91	54	2.13
A8200EDE	1"	1"	200	7.87	54	2.13

CUSTOM BITS, SOCKETS, AND EXTENSIONS FOR THE POWER TOOL USER

AIMCO can provide specials for virtually any application. From design to delivery, AIMCO's quick response ensures high quality, tight tolerance specials.

Specials are available in every style including:

- Deep Socket
- Extended Socket
- Universal
- Allen Head
- Torx Head
- Socket Adapter
- Nut Runner Socket
- Nut Runner Joint
- Nutsetter
- Magnetic Nutsetter
- Universal Nutsetter
- Screwdriver Bits



Contact an AIMCO Customer Service Associate at 1-503-254-6600, or toll free 1-800-852-1368.

HT ACCESSORIES

ACCESSORIES

Custom accessories are available for your application; contact an AIMCO Customer Service Associate for details, 1-503-254-6600, or toll free 1-800-852-1368.



Model	Description
26477	Swivel Bail, 6000 Series
26327	Swivel Bail, 7000 Series
25287	Swivel Bail, 8000 Series
26630	Swivel Bail, 8000/9000 Series Tools
26478	Swivel D-Handle, 6000 Series
26328	Swivel D-Handle, 7000 Series
25291	Swivel D-Handle, 8000 Series
26479	Stationary Bail, 6000 series (26336 handle not included)
26332	Stationary Bail, 7000 series (26336 handle not included)
25289	Stationary Bail, 8000 series (26336 handle not included)
26336	Fixed Handle (for use with 26479, 26332, 25289)
26337	Rear Fixed Hoist Ring, 6000/7000/8000 Series Pistols
28514	Rear Folding Hoist Ring Kit for 8000 Series Pistols
28549	Sliding Spindle, 6000 Series
27045	Sliding Spindle, 7000 Series
30300	Sliding Spindle, 8000 Series

REACTION BARS



HT tool includes a standard, spline attachment reaction device. Custom reaction devices are available. Contact an AIMCO Customer Service Associate for more details, 1-503-254-6600, or toll free 1-800-852-1368.

	Model	Description
Single Ended Flat	26810	6000 Series
	26800	7000 Series
	25277	8000 Series
	27255	9000 Series
	30303	X Series
Single Ended Offset	26815	2.375" Offset, 6000 Series
	26885	4.00" Offset, 6000 Series
	27200	3.10" Offset, 7000 Series
	26890	4.00" Offset, 7000 Series
	25274	3.35" Offset, 8000 Series
	25275	4.00" Offset, 8000 Series
	26840	3.35" Offset, 9000 Series
	30306	5.00" Offset, X Series
31273	5.00" Offset, Y Series	
Double Ended Flat	26830	6000 Series
	26820	7000 Series
	25278	8000 Series
Double Ended Offset	25276	3.35" Offset, 8000 Series

HEAVY DUTY WATER-RESISTANT CASE FOR HT TOOLS



Case with molded foam insert

Made of ultra high-strength polypropylene copolymer resin, this water resistant utility case protects AcraDyne HT tools.

- Molded-in hinge, trigger-release latch system, and snap-down cushion grip handle
- Resistance to UV, solvents, corrosion, and impact damage

PROTECTIVE COVERS

Durable protective covers prevent marring and damage.



Model	Description
BJ10078	Protective Cover, 6000 Series
BJ10077	Protective Cover, 7000 Series
BJ10076	Protective Cover, 8000 Series

Model	Compatible Tools	Description
CC-6000-F	6000 series	Case with molded foam insert
CC-6000-FIP	6000 series	Case with foam in place
CC-7000-F	7000 series	Case with molded foam insert
CC-7000-FIP	7000 series	Case with foam in place
CC-8000-F	8000 series	Case with molded foam insert
CC-8000-FIP	8000 series	Case with foam in place

Please contact an AIMCO Customer Service Associate for details, 1-503-254-6600, or toll free 1-800-852-1368.

HT ACCESSORIES

CABLE ASSEMBLIES

The AcraDyne DC electric nutrunner tool system uses a single cable to carry all necessary conductors for superior ergonomics and durability.



- Flexible polyurethane cover for maximum durability, abrasion and transmission fluid resistant
- Quick disconnects at both ends facilitate tool changeover and troubleshooting
- The CAN data/signal is via RJ45 for products such as the KDM socket tray or computer



24330
Standard Tool Cable

Model	Description	Length	
		M	Ft
Tool Cables			
24330	G3/G4 Tool Cable 3M	3	9.8
25350	G3/G4 Tool Cable 5M	5	16.4
24320	G3/G4 Tool Cable 10M	10	32.8
Extensions			
24320	Extension cable 10M	10	32.8
25518	Extension cable 20M	20	65.6

CABLE ADAPTERS AND CONNECTORS

	Model	Description
Adapters and Connectors		
	26364	G3/G4 Right Angle Cable Adapter
	25491	G3/G4 Breakaway Cable Connector - Ensures disconnect of cable should stress in excess of 40 lbs. occur (see below)

BREAKAWAY CABLE CONNECTOR

Innovative Quick Disconnect Device reduces cable damage from dropping tools or pulling cables when in use.



25491
Breakaway Cable Connector

- Easily snaps into place, using magnetic force, at either the tool or the controller
- Adjust holding force by removing or adding magnets. Max holding force is 40 lbs / 18 kg

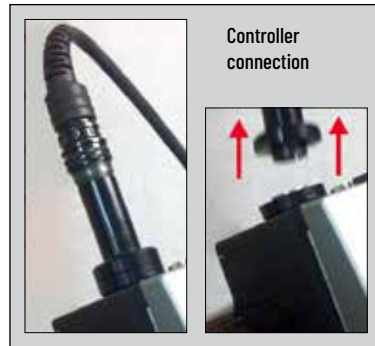

AHCTS TEST STAND FOR ROTATING TOOLS



AHCTS-5000

Designed for testing tools with continuous rotating output spindles. The test stand includes a rundown fixture, bushing for side load support, reaction post or reaction paddles, transducer, and torque analyzer display.

Model	Rundown Fixture Capacity	Description
AHCTS-2500	250 ft-lbs - 2,500 ft-lbs 340 Nm - 3,390 Nm	1.5" Sq. Dr. w/rundown fixture*
AHCTS-5000	500 ft-lbs - 5,000 ft-lbs 678 Nm - 6,780 Nm	1.5" Sq. Dr. w/rundown fixture*
AHCTS-7500	750 ft-lbs - 7,500 ft-lbs 1,016 Nm - 10,168 Nm	1.5" Sq. Dr. w/rundown fixture

*Adapters for 3/4" drive and 1" drive are available. Consult your AcraDyne HT representative for details, 1-503-254-6600, or toll free 1-800-852-1368.

HT ACCESSORIES

PORTABLE RUNDOWN FIXTURE



30955

Eliminate the need for high-cost, heavy, and cumbersome test stands. This portable, lightweight, and easy-to-use rundown fixture requires virtually no set-up and is ideal for tool-run tests up to 1,000 Nm. With a reaction bar attached, run one bolt down to torque while using the second bolt as the reaction point.

FEATURES AND BENEFITS

- Two bolts – one for rundown, one for reaction
- No clamping or securing necessary
- Can be used with medium or hard joint
- Easy to adjust reaction bolt
- Grade 5 bolts provide durability (lithium grease included)
- Rundown fixture includes:
 - A62-1/16Z Socket for 3/4" Sq. Dr. Tools
 - A82-1/16Z Socket for 1" Sq. Dr. Tools
- Recommended:
 - 30951 Grade 5 Replacement Bolt

Model	Max. Torque Capacity	Width		Weight	
	NM	IN	MM	KG	LB
30955	1,000	8.50	215.9	5.6	12.45

When used with recommended AIMCO sockets, reaction bar geometry is a standard offset (2" - 3.5")



HIGH-TORQUE TOOL SPECIALS

AIMCO can provide customized tooling solutions for even the most unique applications. Let us propose a solution tailored to your needs. Contact an AIMCO Customer Service Associate for more details, 1-503-254-6600, or toll free 1-800-852-1368.



AIR LINE ACCESSORIES FOR HT TOOLS

Polyurethane Hose for HT Tools



ASH-500C-15MSZ

- Durable Polyurethane is chemical resistant and lightweight, and provides excellent recoil memory and maximum flexibility
- Available in transparent hose color (opaque also available)
- Assemblies for coiled hose include reusable swivel fitting. Straight hose available with or without fittings
- Working temperature: -104° F to 175° F
- Working pressure: 100 PSI

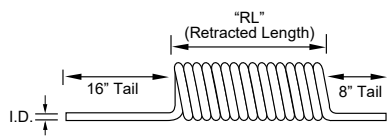

Custom length coil assemblies and special colors available in minimum order quantities. Contact an AIMCO Customer Service Associate, 1-503-254-6600, or toll free 1-800-852-1368.

Single Air Hose Assemblies (Coiled)

Model	Description (O.D. x I.D. x Length)	Retracted Length	Npt Fittings
ASH-500C-15MSZ	3/4" x 1/2" x 15'	13"	1/2"
ASH-500C-25MSZ	3/4" x 1/2" x 25'	23"	1/2"



Straight Air Hose (Sold Per Foot)

MODEL	DESCRIPTION
ASH-500Z	1/2" I.D.

Contact an AIMCO Customer Service Associate about full reel pricing, 1-503-254-6600, or toll free 1-800-852-1368.

Rubber Hose for HT Tools



28796
1/2" ID

- Designed for use in a wide range of industrial, construction, and agricultural applications
- Constructed of high grade, reinforced EPDM synthetic rubber
- Working temperature: -40° F to 190° F

Single Air Hose (Rubber)

I.D.	O.D.	Length	Working Pressure	Weight
1/2"	0.81"	10 ft	200 psi	2.0 lb
5/8"	0.97"	10 ft	200 psi	2.7 lb
3/4"	1.12"	10 ft	200 psi	3.4 lb

Custom lengths available. Contact an AIMCO Customer Service Associate for more details, 1-503-254-6600, or toll free 1-800-852-1368.

HT Air Tool/AFRL Carrying Kit



28178

Complete System Pack including nested FRL. Check with your AIMCO representative for details, 1-503-254-6600, or toll free 1-800-852-1368.

Air Line Fittings



Plugs

Model	Description
28161	1/2" x 1/4" MPT
28162	1/2" x 3/8" MPT
28163	1/2" x 1/2" MPT
28164	1/2" x 1/2" FPT

Quick-Change Couplers

Model	Description
27768	1/2" FPT
27769	1/2" MPT

Protective Coupler

Model	Description
27771	Vinyl

Swivel Fitting

Model	Capacity
500-SZ	1/2" NPT Swivel Fitting

AIR PREPARATION UNITS

AFRL STACKING FILTER/REGULATORS

Stacking filter/regulator combinations provide air filtration and precise regulation in a single unit for easy mounting and installation.

FEATURES AND BENEFITS

- All models include L-mount bracket, gauge, and metal bowl shields
- Polycarbonate filter and lubricator bowls (metal bowls standard on AFRL-8)
- 25-micron filter included on all models
- Regulating range: 7 - 125 PSI
- Custom order upgrade items include metal bowl, 5 micron filter, semi-automatic filter drain, and reduced PSI range regulator. Contact an AIMCO Customer Service Associate for more information, 1-503-254-6600, or toll free 1-800-852-1368



AFRL-2-C
AFRL-3-C

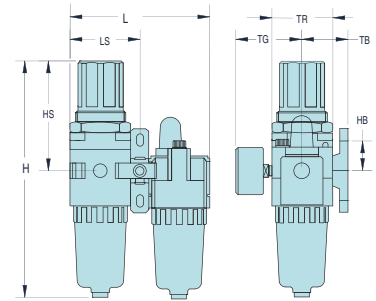

AFRL-3
AFRL-4
AFRL-8

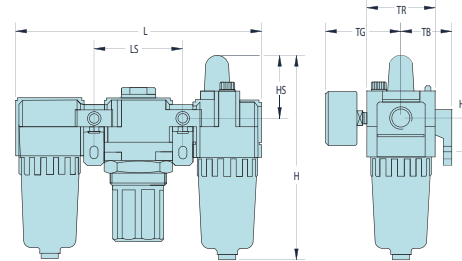

28178
HT Air Tool/AFRL
Carrying Kit



AFRL-4HTA
Standalone Unit

AFRL Stacking Filter/Regulators

Model	Port	Gauge Port	Flow Rate CFM	Flow Rate L/MIN	Bowl Shield	H IN/MM	HB IN/MM	HS IN/MM	L IN/MM	LS IN/MM	TB IN/MM	TG IN/MM	TR IN/MM
AFRL-2	1/4"	1/8"	70	2,000	yes	6.16 (156.5)	1.39 (35.3)	1.50 (38.1)	7.13 (181.1)	2.52 (64.0)	1.61 (41.0)	2.39 (60.7)	2.09 (53.1)
AFRL-2-C	1/4"	1/8"	60	1,700	yes	8.31 (211.1)	1.38 (35.1)	3.64 (92.5)	4.61 (117.1)	2.30 (58.4)	1.61 (40.9)	2.39 (60.7)	2.09 (53.1)
AFRL-3	3/8"	1/4"	140	4,000	yes	7.54 (191.5)	1.57 (40.0)	1.61 (40.9)	9.37 (238.0)	3.31 (84.1)	1.97 (50.0)	2.58 (65.5)	2.76 (70.1)
AFRL-3-C	3/8"	1/4"	105	3,000	yes	10.31 (261.9)	1.57 (39.9)	4.41 (112.0)	6.06 (153.9)	3.03 (77.0)	1.97 (50.0)	2.58 (65.5)	2.76 (70.1)
AFRL-4	1/2"	1/4"	140	4,000	yes	7.54 (191.5)	1.57 (40.0)	1.61 (40.9)	9.37 (238.0)	3.31 (84.1)	1.97 (50.0)	2.58 (65.5)	2.76 (70.1)
AFRL-8	1"	1/4"	180	5,000	yes	10.69 (271.5)	1.97 (50.0)	1.89 (48.0)	11.81 (300.0)	4.13 (104.9)	2.75 (69.9)	2.97 (75.4)	3.54 (89.9)

Air Preparation Units: Basic Functions

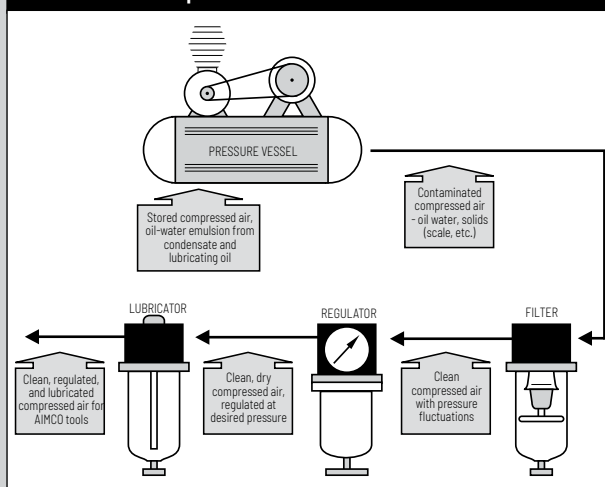

The supply of clean, dry air is essential to the operation of pneumatic powered tools. Use only clean filtered air for longer tool life. Provide proper airflow (CFM) and regulate air pressure (PSI) for optimum performance.

To determine unit size for application, you need to know:

- Total air flow (CFM) required for application
- Size of incoming air line and size of air line required by tool
- Air supply pressure (PSI)
- Allowable pressure drop
- Does the application require lubrication?
- Does the overall system have the required capacity?

INDEX

MODEL #	PAGE	MODEL #	PAGE	MODEL #	PAGE	MODEL #	PAGE	MODEL #	PAGE
A									
A128A	22	AAP1B66600A	17	AEJ4U 9000 Series HTXD Tools . . .	11	ASH-500C-25MSZ	27	26477	24
A142-1/2	22	AAP1B66850A	17	AEJ4W 9X Series HTXD Tools . . .	11	ASH-500Z	27	26478	24
A142-1/8	22	AAP1B76950A	17	AEJ4W 9Y Series HTXD Tools . . .	11	ATM-800	21	26479	24
A143-1/2	22	AAP1B771350A	17	AEJ4W 8000 Series HT Tools . . .	4	ATM-1800	21	26630	24
A144-1/4	22	AAP1B772000A	17	AEJ4W 9000 Series HTXD Tools . . .	11	ATM-2800	21	26800	24
A1220E	22	AAP1B772950A	17	AEN3 5000 Series HT		ATM-3800	21	26810	24
A1418E	22	AAP1B885100A	17	Angle Tools	5	ATM-5000	21	26815	24
A1432CZ	22	AAP2B76250A(R)	18	AEN4B 7000 Series HT		ATM-8000	21	26820	24
A1465	22	AAP2B76450A(R)	18	Angle Tools	7	ATM-12000	21	26830	24
A1475	22	AAP2B76650A(R)	18	AEP4A 6000 Series HT		ATM-16000	21	26840	24
A1485	22	AAP2B76950A(R)	18	Dual-Lever Tools	9	AXD-2000	12	26885	24
A14105	22	AAP2B771400A(R)	18	AEP4A 6000 Series HT Tools . . .	3	AXD-2000B	12	26890	24
A2426E	22	AAP2B772000A(R)	18	AEP4A 7000 Series HT				27045	24
A#508A	22	AAP2B773000A(R)	18	Dual-Lever Tools	9			27200	24
A61-1/2EDS	23	AAP2B785100A(R)	18	AEP4A 7000 Series HT Tools . . .	3			27255	24
A61-1/4EDS	23	ABETP Cordless XT Series	20	AEP4A 8000 Series HT				27768	24
A61-1/8EDS	23	ABP-CTA Ultra Torque Cordless		Dual-Lever Tools	9			27769	27
A63/4	22	Pistol Tools	13	AEP4A 8000 Series HT Tools . . .	3			27771	27
A63/4-4	22	ABP-MTA04(O)(W)(BO)(WBO) . . .	26	AEP4B 6000 Series HT Tools . . .	4			28050	16
A604A	22	AED4A 6000 Series HT Tools . . .	3	AEP4B 7000 Series HT				28161	27
A610E	22	AED4A 7000 Series HT Tools . . .	3	Dual-Lever Tools	9			28162	27
A611/16	22	AED4A 8000 Series HT Tools . . .	3	AEP4B 7000 Series HT Tools . . .	4			28163	27
A611/16-4	22	AED4B 6000 Series HT Tools . . .	4	AEP4B 8000 Series HT				28164	27
A613/16	22	AED4B 8000 Series HT Tools . . .	4	Dual-Lever Tools	9			28178	17, 27, 28
A613/16-4	22	AED4W 8000 Series HT Tools . . .	4	AEP4B 8000 Series HT Tools . . .	4			28480	16
A614	22	AEF4A 6000 Series HT		AEP4B 9000 Series HT Tools . . .	4			28514	24
A616	22	Dual-Lever Tools	9	AEP4W 9X Series HTXD Tools . . .	11			28549	24
A617	22	AEF4A 6000 Series HT Tools . . .	3	AEP4W 9Y Series HTXD Tools . . .	11			28796	27
A617-4	22	AEF4A 7000 Series HT		AEP4W 8000 Series HT Tools . . .	4			30300	24
A618-4	22	Dual-Lever Tools	9	AEP4W 9000 Series HTXD Tools . .	11			30303	24
A618EDS	23	AEF4A 7000 Series HT Tools . . .	3	AES4A 6000 Series HT				30306	24
A619-4	22	AEF4A 8000 Series HT		Dual-Lever Tools	9			31273	24
A624EDS	23	AEF4B 6000 Series HT		AES4A 6000 Series HT Tools . . .	3			500-SZ	27
A676EDE	23	Dual-Lever Tools	9	AES4A 7000 Series HT					
A6100EDE	23	AEF4B 7000 Series HT		Dual-Lever Tools	9				
A6150EDE	23	AEF4B 8000 Series HT		AES4A 8000 Series HT Tools . . .	3				
A6200EDE	23	Dual-Lever Tools	9	AES4B 6000 Series HT					
A81	22	AEF4B 8000 Series HT		Dual-Lever Tools	9				
A87/8	22	AEF4A 8000 Series HT		AES4B 7000 Series HT					
A806A	22	Dual-Lever Tools	9	Dual-Lever Tools	9				
A810E	22	AEFJA 8000 Series HT		AFRL-4	17, 28				
A815/16	22	AEJ4A 6000 Series HT Tools . . .	3	AFRL-4HTA	17, 28				
A815/16EDS	23	AEJ4A 7000 Series HT Tools . . .	3	AFRL-2	28				
A817	22	AEJ4A 8000 Series HT Tools . . .	3	AFRL-2-C	28				
A819	22	AEJ4B 6000 Series HT Tools . . .	4	AFRL-3	28				
A821	22	AEJ4B 7000 Series HT Tools . . .	4	AFRL-3-C	28				
A8100EDS	23	AEJ4B 8000 Series HT		AFRL-8	28				
A8150EDE	23	Dual-Lever Tools	9	AHCTS-2500	25				
A8200EDE	23	AEJ4B 8000 Series HT Tools . . .	4	AHCTS-5000	25				
AAP1B66400A	17	AEJ4U 9X Series HTXD Tools . . .	11	AHCTS-7500	25				
		AEJ4U 9Y Series HTXD Tools . . .	11	ASH-500C-15MSZ	27				



APPLICATIONS



PETROCHEM

- Reactor
- Cracker
- Heat-Exchanger
- Valves, Pumps
- Compressors
- Heaters



COMPRESSOR STATION

- Tie Rod
- Engines
- Compressors
- Turbines
- Pipe-Line
- Well Heads



STEEL MILL

- Sintering
- Blast Furnace
- Hot Strip
- Cold Roll
- Central Machine
- Pipe Shop



WIND TURBINE

- Tower Bolts
- Foundation Bolts
- Bearing Housing
- Shrink Disc
- Gear Mount
- Hub Bearing



OFFSHORE

- Diesel Engine
- Mud Pump
- Crane
- Vessel Thruster
- Stacks



POWER

- Steam Turbine
- Gas Turbine
- Hydro Turbine
- Comb. Cycle
- Valves, Pumps, Reactors, Pipes



MINING

- Shovel & Drill
- Ball Mill
- Long-Wall
- Hoist
- Car Carrier



WWW.AIMCO-GLOBAL.COM

CORPORATE HEADQUARTERS

10000 SE Pine Street
Portland, Oregon 97216
Phone: (503) 254-6600
Toll Free: 1-800-852-1368

AIMCO CORPORATION DE MEXICO SA DE CV

Ave. Cristobal Colon 14529
Chihuahua, Chihuahua. 31125
Mexico
Phone: (01-614) 380-1010
Fax: (01-614) 380-1019