

AcraDyne®

HIGH CAPABILITY TOOLING

The Most Advanced Collection of Controlled Tools Anywhere



For over 40 years AIMCO has been working with manufacturers around the world, we are the complete global source for all assembly, fastening, and critical bolting needs. AIMCO can effectively and swiftly meet your needs whether you're in Thailand fastening a 3 mm nut at 3 Nm, or in Tennessee, USA torquing the last lug nut. AIMCO provides the tools and solutions, on a global scale, that guarantee the success of your project. It is with great pride that AIMCO can say the products that we manufacture are **MADE IN THE USA.**

ISO 9001: 2015 Certified

Visit our NEW website www.aimco-global.com

TABLE OF CONTENTS

ACRADYNE®

GEN IV CONTROLLER	4-6
CONTROLLER SOFTWARE	7
1000 SERIES NUTRUNNERS	8-9
1000, 2000 & 5000 SERIES PISTOL GRIP NUTRUNNERS	10-11
2000, 3000 & 5000 SERIES ANGLE / INLINE NUTRUNNERS.	12-15
5000 SERIES FIXTURED NUTRUNNERS.	16
TUBENUT NUTRUNNERS AND SPECIALTY GEARHEADS.	17
HOLD & DRIVE NUTRUNNERS	18
MID-EXIT CABLE NUTRUNNERS	19
RIV-NUT NUTRUNNERS	20
HT SERIES D/C TOOLS.	21
HT SERIES D/C ANGLE TOOLS.	22
HT SERIES DUAL LEVER AND GEARHEAD TOOLS.	23
HT SERIES NOSE EXTENSIONS AND ACCESSORIES.	24
TOOL / SPINDLE SELECTION GUIDE	26-27
ACCESSORIES.	28-30
HT SERIES PNEUMATIC TOOLS.	31
HT SERIES PNEUMATIC TOOL ACCESSORIES.	32
AIR PREPARATION UNITS	33
ACRADYNE® SYSTEMS	34

AUDITOR™

TORQUE MEASUREMENT: OVERVIEW	35-37
TORQUE MEASUREMENT SYSTEMS	38
TORQUE MEASUREMENT TESTERS	39-41
TORQUE MEASUREMENT ANALYZERS	42-47
TOOL MANAGER / AUDIT MANAGER	48
HIGH-CAPACITY TEST STANDS.	49-51
AUDITOR TORQUE WRENCHES.	52-55
SCS TORQUE WRENCHES	56-59
TORQUE CARTS	60-61
DATA COLLECTION SOFTWARE.	62-63
TRANSDUCERS	64-65
RUNDOWN FIXTURES / JOINT SIMULATORS.	66-68
TORQUE MEASUREMENT CABLES	69
APPENDICES	70-73
INDEX	74

AIMCO



* **E** logo indicates where ERGO-DRIVE sockets/extensions benefit tool operation.

ERGO-DRIVE sockets are uniquely designed to seat deeper on the tool anvil while an O-ring inside the socket fits tight onto the anvil to reduce vibration. By reducing run-out and vibration, ERGO-DRIVE sockets allow the most repeatable, accurate rundowns, ensuring excellent product quality, longer tool life, and better ergonomics for the tool user.

Look for the ERGO-DRIVE **E** logo in this catalog to see where ERGO-DRIVE sockets/extensions benefit tool operation, operator, and rundown.

ACRADYNE® GEN IV CONTROLLER



GEN IV CONTROLLER

The AcraDyne Gen IV controller is the culmination of more than 40 years of serving our industrial fastening customers with 15 years of designing and manufacturing DC tools that are Made in the USA. It is filled with countless advanced capabilities and features. The Gen IV Controller is the core of the modular AcraDyne DC system. One controller will command any tool in the AcraDyne line from 0.5 Nm to 8100 Nm, all with one cable.

FEATURES AND BENEFITS

- Backward compatible – Works with any Gen III tool from 0.5 Nm – 8100 Nm.
- Bright LED screen – View Torque, Angle, Bolt Count, Parameter Set, Job/Sequence easily from a distance.
- Graphical Screen with on-board software that is the same on all devices
- Web browser based programing – Receive data on your PC, Tablet, SmartPhone, or any other web-capable device. You can use more than one device at a time: Be in program mode on one device while reviewing real-time curves on another while watching tool diagnostics on a third.
- Multiple Fastening Strategies – Program up to 256 Parameters with as many as 20 Steps.
- Jobs Capability – 99
- Backup & Restore through USB or Ethernet.
- Removable Flash Memory
- Assignable I/O (8 X 8)
- Rundown storage – 1,000,000
- Curve storage – 10,000
- Event log – 5,000
- Real-time curve viewing
- Programmable Calibration and Service alerts.
- Top exit tool cable option available.



NETWORKING CAPABILITIES

- Ethernet Protocols including Open Protocol, Ethernet/IP & PFCS
- Modular field bus connectivity: PROFIBUS, DeviceNET, Modbus TCP, or any Fieldbus offered by 
- Data collection
- Serial protocols and string output
- Bar Code Scanning & printing
- Multi-spindle synchronization

ACRADYNE® GEN IV CONTROLLER

Four Digit Torque Display

Secondary Display

Allows user to easily set and toggle through information:

- Angle
- Engineering Units
- Bolt Count
- Job/Job Sequence

Optional 7" Graphical Display

- Runs the same software on PC for ease of use.
- Real Time Graphing for Application Review.
- Selectable Run Screens.
- Touch-screen



LED Display

Large numbers can be seen from a distance.

Parameter Set Display

Displays current parameter set and enables user to quickly change by scrolling up or down.

iEC4EGD

MODEL	SYSTEM PORT & REMOVABLE MEMORY	LIGHTS (L) LED DISPLAY (D) GRAPH (G)	24V I/O ASSIGNABLE 8 X 8"	SERIAL PORT WITH PROTOCOLS	BACKUP & RESTORE (USB)	ETHERNET*	DEVICENET	PROFIBUS
iEC4E	X	L/D		X	X	X		
iEC4EV(T)	X	L/D	X	X	X	X		
iEC4EG(T)	X	L/D/G		X	X	X		
iEC4EGV(T)	X	L/D/G	X	X	X	X		
iEC4ED	X	L/D		X	X	X	X	
iEC4EP	X	L/D		X	X	X		X
iEC4EVD	X	L/D	X	X	X	X	X	
iEC4EVP(T)	X	L/D	X	X	X	X		X
iEC4EGD	X	L/D/G		X	X	X	X	
iEC4EGP	X	L/D/G		X	X	X		X
iEC4EGVD	X	L/D/G	X	X	X	X	X	
iEC4EGVP	X	L/D/G	X	X	X	X		X

* Ethernet channel supports The Open Protocol, Toolsnet, EtherNet/IP, Modbus/TCP, and other protocols.
Add (-T) to model number for top exit tool cable option

ACRADYNE® GEN IV CONTROLLER

NETWORK CONNECTIVITY



DIMENSIONS

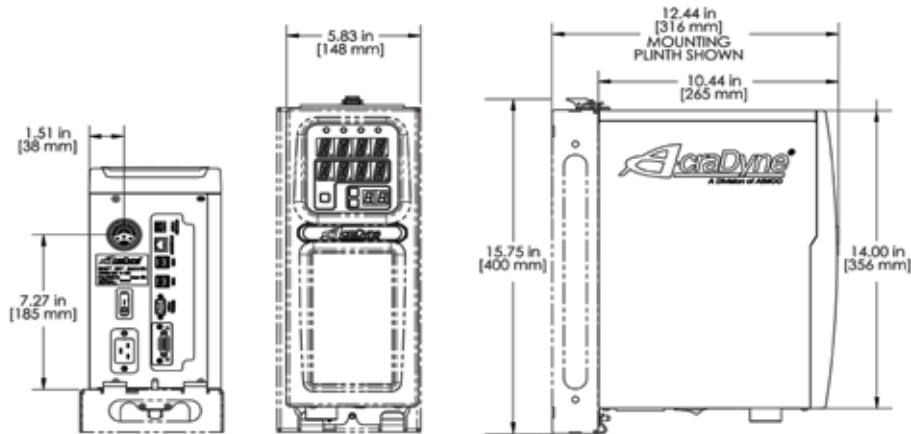

WIDTH	HEIGHT	DEPTH	WEIGHT
5.83 in / 148 mm	15.75 in / 400 mm	12.44 in / 316 mm	15.65 lbs / 7.1 kg

SOFTWARE

AcraDyne's software package is on-board every AcraDyne controller and is provided FREE of charge. This comprehensive, user-friendly program allows programming, analysis, and diagnostics.

The software is based on a standard web browser. This allows you to connect the AcraDyne controller with any computer, tablet, or smart device. Connect through Ethernet, USB, or wirelessly via a network to which both devices are connected.



Adding and editing Parameter Sets (256) and Jobs (99) is easy and intuitive in the parameter set up function



View curve results in real time or one of the up to 10000 stored in memory to program the application for optimal performance

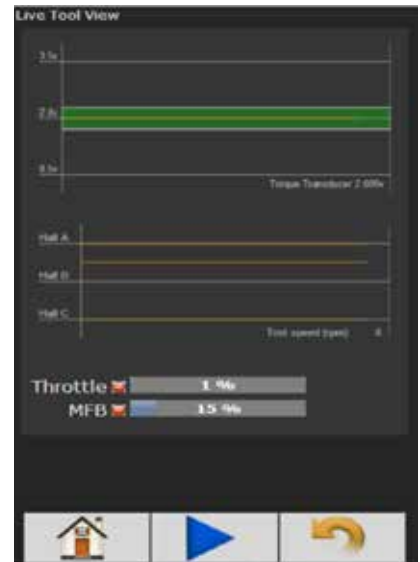

Tool programming and diagnostics for repair, calibration and advanced troubleshooting



Several run screens to choose from. The large screen indicators are helpful in viewing real time results of the rundown from a distance

ACRADYNE® 1000 SERIES NUTRUNNERS

FEATURES AND BENEFITS

Superior -

- Size
- Speed
- Duty Cycle



Angle



Fixtured
Rear Exit Cable



In-line



Fixtured
Bottom Exit Cable



Push-to-Start



APPLICATION DATA

1000 SERIES	NM	MAX TORQUE FT-LB	NM	TORQUE RANGE FT-LB	FREE SPEED RPM	LB	WEIGHT (-) SOCKET	KG	OUTPUT DRIVE
ANGLE*									
AEN4C12004B	4	3	1 - 4	0.7 - 3	3,111	2.0		0.91	1/4 Q.C.
AEN4C12009B	9	6.6	2.3 - 9	1.7 - 6.6	1,750	2.2		1.00	3/8 sq. dr.
AEN4C12014B	14	10	3.5 - 14	2.6 - 10	875	2.2		1.00	3/8 sq. dr.
AEN4C12018B	18	13	4.5 - 18	3.3 - 13	691	2.2		1.00	3/8 sq. dr.
AEN4C12022B	22	16	5.5 - 22	4.1 - 16	560	2.2		1.00	3/8 sq. dr.
IN-LINE**									
AES4A12003B(V)(Q)	3	2.2	0.8 - 3	0.6 - 2.2	2,625	2.0		0.91	3/8 sq. dr.
AES4A12006B(V)(Q)	6	4.4	1.5 - 6	1.1 - 4.4	2,625	2.0		0.91	3/8 sq. dr.
AES4A12011B(V)(Q)	11	8.1	2.8 - 11	2 - 8.1	1,313	2.2		1.00	3/8 sq. dr.
AES4A12014B(V)(Q)	14	10	3.5 - 14	2.6 - 10	1,037	2.2		1.00	3/8 sq. dr.
AES4A12018B(V)	18	13	4.5 - 18	3.3 - 13	840	2.2		1.00	3/8 sq. dr.
AES4A12022B(V)	22	16	5.5 - 22	4.1 - 16	656	2.2		1.00	3/8 sq. dr.
PUSH-TO-START									
AEL4A12003B(Q)	3	2.2	0.8 - 3	0.6 - 2.2	2,625	2.0		0.91	3/8 sq. dr.
AEL4A12006B(Q)	6	4.4	1.5 - 6	1.1 - 4.4	2,625	2.0		0.91	3/8 sq. dr.
AEL4A12011B(Q)	11	8.1	2.8 - 11	2 - 8.1	1,313	2.2		1.00	3/8 sq. dr.
AEL4A12014B(Q)	14	10	3.5 - 14	2.6 - 10	1,037	2.2		1.00	3/8 sq. dr.
AEL4A12018B	18	13	4.5 - 18	3.3 - 13	840	2.2		1.00	3/8 sq. dr.
AEL4A12022B	22	16	5.5 - 22	4.1 - 16	656	2.2		1.00	3/8 sq. dr.
FIXTURED***									
AEF4(A)(C)(X)12003B(B)	3	2.2	0.8 - 3	0.6 - 2.2	2,625	2.0		0.91	3/8 sq. dr.
AEF4(A)(C)(X)12006B(B)	6	4.4	1.5 - 6	1.1 - 4.4	2,625	2.0		0.91	3/8 sq. dr.
AEF4(A)(C)(X)12011B(B)	11	8.1	2.8 - 11	2 - 8.1	1,313	2.2		1.00	3/8 sq. dr.
AEF4(A)(C)(X)12014B(B)	14	10	3.5 - 14	2.6 - 10	1,037	2.2		1.00	3/8 sq. dr.
AEF4(A)(C)(X)12018B(B)	18	13	4.5 - 18	3.3 - 13	840	2.2		1.00	3/8 sq. dr.
AEF4(A)(C)(X)12022B(B)	22	16	5.5 - 22	4.1 - 16	656	2.2		1.00	3/8 sq. dr.

* Add "F" to part numbers for flush socket.

** "V" indicates extended Ergo-Drive output  Replace "V" with "Q" for 1/4" quick change output.

*** Add "A" to part numbers for 1/2" sliding spindle models. Add "C" to part numbers for 1-3/4" sliding spindle models. Add "X" to part numbers for fixed 3/8" square drive output models.

*** Add "B" to part numbers for bottom exit cable.

*  logo indicates where ERGO-DRIVE sockets/extensions benefit tool operation.

ACRADYNE® 1000 SERIES NUTRUNNERS

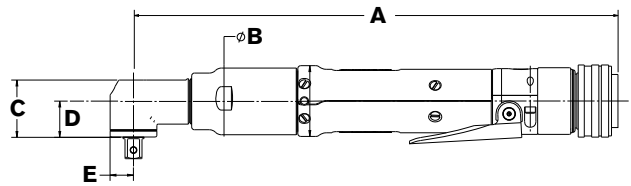

DIMENSIONS

ANGLE	IN	(A)	MM	IN	(B)	MM	IN	(C)	MM	IN	(D)	MM	IN	(E)	MM
AEN4C12004B	11.65		295.9	1.47		37.3	.98		24.8	.62		15.8	.40		10.2
AEN4C12009B	11.00		279.5	1.47		37.3	1.29		32.8	.82		20.9	.52		13.1
AEN4C12014B	11.66		296.4	1.47		37.3	1.29		32.8	.82		20.9	.52		13.1
AEN4C12018B	11.66		296.4	1.47		37.3	1.29		32.8	.82		20.9	.52		13.1
AEN4C12022B	11.66		296.4	1.47		37.3	1.29		32.8	.82		20.9	.52		13.1

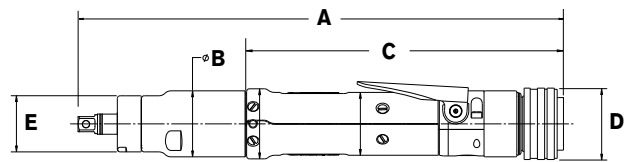

DIMENSIONS

INLINE	IN	(A)	MM	IN	(B)	MM	IN	(C)	MM	IN	(D)	MM	IN	(E)	MM
AES4A12003B	11.12		282.7	1.47		37.3	7.38		187.5	1.59		40.4	1.25		31.8
AES4A12006B	11.12		282.7	1.47		37.3	7.38		187.5	1.59		40.4	1.25		31.8
AES4A12011B	11.44		290.5	1.47		37.3	7.38		187.5	1.59		40.4	1.25		31.8
AES4A12014B	11.44		290.5	1.56		39.6	7.38		187.5	1.59		40.4	1.25		31.8
AES4A12018B	11.44		290.5	1.47		37.3	7.38		187.5	1.59		40.4	1.25		31.8
AES4A12022B	11.44		290.5	1.47		37.3	7.38		187.5	1.59		40.4	1.25		31.8
PUSH-TO-START	IN	(A)	MM	IN	(B)	MM	IN	(C)	MM	IN	(D)	MM	IN	(E)	MM
AEL4A12003B	11.31		287.3	1.56		39.6	7.38		187.5	1.59		40.4	1.25		31.8
AEL4A12006B	11.32		287.4	1.56		39.6	7.38		187.5	1.59		40.4	1.25		31.8
AEL4A12011B	11.62		295.4	1.56		39.6	7.38		187.5	1.59		40.4	1.25		31.8
AEL4A12014B	11.62		295.4	1.56		39.6	7.38		187.5	1.59		40.4	1.25		31.8
AEL4A12018B	11.62		295.4	1.56		39.6	7.38		187.5	1.59		40.4	1.25		31.8
AEL4A12022B	11.62		295.4	1.56		39.6	7.38		187.5	1.59		40.4	1.25		31.8

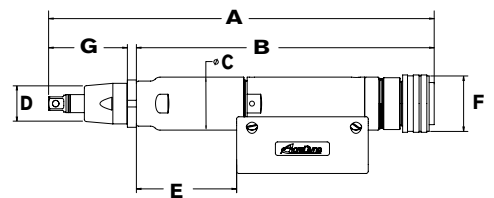

DIMENSIONS

FIXTURED	IN	(A)	MM	IN	(B)	MM	IN	(C)	MM	IN	(D)	MM	IN	(E)	MM	IN	(F)	MM	IN	(G)	MM
AEF4A12003B	11.53		292.9	9.10		231.04	1.47		37.3	1.13		28.57	2.06		52.2	1.59		40.4	2.18		55.5
AEF4A12006B	11.53		292.9	9.10		231.04	1.47		37.3	1.13		28.57	2.06		52.2	1.59		40.4	2.18		55.5
AEF4A12011B	12.20		309.8	9.10		231.04	1.47		37.3	1.13		28.57	2.72		69.1	1.59		40.4	2.18		55.5
AEF4A12014B	12.20		309.8	9.10		231.04	1.47		37.3	1.13		28.57	2.72		69.1	1.59		40.4	2.18		55.5
AEF4A12018B	12.20		309.8	9.10		231.04	1.47		37.3	1.13		28.57	2.72		69.1	1.59		40.4	2.18		55.5
AEF4A12022B	12.20		309.8	9.10		231.04	1.47		37.3	1.13		28.57	2.72		69.1	1.59		40.4	2.18		55.5
AEF4C12003B	15.32		389.2	9.10		231.04	1.47		37.3	1.13		28.57	2.06		52.2	1.59		40.4	5.98		151.8
AEF4C12006B	15.32		389.2	9.10		231.04	1.47		37.3	1.13		28.57	2.06		52.2	1.59		40.4	5.98		151.8
AEF4C12011B	15.99		406.1	9.10		231.04	1.47		37.3	1.13		28.57	2.72		69.1	1.59		40.4	5.98		151.8
AEF4C12014B	15.99		406.1	9.10		231.04	1.47		37.3	1.13		28.57	2.72		69.1	1.59		40.4	5.98		151.8
AEF4C12018B	15.99		406.1	9.10		231.04	1.47		37.3	1.13		28.57	2.72		69.1	1.59		40.4	5.98		151.8
AEF4C12022B	15.99		406.1	9.10		231.04	1.47		37.3	1.13		28.57	2.72		69.1	1.59		40.4	5.98		151.8
AEF4X12003B	9.35		237.5	9.10		231.04	1.47		37.3	1.13		28.57	2.06		52.2	1.59		40.4	.80		20.4
AEF4X12006B	9.35		237.5	9.10		231.04	1.47		37.3	1.13		28.57	2.06		52.2	1.59		40.4	.80		20.4
AEF4X12011B	10.00		254.4	9.10		231.04	1.47		37.3	1.13		28.57	2.72		69.1	1.59		40.4	.80		20.4
AEF4X12014B	10.00		254.4	9.10		231.04	1.47		37.3	1.13		28.57	2.72		69.1	1.59		40.4	.80		20.4
AEF4X12018B	10.00		254.4	9.10		231.04	1.47		37.3	1.13		28.57	2.72		69.1	1.59		40.4	.80		20.4
AEF4X12022B	10.00		254.4	9.10		231.04	1.47		37.3	1.13		28.57	2.72		69.1	1.59		40.4	.80		20.4

ACRADYNE® PISTOL GRIP NUTRUNNERS

FEATURES AND BENEFITS

- Cable configurations available in rear exit, bottom exit, or right angle exit.
- Configured with AcraDyne's multi-function button (MFB) enabling flexibility in operation.
- On-board lights and audible signal for operator feedback.
- Push-To-Start models also available.



Top Exit Cable



Rear Exit Cable



Bottom Exit Cable

APPLICATION DATA

1000 SERIES*	NM	MAX TORQUE	FT-LB	NM	TORQUE RANGE	FT-LB	FREE SPEED RPM	LB	WEIGHT (-) SOCKET	KG	OUTPUT DRIVE
AEP4(A)(R)(T)12003B(V)(Q)	3		2.2	0.8 - 3		0.6 - 2.2	2,625	2.2		1.00	3/8 SQ. DR.*
AEP4(A)(R)(T)12006B(V)(Q)	6		4.4	1.5 - 6		1.1 - 4.4	2,625	2.2		1.00	3/8 SQ. DR.*
AEP4(A)(R)(T)12011B(V)(Q)	11		8.1	2.8 - 11		2 - 8.1	1,313	2.3		1.04	3/8 SQ. DR.
AEP4(A)(R)(T)12014B(V)(Q)	14		10	3.5 - 14		2.6 - 10	1,037	2.3		1.04	3/8 SQ. DR.
AEP4(A)(R)(T)12018BV	18		13	4.5 - 18		3.3 - 13	840	2.3		1.04	3/8 SQ. DR.
AEP4(A)(R)(T)12022BV	22		16	5.5 - 22		4.1 - 16	656	2.3		1.04	3/8 SQ. DR.

2000 SERIES*	NM	MAX TORQUE	FT-LB	NM	TORQUE RANGE	FT-LB	FREE SPEED RPM	LB	WEIGHT (-) SOCKET	KG	OUTPUT DRIVE
AEP4(A)(R)(T)22020BV	20		14	5 - 20		3.7 - 14	1,313	2.4		1.09	3/8 SQ. DR.
AEP4(A)(R)(T)22025BV	25		18	6.3 - 25		4.6 - 18	1,037	2.4		1.09	3/8 SQ. DR.
AEP4(A)(R)(T)22030BV	30		22	7.5 - 30		5.5 - 22	840	2.4		1.09	3/8 SQ. DR.
AEP4(A)(R)(T)22035BV	35		25	8.8 - 35		6.5 - 25	747	2.4		1.09	3/8 SQ. DR.
AEP4(A)(R)(T)22040BV	40		29	10 - 40		7.4 - 29	656	2.4		1.09	3/8 SQ. DR.

* Add "Q" to part numbers for 1/4" quick change output standard
 Add "A" to part numbers for bottom exit cable models,
 Add "R" to part numbers for rear exit cable models,
 Add "T" to part numbers for top exit cable models,

"V" indicates extended Ergo-Drive output **E** Replace "V" with "Q" for 1/4" quick change output.
 Push To Start models available by special order.

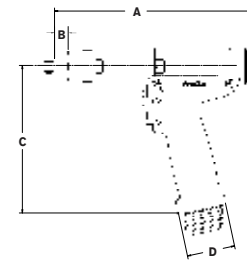

DIMENSIONS

1000 SERIES	IN	(A)	MM	IN	(B)	MM	IN	(C)	MM	IN	(D)	MM
AEP412003BV	7.34		186.3	0.54		13.7	6.01		152.6	1.96		49.7
AEP412006BV	7.34		186.3	0.54		13.7	6.01		152.6	1.96		49.7
AEP412011BV	8.00		203.3	0.54		13.7	6.01		152.6	1.96		49.7
AEP412014BV	8.00		203.3	0.54		13.7	6.01		152.6	1.96		49.7
AEP412018BV	8.00		203.3	0.54		13.7	6.01		152.6	1.96		49.7
AEP412022BV	8.00		203.3	0.54		13.7	6.01		152.6	1.96		49.7

2000 SERIES	IN	(A)	MM	IN	(B)	MM	IN	(C)	MM	IN	(D)	MM
AEP422020BV	8.66		219.9	0.56		14.2	6.87		174.4	1.96		49.7
AEP422025BV	8.66		219.9	0.56		14.2	6.87		174.4	1.96		49.7
AEP422030BV	8.66		219.9	0.56		14.2	6.87		174.4	1.96		49.7
AEP422035BV	8.66		219.9	0.56		14.2	6.87		174.4	1.96		49.7
AEP422040BV	8.66		219.9	0.56		14.2	6.87		174.4	1.96		49.7

* **E** logo indicates where ERGO-DRIVE sockets/extensions benefit tool operation.

ACRADYNE® PISTOL GRIP NUTRUNNERS



AEP35075AV



AEP35635A

APPLICATION DATA

5000 SERIES	NM	MAX TORQUE	FT-LB	NM	TORQUE RANGE	FT-LB	FREE SPEED RPM	LB	WEIGHT (-) SOCKET	KG	OUTPUT DRIVE
AEP35075AV(T)	75		55	19 - 75		14 - 55	944	9.2		4.17	1/2 SQ. DR.
AEP35090AV(T)	90		66	23 - 90		17 - 66	767	9.2		4.17	1/2 SQ. DR.
AEP35110AV(T)	110		81	28 - 110		21 - 81	634	9.2		4.17	1/2 SQ. DR.
AEP35135AV(T)	135		99	34 - 135		25 - 99	515	9.2		4.17	1/2 SQ. DR.
AEP35170AV(T)	170		125	43 - 170		32 - 125	418	9.2		4.17	1/2 SQ. DR.
AEP35280A(T)	280		206	70 - 280		52 - 207	236	13.6		6.17	3/4 SQ. DR.
AEP35350A(T)	350		258	88 - 350		65 - 258	192	13.6		6.17	3/4 SQ. DR.
AEP35420A(T)	420		310	105 - 420		78 - 310	159	13.6		6.17	3/4 SQ. DR.
AEP35515A(T)	515		380	128 - 515		95 - 380	129	13.6		6.17	3/4 SQ. DR.
AEP35635A(T)	635		468	159 - 635		117 - 469	104	13.6		6.17	3/4 SQ. DR.

"V" indicates extended Ergo-Drive output. 

Add "T" to part numbers for top exit cable models.

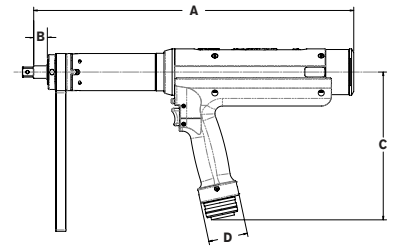

DIMENSIONS

5000 SERIES	IN	(A)	MM	IN	(B)	MM	IN	(C)	MM	IN	(D)	MM
AEP35075AV	15.95		405.2	.68		17.4	7.37		187.1	1.96		49.7
AEP35090AV	15.95		405.2	.68		17.4	7.37		187.1	1.96		49.7
AEP35110AV	15.95		405.2	.68		17.4	7.37		187.1	1.96		49.7
AEP35135AV	15.95		405.2	.68		17.4	7.37		187.1	1.96		49.7
AEP35170AV	15.95		405.2	.68		17.4	7.37		187.1	1.96		49.7
AEP35280A	18.43		468.2	1.11		28.1	7.37		187.1	1.96		49.7
AEP35350A	18.43		468.2	1.11		28.1	7.37		187.1	1.96		49.7
AEP35420A	18.43		468.2	1.11		28.1	7.37		187.1	1.96		49.7
AEP35515A	18.43		468.2	1.11		28.1	7.37		187.1	1.96		49.7
AEP35635A	18.43		468.2	1.11		28.1	7.37		187.1	1.96		49.7

*  logo indicates where ERGO-DRIVE sockets/extensions benefit tool operation.

ACRADYNE® ANGLE NUTRUNNERS

FEATURES AND BENEFITS

AcraDyne® angle nutrunners provide are the perfect solution to space-limited fastening applications that are not practical with inline or pistol model tools. A compact, durable head houses a precision right angle gear set which fits into the tightest of spaces and delivers a highly accurate fastening cycle. Lightweight materials and a uniform body diameter provide a comfortable grip and an ergonomically placed start lever allows for simple control.



APPLICATION DATA

2000 SERIES*	MAX TORQUE		NM	TORQUE RANGE		FREE SPEED RPM	WEIGHT (-)		OUTPUT DRIVE
	NM	FT-LB		FT-LB	LB		SOCKET	KG	
AEN32015C(F)(DL)	15	11	3 - 15	2.2 - 11	1,481	2.7	1.22	3/8 SQ. DR.	
AEN32025C(F)(DL)	25	18	5 - 20	3.7 - 15	833	2.7	1.22	3/8 SQ. DR.	
AEN32030C(F)(DL)	30	22	6 - 30	4.4 - 22	803	2.8	1.27	3/8 SQ. DR.	
AEN32040C(F)(DL)	40	30	8 - 40	5.9 - 29	574	2.8	1.27	3/8 SQ. DR.	

3000 SERIES*	MAX TORQUE		NM	TORQUE RANGE		FREE SPEED RPM	WEIGHT (-)		OUTPUT DRIVE
	NM	FT-LB		FT-LB	LB		SOCKET	KG	
AEN33042C(F)	42	31	9.5 - 42	7 - 31	1,095	4.4	2.00	3/8 SQ. DR.	
AEN33053C(F)	53	39	12 - 53	8 - 39	865	4.4	2.00	3/8 SQ. DR.	
AEN33060C(F)(DL)	60	44	12 - 60	9 - 44	845	6.6	2.99	1/2 SQ. DR.	
AEN33090C(F)(DL)	90	66	18 - 90	13 - 66	568	6.6	2.99	1/2 SQ. DR.	
AEN33120C(F)(DL)	120	89	24 - 120	18 - 88	442	9.3	4.22	1/2 SQ. DR.	
AEN33200C(F)(DL)	200	148	40 - 200	29 - 147	245	9.4	4.26	3/4 SQ. DR.	
AEN33210C(F)(DL)	210	95	50 - 210	37 - 155	234	10.0	4.54	3/4 SQ. DR.	
AEN33300C(F)(DL)	300	221	60 - 300	42 - 221	151	10.0	4.54	3/4 SQ. DR.	
AEN33375C(F)(DL)	375	277	75 - 375	55 - 276	151	10.0	4.54	3/4 SQ. DR.	

* Add "F" to part numbers for flush socket.

Add "DL" to part numbers for dual levers.

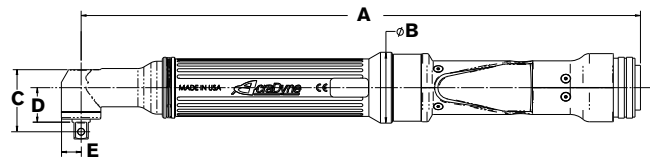

DIMENSIONS

2000 SERIES	IN	(A)	MM	IN	(B)	MM	IN	(C)	MM	IN	(D)	MM	IN	(E)	MM
	AEN32015C	14.61		371	1.85		47	1.37		34.8	.90		22.9	.52	
AEN32025C	14.61		371	1.85		47	1.37		34.8	.90		22.9	.52		13.1
AEN32030C	14.42		366.2	1.85		47	1.65		41.8	1.16		29.4	.70		17.8
AEN32040C	14.42		366.2	1.85		47	1.65		41.8	1.16		29.4	.70		17.8

3000 SERIES	IN	(A)	MM	IN	(B)	MM	IN	(C)	MM	IN	(D)	MM	IN	(E)	MM
	AEN33042C	16.63		422.33	1.85		47	1.66		42.11	1.17		29.67	.7	
AEN33053C	16.63		422.33	1.85		47	1.66		42.11	1.17		29.67	.7		17.78
AEN33060C	18.92		480.53	1.85		47	1.90		48.36	1.37		34.90	.83		20.96
AEN33090C	18.92		480.53	1.85		47	1.90		48.36	1.37		34.90	.83		20.96
AEN33120C	21.00		533.46	1.85		47	2.78		70.59	2.08		52.81	1.05		26.67
AEN33200C	23.21		589.64	1.85		47	2.59		65.75	1.89		47.98	1.05		26.67
AEN33210C	23.58		598.88	1.85		47	2.90		73.53	1.97		50.04	1.25		31.75
AEN33300C	23.58		598.88	1.85		47	2.90		73.53	1.97		50.04	1.25		31.75
AEN33375C	23.58		598.88	1.85		47	2.90		73.53	1.97		50.04	1.25		31.75

ACRADYNE® ANGLE NUTRUNNERS



APPLICATION DATA

5000 SERIES*	NM	MAX TORQUE FT-LB	NM	TORQUE RANGE FT-LB	FREE SPEED RPM	LB	WEIGHT (-) SOCKET	KG	OUTPUT DRIVE
AEN35090B(F)	90	66	23 - 90	17 - 66	607	6.9	3.13	1/2 SQ. DR.	
AEN35140B(F)	140	103	35 - 140	26 - 103	472	10.4	4.72	3/4 SQ. DR.	
AEN35175B(F)	175	129	44 - 175	33 - 129	384	10.5	4.76	3/4 SQ. DR.	
AEN35225B(F)	225	166	56 - 225	41 - 166	291	12.3	5.58	3/4 SQ. DR.	
AEN35285B(F)	285	210	71 - 285	52 - 210	236	12.3	5.58	3/4 SQ. DR.	
AEN35350B(F)	350	258	88 - 350	65 - 258	191	12.3	5.58	3/4 SQ. DR.	

* Add "F" to part numbers for flush socket.

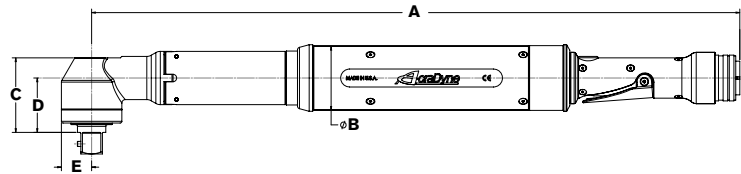

DIMENSIONS

5000 SERIES	IN	(A)	MM	IN	(B)	MM	IN	(C)	MM	IN	(D)	MM	IN	(E)	MM
AEN35090B	22.59		573.7	2.31		58.7	1.90		48.4	1.37		34.9	.81		20.6
AEN35140B	22.52		571.9	2.31		58.7	2.59		65.8	1.89		48	1.05		26.7
AEN35175B	22.52		571.9	2.31		58.7	2.59		65.8	1.89		48	1.05		26.7
AEN35225B	22.88		581.1	2.31		58.7	2.90		73.5	1.97		50	1.25		31.8
AEN35285B	22.88		581.1	2.31		58.7	2.90		73.5	1.97		50	1.25		31.8
AEN35350B	22.88		581.1	2.31		58.7	2.90		73.5	1.97		50	1.25		31.8

ACRADYNE® IN-LINE NUTRUNNERS

FEATURES AND BENEFITS

AcraDyne® inline nutrunners are the perfect choice for fixtured fastening applications because of their compact size and durability. A uniform body diameter and a hex shaped mounting point allow for simple installation into fixture plates. Simply machine a female hex into a steel plate, insert the nutrunner, secure with the factory supplied nut and your fastening machine is assembled. A reaction bar for use in handheld applications is also included with all AcraDyne® inline nutrunners.



APPLICATION DATA

2000 SERIES*	NM	MAX TORQUE	FT-LB	NM	TORQUE RANGE	FT-LB	FREE SPEED RPM	LB	WEIGHT (-) SOCKET	KG	OUTPUT DRIVE
AES32010C(V)(Q)	10		74	2 - 10		1.5 - 74	2,222	2.5		1.13	3/8 SQ. DR.*
AES32020C(V)(Q)	20		15	4 - 20		3.0 - 15	1,250	2.5		1.13	3/8 SQ. DR.*
AES32025C(V)(Q)	25		18	5 - 25		3.7 - 18	893	3.2		1.45	3/8 SQ. DR.*
AES32038C(V)	38		28	7.5 - 38		5.5 - 28	595	4.2		1.91	3/8 SQ. DR.

3000 SERIES*	NM	MAX TORQUE	FT-LB	NM	TORQUE RANGE	FT-LB	FREE SPEED RPM	LB	WEIGHT (-) SOCKET	KG	OUTPUT DRIVE
AES33040C(V)(-2)	40		30	8 - 40		5.9 - 30	1,314	6.4		2.90	1/2 SQ. DR.
AES33060C(V)(-2)	60		44	12 - 60		8.9 - 44	883	6.4		2.90	1/2 SQ. DR.
AES33100C(V)(-2)	100		74	20 - 100		15 - 74	489	8.1		3.67	1/2 SQ. DR.
AES33150C(V)(-2)	150		111	30 - 150		22 - 111	329	8.1		3.67	1/2 SQ. DR.
AES33230C(V)(-2)	230		170	46 - 184		34 - 184	221	8.1		3.67	1/2 SQ. DR.
AES33400C	400		295	80 - 400		59 - 295	122	13.0**		5.90**	3/4 SQ. DR.
AES33600C	600		440	120 - 480		89 - 440	82	13.0**		5.90**	3/4 SQ. DR.

* Add "Q" to part numbers for 1/4" quick change output standard. Add "V" to part numbers for standard spindle models. Add "-2" to part numbers for 2" sliding spindle models, and add 2.3 lb to the weight listed.

**Includes reaction bar and fixture nut

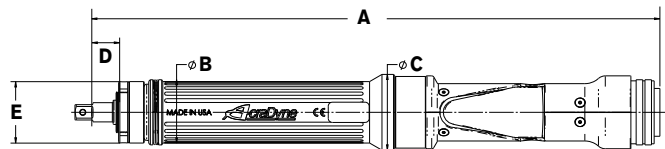

DIMENSIONS

2000 SERIES	IN	(A)	MM	IN	(B)	MM	IN	(C)	MM	IN	(D)	MM	IN	(E)	MM
AES32010CV	13.85		351.7	1.59		40.4	1.85		47	.56		14.3	1.50		38.1
AES32020CV	13.85		351.7	1.59		40.4	1.85		47	.56		14.3	1.50		38.1
AES32025CV	13.85		351.7	1.59		40.4	1.85		47	.56		14.3	1.50		38.1
AES32038CV	16.69		424	1.50		38.1	1.85		47	.51		12.9	1.50		38.1

3000 SERIES	IN	(A)	MM	IN	(B)	MM	IN	(C)	MM	IN	(D)	MM	IN	(E)	MM
AES33040CV	18.24		463.38	1.94		49.28	1.85		47	.68		17.17	1.85		47
AES33060CV	18.24		463.38	1.94		49.28	1.85		47	.68		17.17	1.85		47
AES33100CV	22.56		572.99	1.94		49.28	1.85		47	.68		17.17	1.85		47
AES33150CV	22.56		572.99	1.94		49.28	1.85		47	.68		17.17	1.85		47
AES33230CV	22.56		572.99	1.94		49.28	1.85		47	.68		17.17	1.85		47
AES33400C	24.90		532.36	1.94		49.28	1.85		47	1.11		28.08	2.64		67.1
AES33600C	24.90		532.36	1.94		49.28	1.85		47	1.11		28.08	2.64		67.1

* E logo indicates where ERGO-DRIVE sockets/extensions benefit tool operation.

ACRADYNE® IN-LINE NUTRUNNERS



AES35170-AV



AES35280A

APPLICATION DATA

5000 SERIES	NM	MAX TORQUE	FT-LB	NM	TORQUE RANGE	FT-LB	FREE SPEED RPM	LB	WEIGHT (-) SOCKET	KG	OUTPUT DRIVE
AES35075AV	75		55	19 - 75		14 - 55	944	9.2		4.17	1/2 SQ. DR.
AES35090AV	90		66	23 - 90		17 - 66	767	9.2		4.17	1/2 SQ. DR.
AES35110AV	110		81	28 - 110		21 - 81	634	9.2		4.17	1/2 SQ. DR.
AES35135AV	135		100	34 - 135		25 - 100	515	9.2		4.17	1/2 SQ. DR.
AES35170AV	170		126	43 - 170		32 - 126	418	9.2		4.17	1/2 SQ. DR.
AES35280A	280		207	70 - 280		52 - 207	236	12.8		5.81	3/4 SQ. DR.
AES35350A	350		258	88 - 350		65 - 258	192	12.8		5.81	3/4 SQ. DR.
AES35420A	420		310	105 - 420		78 - 310	159	12.8		5.81	3/4 SQ. DR.
AES35515A	515		380	128 - 515		95 - 380	129	12.8		5.81	3/4 SQ. DR.
AES35635A	635		469	159 - 635		117 - 469	104	12.8		5.81	3/4 SQ. DR.

"V" indicates extended Ergo-Drive output.

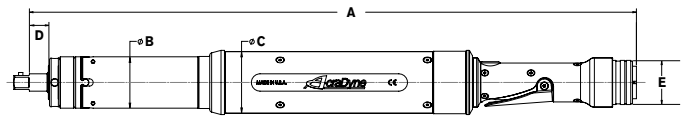

DIMENSIONS

5000 SERIES	IN	(A)	MM	IN	(B)	MM	IN	(C)	MM	IN	(D)	MM	IN	(E)	MM
AES35075AV	21.86		555.2	1.85	47	2.31	58.7	.68	17.4	1.78	45.2				
AES35090AV	21.86		555.2	1.85	47	2.31	58.7	.68	17.4	1.78	45.2				
AES35110AV	21.86		555.2	1.85	47	2.31	58.7	.68	17.4	1.78	45.2				
AES35135AV	21.86		555.2	1.85	47	2.31	58.7	.68	17.4	1.78	45.2				
AES35170AV	21.86		555.2	1.85	47	2.31	58.7	.68	17.4	1.78	45.2				
AES35280A	24.22		615.1	2.64	67.1	2.31	58.7	1.11	28.1	1.78	45.2				
AES35350A	24.22		615.1	2.64	67.1	2.31	58.7	1.11	28.1	1.78	45.2				
AES35420A	24.22		615.1	2.64	67.1	2.31	58.7	1.11	28.1	1.78	45.2				
AES35515A	24.22		615.1	2.64	67.1	2.31	58.7	1.11	28.1	1.78	45.2				
AES35635A	24.22		615.1	2.64	67.1	2.31	58.7	1.11	28.1	1.78	45.2				

* logo indicates where ERGO-DRIVE sockets/extensions benefit tool operation.

ACRADYNE® FIXTURED NUTRUNNERS



AEF35135AV
Standard Spindle, Rear Exit Cable



AEF35135AVB
Standard Spindle, Bottom Exit Cable



AEF35350A
Standard Spindle, Rear Exit Cable



AEF35135A-2
2" Sliding Spindle, Rear Exit Cable



AEF35135AB-2
2" Sliding Spindle, Rear Exit Cable

APPLICATION DATA

5000 SERIES*	NM	MAX TORQUE FT-LB	NM	TORQUE RANGE FT-LB	FREE SPEED RPM	LB	WEIGHT (-) SOCKET KG	OUTPUT DRIVE
AEF35075A(V)(VB)(-2)(B-2)	75	55	19 - 75	14 - 55	944	9.6	4.35	1/2 SQ. DR.
AEF35090A(V)(VB)(-2)(B-2)	90	66	23 - 90	17 - 66	767	9.6	4.35	1/2 SQ. DR.
AEF35110A(V)(VB)(-2)(B-2)	110	81	28 - 110	21 - 81	634	9.6	4.35	1/2 SQ. DR.
AEF35135A(V)(VB)(-2)(B-2)	135	100	34 - 135	25 - 100	515	9.6	4.35	1/2 SQ. DR.
AEF35170A(V)(VB)(-2)(B-2)	170	125	43 - 170	32 - 125	418	9.6	4.35	1/2 SQ. DR.
AEF35280A(V)(VB)(-2)(B-2)	280	207	70 - 280	52 - 207	236	13.6	6.17	3/4 SQ. DR.
AEF35350A(V)(VB)(-2)(B-2)	350	258	88 - 350	65 - 258	192	13.6	6.17	3/4 SQ. DR.
AEF35420A(V)(VB)(-2)(B-2)	420	310	105 - 420	77 - 310	159	13.6	6.17	3/4 SQ. DR.
AEF35515A(V)(VB)(-2)(B-2)	515	380	128 - 515	95 - 380	129	13.6	6.17	3/4 SQ. DR.
AEF35635A(V)(VB)(-2)(B-2)	635	469	159 - 635	117 - 469	104	13.6	6.17	3/4 SQ. DR.

* Add "V" to part numbers for standard spindle with rear exit cable models. Add "VB" to part numbers for standard spindle with bottom exit cable models.

* Add "-2" to part numbers for 2" sliding spindle with rear exit cable models. Add "B-2" to part numbers for 2" sliding spindle with bottom exit cable models.

* Item 28843 is a panel mount 2" sliding spindle for 280 - 635 Nm models.

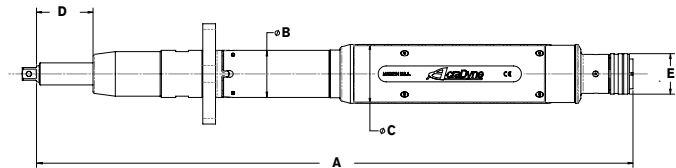

DIMENSIONS

5000 SERIES	IN	(A)	MM	IN	(B)	MM	IN	(C)	MM	IN	(D)	MM	IN	(E)	MM
AEF35075AV	17.67		448.8	1.85		47	2.31		58.7	.72		18.4		1.59	40.4
AEF35090AV	17.67		448.8	1.85		47	2.31		58.7	.72		18.4		1.59	40.4
AEF35110AV	17.67		448.8	1.85		47	2.31		58.7	.72		18.4		1.59	40.4
AEF35135AV	17.67		448.8	1.85		47	2.31		58.7	.72		18.4		1.59	40.4
AEF35170AV	17.67		448.8	1.85		47	2.31		58.7	.72		18.4		1.59	40.4
AEF35075A-2	23.43		595.1	1.85		47	2.31		58.7	2.22		56.4		1.59	40.4
AEF35090A-2	23.43		595.1	1.85		47	2.31		58.7	2.22		56.4		1.59	40.4
AEF35110A-2	23.43		595.1	1.85		47	2.31		58.7	2.22		56.4		1.59	40.4
AEF35135A-2	23.43		595.1	1.85		47	2.31		58.7	2.22		56.4		1.59	40.4
AEF35170A-2	23.43		595.1	1.85		47	2.31		58.7	2.22		56.4		1.59	40.4
AEF35280A	18.43		468.2	1.11		28.1	7.37		187.1	1.96		49.7		20.4	518
AEF35350A	18.43		468.2	1.11		28.1	7.37		187.1	1.96		49.7		20.4	518
AEF35420A	18.43		468.2	1.11		28.1	7.37		187.1	1.96		49.7		20.4	518
AEF35515A	18.43		468.2	1.11		28.1	7.37		187.1	1.96		49.7		20.4	518
AEF35635A	18.43		468.2	1.11		28.1	7.37		187.1	1.96		49.7		20.4	518

* logo indicates where ERGO-DRIVE sockets/extensions benefit tool operation.

ACRADYNE[®] TUBENUT NUTRUNNERS AND SPECIALTY GEARHEADS

FEATURES AND BENEFITS

- Patented Safety Algorithm.
- Transducer senses resistance in the initial 90 degrees of rotation and returns to open upon any resistance encountered.
- Durable tubenut head design.
- Simple, one-touch back to open operation for maximum productivity.



AET 2000 Series Model

AET 1000 Series Model

WITH INNOVATIVE SAFETY SENSOR TECHNOLOGY!

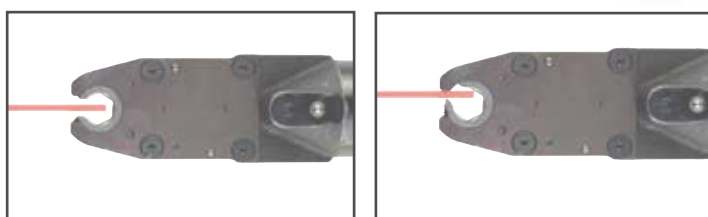

AET 2000 Series Model with Double Levers

APPLICATION DATA

1000 SERIES*	MAX TORQUE		TORQUE RANGE		FREE SPEED	WEIGHT (-) SOCKET	IN	OUTPUT DRIVE
	NM	FT-LB	NM	FT-LB	RPM			
AET4AA12018B	14	13	3.6 - 14	2.7 - 11	516	3.1	1/4 - 7/16	7 - 12
AET4AB12025B	20	18	5 - 20	3.7 - 15	387	3.1	3/8 - 5/8	10 - 17
AET4A12025B-KD	20	18	5 - 20	3.7 - 15	387	3.1	3/8 - 5/8	10 - 17

2000 SERIES*	MAX TORQUE		TORQUE RANGE		FREE SPEED	WEIGHT (-) SOCKET	IN	OUTPUT DRIVE
	NM	FT-LB	NM	FT-LB	RPM			
AET32020C(DL)	20	15	4 - 16	3.0 - 12	622	3.1	1/4 - 7/16	7 - 12
AET32025C(DL)	25	18	5 - 20	3.7 - 15	466	4.0	3/8 - 5/8	10 - 17
AET32035C(DL)	35	26	7 - 28	5.2 - 21	347	4.5	1/2 - 7/8	13 - 24
AET32050C(DL)	50	37	10 - 40	7.4 - 30	257	5.6	5/8 - 1-3/16	17 - 32

* Add "DL" to part numbers for double levers. Request specific socket size when placing your order. AIMCO offers a wide variety of socket sizes to fit your needs. Contact AIMCO at 1-800-852-1368.

SPECIALTY GEARHEADS

AIMCO can provide specialized heads for almost any application. Tubenut, Hold and Drive, Crow Foot, Offsets and Sliding Spindles are just a few of the head styles available. Whatever your requirements are, we will help select the head configuration to get the job done.



ACRADYNE® HOLD & DRIVE NUTRUNNERS

FEATURES AND BENEFITS

- Torques Ranging from 20 Nm – 200 Nm.
- Very Robust modern design.
- 1" and 2" travels are standard.
- Sockets and holders are custom to order.

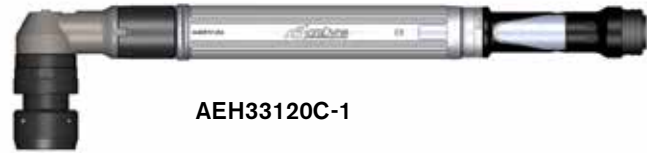

AEH33120C-1



AEH32040C-1

APPLICATION DATA

MODEL*	NM	MAX TORQUE	FT-LB	NM	TORQUE RANGE	FT-LB	FREE SPEED RPM	WEIGHT LB		MIN/MAX SOCKET
AEH4F12020B-(1,2)	20		15	4 - 20		3 - 15	533	-1=2.8,	-2=3.0	9/16 (14 MM) / 13/16, (21 MM)
AEH4F12026B-(1,2)	26		19	5 - 26		4 - 19	432	-1=2.8,	-2=3.1	9/16 (14 MM) / 13/16, (21 MM)
AEH32025C-(1,2)	25		18	5 - 25		4 - 18	833	-1 = 3.5,	-2=3.5	9/16 (14 MM) / 13/16, (21 MM)
AEH32030C-(1,2)	30		22	6 - 30		4 - 22	803	-1 = 3.5,	-2=3.6	9/16 (14 MM) / 13/16, (21 MM)
AEH32040C-(1,2)	40		30	8 - 40		6 - 30	574	-1 = 3.5,	-2=3.7	9/16 (14 MM) / 13/16, (21 MM)
AEH33042C-(1,2)	42		31	10 - 42		7 - 31	1,095	-1=5.6,	-2=5.8	9/16 (14 MM) / 13/16, (21 MM)
AEH33053C-(1,2)	53		39.	12 - 53		8 - 39	865	-1=5.6,	-2=5.8	9/16 (14 MM) / 13/16, (21 MM)
AEH33060C-(1,2)	60		44	12 - 60		9 - 44	845	-1=7.3,	-2=7.5	5/8 (16 MM) / 1-1/4, (32 MM)
AEH33090C-(1,2)	90		66	18 - 90		13 - 66	568	-1=7.3,	-2=7.6	5/8 (16 MM) / 1-1/4, (32 MM)
AEH33120C-(1,2)	120		89	24 - 120		18 - 89	442	-1=10.0,	-2=10.3	5/8 (16 MM) / 1-1/4, (32 MM)
AEH33200C-(1,2)	200		148	40 - 200		29 - 148	245	-1=10.0,	-2=10.4	5/8 (16 MM) / 1-1/4, (32 MM)
AEH35140B-(1,2)	140		103	35 - 140		26 - 103	472	-1=10.6,	-2=11.0	5/8 (16 MM) / 1-1/4, (32 MM)
AEH35175B-(1,2)	175		129	44 - 175		33 - 129	384	-1=10.6,	-2=11.1	5/8 (16 MM) / 1-1/4, (32 MM)

* Add "1" to part numbers for 1" travel. Add "2" to part numbers for 2" travel.

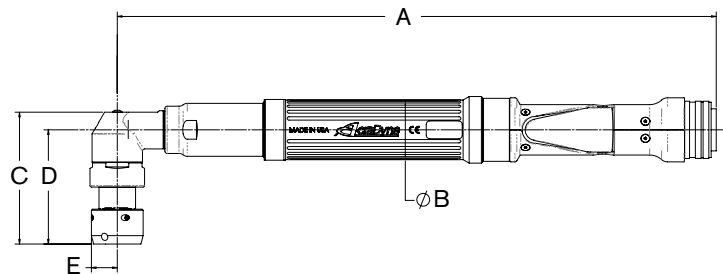

DIMENSIONS

MODEL	IN	(A)	MM	IN	(B)	MM	IN	(C)	MM	IN	(D)*	MM	IN	(E)	MM
AEH4F12020B-1	14.59		370.7	1.59		40.4	3.72		94.4	3.17		80.6	.76		19.3
AEH4F12026B-1	14.59		370.7	1.59		40.4	3.72		94.4	3.17		80.6	.76		9.3
AEH32025C-1	14.59		370.7	1.85		47	3.72		94.4	3.17		80.6	.76		19.3
AEH32030C-1	14.59		370.7	1.85		47	3.72		94.4	3.17		80.6	.76		19.3
AEH32040C-1	14.59		370.7	1.85		47	3.72		94.4	3.17		80.6	.76		19.3
AEH33053C-1	16.79		426.5	1.85		47	3.72		94.4	3.17		80.6	.76		19.3
AEH33060C-1	18.92		480.53	1.96		49.8	4.04		102.5	3.37		85.66	.94		23.9
AEH33090C-1	18.92		480.53	1.96		49.8	4.04		102.5	3.37		85.66	.94		23.9
AEH33120C-1	21.00		533.49	1.96		49.8	4.87		123.66	4.09		103.82	1.13		28.6
AEH33200C-1	23.21		589.5	1.96		49.8	4.87		123.66	4.09		103.82	1.13		28.6
AEH35140C-1	22.52		572.0	2.31		58.7	4.87		123.66	4.09		103.82	1.13		28.6
AEH35170C-1	22.52		572.0	2.31		58.7	4.87		123.66	4.09		103.82	1.13		28.6

ACRADYNE® MID-EXIT CABLE NUTRUNNERS

FEATURES AND BENEFITS

- Length
 - The tool's length is reduced by the cable exiting in front of the grip surface.
- Ergonomics
 - Torque reaction is reduced relative to pistol style tools.
 - The hand is positioned farther away from the application for more leverage. This is maximized by the cable being in front of the hand. The handle is inline, putting less stress on the wrist.
- Cable management
 - If used with a spring balancer, the tool hangs naturally near its center of gravity, the cable is controlled by the balancer.
 - The front position of the cable provides easy cable management. This is especially beneficial where one plane has length constraints and at 90° is free from obstruction (vertical for Doors-On).

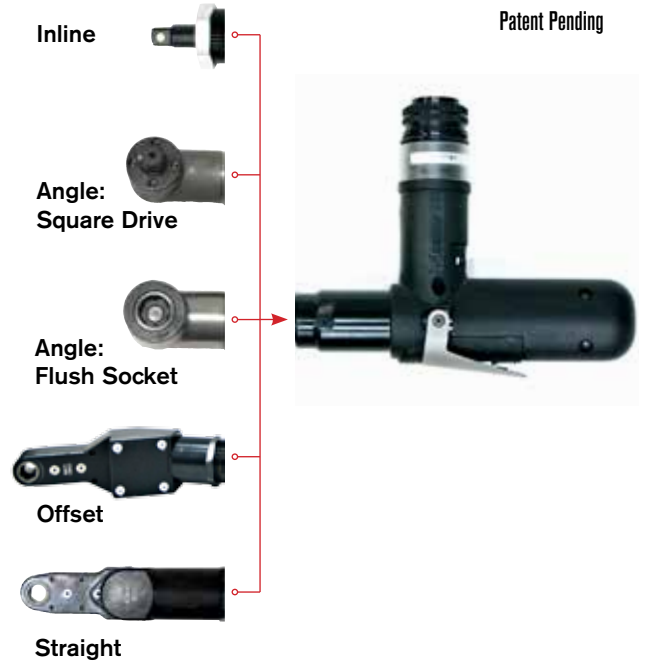

Specialized heads and blades available by request. Contact AIMCO at 1-800-852-1368.

APPLICATION DATA

MODEL*	NM	MAX TORQUE FT-LB	NM	TORQUE RANGE FT-LB	FREE SPEED RPM	LB	WEIGHT (-) SOCKET	KG	OUTPUT DRIVE
AEN4C22015BM(F)	15	11	3.75 - 15	2.77 - 11	700	2.6	1.18	3/8 sq. dr.	
AEN4F22030BM(F)	30	22	7.5 - 30	5.53 - 22	675	3.3	1.50	3/8 sq. dr.	
AEN4F22037BM(F)	37	29	9.25 - 37	6.82 - 29	533	3.3	1.50	3/8 sq. dr.	
AEN4F22044BM(F)	44	32	11 - 40	8.11 - 29	432	3.3	1.50	3/8 sq. dr.	
AES4A22020BVM	20	15	5 - 20	3.7 - 15	1050	2.4	1.09	3/8 sq. dr.	
AES4A22025BVM	25	18	6.3 - 25	4.6 - 18	830	2.4	1.09	3/8 sq. dr.	
AES4A22030BVM	30	22	7.5 - 30	5.5 - 22	672	2.4	1.09	3/8 sq. dr.	
AES4A22040BVM	40	30	10 - 40	7.4 - 30	525	2.4	1.09	3/8 sq. dr.	

* Add "F" to part numbers for flush socket.

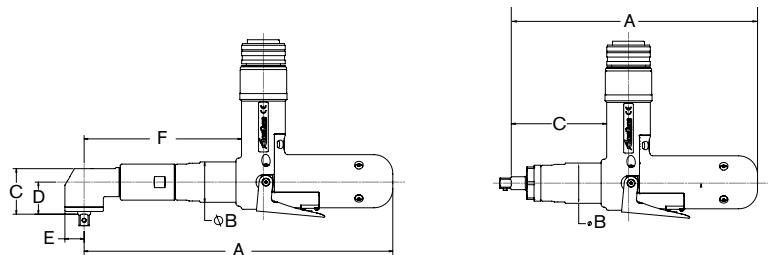

DIMENSIONS

MODEL	IN	(A)	MM	IN	(B)	MM	IN	(C)	MM	IN	(D)	MM	IN	(E)	MM	IN	(F)	MM
AEN4C22015BM	9.02		229.1	1.47		37.3	1.29		32.8	.82		20.9	.52		13.1	5.53		140.4
AEN4D22023BM	11.1		280.3	1.47		37.3	1.42		36.1	.92		23.4	.56		14.1	5.67		144.1
AEN4D22029BM	11.1		280.3	1.47		37.3	1.42		36.1	.92		23.4	.56		14.1	5.67		144.1
AEN4D22035BM	11.1		280.3	1.47		37.3	1.42		36.1	.92		23.4	.56		14.1	5.67		144.1
AEN4F22030BM	11.24		285.6	1.47		37.3	1.66		42.1	1.17		29.7	.70		17.8	5.73		145.6
AEN4F22037BM	11.24		285.6	1.47		37.3	1.66		42.1	1.17		29.7	.70		17.8	5.73		145.6
AEN4F22044BM	11.24		285.6	1.47		37.3	1.66		42.1	1.17		29.7	.70		17.8	5.73		145.6
AES4A22020BM	9.0		228.1	1.47		37.3	3.49		88.6									
AES4A22025BM	9.0		228.1	1.47		37.3	3.49		88.6									
AES4A22030BM	9.0		228.1	1.47		37.3	3.49		88.6									
AES4A22040BM	9.0		228.1	1.47		37.3	3.49		88.6									

ACRADYNE® RIV-NUT NUTRUNNERS

FEATURES AND BENEFITS

- Top and Rear exit cable are standard.
- Straight, Fixtured and Push to Start models are available by request. Contact AIMCO at 1-800-852-1368.



Top Exit Cable



Rear Exit Cable



Bottom Exit Cable

APPLICATION DATA

MODEL*	NM	MAX TORQUE	FT-LB	NM	TORQUE RANGE	FT-LB	FREE SPEED RPM	LB	WEIGHT (-) SOCKET	KG	OUTPUT DRIVE
AEP4(A,R,T)12011BR	11		8.1	2.8 - 11		2 - 8.1	1,313	2.3		1.04	3/8 sq. dr.
AEP4(A,R,T)12014BR	14		10	3.5 - 14		2.6 - 10	1,037	2.3		1.04	3/8 sq. dr.
AEP4(A,R,T)12018BR	18		13	4.5 - 18		3.3 - 13	840	2.3		1.04	3/8 sq. dr.
AEP4(A,R,T)12022BR	22		16	5.5 - 22		4.1 - 16	656	2.3		1.04	3/8 sq. dr.
AEP4(A,R,T)22020BR	20		15	5 - 20		3.7 - 15	1,313	2.4		1.09	3/8 sq. dr.
AEP4(A,R,T)22025BR	25		18	6.3 - 25		4.6 - 18	1,037	2.4		1.09	3/8 sq. dr.
AEP4(A,R,T)22030BR	30		22	7.5 - 30		5.5 - 22	840	2.4		1.09	3/8 sq. dr.
AEP4(A,R,T)22040BR	40		30	10 - 40		7.4 - 30	656	2.4		1.09	3/8 sq. dr.

* Add "A" to part numbers for bottom exit cable models, Add "R" to part numbers for rear exit cable models, Add "T" to part numbers for top exit cable models,

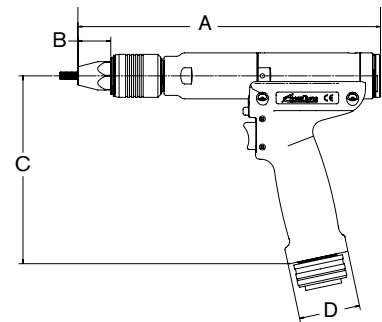

DIMENSIONS

MODEL	IN	(A)	MM	IN	(B)	MM	IN	(C)	MM	IN	(D)*	MM
AEP412011BR	9.68		245.9	1.05		26.7	6.87		174.5	1.96		49.8
AEP412014BR	9.68		245.9	1.05		26.7	6.87		174.5	1.96		49.8
AEP412018BR	9.68		245.9	1.05		26.7	6.87		174.5	1.96		49.8
AEP412022BR	9.68		245.9	1.05		26.7	6.87		174.5	1.96		49.8
AEP422020BR	10.18		258.6	1.05		26.7	6.87		174.5	1.96		49.8
AEP422025BR	10.18		258.6	1.05		26.7	6.87		174.5	1.96		49.8
AEP422030BR	10.18		258.6	1.05		26.7	6.87		174.5	1.96		49.8
AEP422040BR	10.18		258.6	1.05		26.7	6.87		174.5	1.96		49.8

ACRADYNE® HIGH TORQUE D/C TOOLS

Critical bolting demands tools that will deliver high torque with superior performance. The HT Series from AcraDyne combines these features in an electric high-torque bolting tool that beats the competition in accuracy, speed, and safety.

When combined with AcraDyne's controller, customers have a high-torque critical bolting system that can handle the toughest and most important bolting jobs.

FEATURES AND BENEFITS

- One of the most accurate high-torque tools in the world today
- Up to 100 times faster than hydraulic tools
- 1 Nm - 8,100 Nm
- Ergonomic, robust design with five handle configurations
- Over 300 models to choose from
- Built-in integral transducer for optimal monitoring and control
- The world's ONLY traceable system at the square drive for high-torque bolting
- Data retrieval
- Designed and **MADE IN THE USA**



Pistol Type (AEP)



Rear Mounted Pistol (AED)



Axial Type (AEJ)



Fixtured Type (AEF)



Straight Lever Type (AES)

FIXED GEARCASE MODEL*	SERIES	APPROX. TORQUE		APPROX. SPEED rpm	WEIGHT		LENGTH		DIA.		DRIVE in	SOUND LEVEL dBA
		Nm	ft-lb		kg	lb	mm	in	mm	in		
(AEP) (AED) (AES) (AEJ) (AEF)4A66250B	6000	250	185	315	4.6	10.5	254	10	66	2.6	0.75	66
(AEP) (AED) (AES) (AEJ) (AEF)4A66425B	6000	425	315	165	4.6	10.5	254	10	66	2.6	0.75	66
(AEP) (AED) (AES) (AEJ) (AEF)4A66625B	6000	625	460	106	4.8	10.5	254	10	66	2.6	0.75	66
(AEP) (AED) (AES) (AEJ) (AEF)4A66925B	6000	925	682	72	4.8	10.5	254	10	66	2.6	0.75	66
(AEP) (AED) (AES) (AEJ) (AEF)4A771200B	7000	1200	885	65	6.6	14.5	259	10.2	76	3.0	1	66
(AEP) (AED) (AES) (AEJ) (AEF)4A773000B	7000	3,000	2,213	25	7.5	16.5	294	11.6	76	3.0	1	66
(AEP) (AED) (AES) (AEJ) (AEF)4A884200B1	8000	4,200	3,100	12	11.1	24.5	340	13.4	86	3.6	1	66
(AEP) (AED) (AES) (AEJ) (AEF)4A884200B	8000	4,200	3,100	12	11.1	24.5	340	13.4	86	3.6	1.5	66
(AEP) (AED) (AES) (AEJ) (AEF)4A885000B	8000	5,000	3,700	9	11.1	24.5	340	13.4	86	3.6	1.5	66
(AEP) (AED) (AES) (AEJ) (AEF)4A896500B	8000/9000	6,500	4,800	7	15.7	34.5	378	14.9	101	4.0	1.5	66
(AEP) (AED) (AES) (AEJ) (AEF)4A898100B	8000/9000	8,100	6,000	5	15.7	34.5	378	14.9	101	4.0	1.5	66

* Add "B" to the end of the model number for bottom exit cable (AEF fixtured models only).

CLUTCHED MODEL	SERIES	APPROX. TORQUE		APPROX. SPEED rpm	WEIGHT		LENGTH		DIA.		DRIVE in	SOUND LEVEL dB(A)
		Nm	ft-lb		kg	lb	mm	in	mm	in		
(AEP) (AEJ)4B66250B	6000	250	185	315	5.3	12	305	12	66	2.6	0.75	66
(AEP) (AEJ)4B66425B	6000	425	315	165	5.3	12	305	12	66	2.6	0.75	66
(AEP) (AEJ)4B66625B	6000	625	460	106	5.5	12	305	12	66	2.6	0.75	66
(AEP) (AEJ)4B66925B	6000	925	682	72	5.5	12	305	12	66	2.6	0.75	66
(AEP) (AEJ)4B771200B	7000	1200	885	65	7.3	16	310	12.2	76	3.0	1	66
(AEP) (AEJ)4B773000B	7000	3,000	2,213	25	8.2	18	345	13.6	76	3.0	1	66
(AEP) (AEJ)4B884200B1	8000	4,200	3,100	12	11.8	26	391	15.4	86	3.6	1	66
(AEP) (AEJ)4B884200B	8000	4,200	3,100	12	11.8	26	391	15.4	86	3.6	1.5	66
(AEP) (AEJ)4B885000B	8000	5,000	3,700	9	11.8	26	391	15.4	86	3.6	1.5	66
(AEP) (AEJ)4B896500B	8000/9000	6,500	4,800	7	16.4	36	429	16.9	101	4.0	1.5	66
(AEP) (AEJ)4B898100B	8000/9000	8,100	6,000	5	16.4	36	429	16.9	101	4.0	1.5	66

ACRADYNE® HIGH TORQUE D/C ANGLE TOOLS

FEATURES AND BENEFITS

- Transducerized closed-loop control like all AcraDyne HT-Series tools.
- Torque is measured at the output, not before the gearing like competing products.
- A unique solution: Low profile head, small diameter, lever operated tools with the transducer at the output.
- No effect on results caused by gear wear, like other angle tools. The torque reported is the torque delivered to the fastener.
- Most accurate right-angle high torque tools in the world.
- Smallest tools of their kind on the market.
- Same durable high-cycle gearing as our other HT-series tools.
- Models up to 8,100 Nm available by special order.



AEN3571000A



AEN356540A



AEN3571600A



AEN3572600A

SPECIFICATIONS

MODEL	MAX. TORQUE*		TORQUE RANGE		FREE SPEED RPM	WEIGHT		OUTPUT DRIVE
	nm	ft.-lbs.	nm	ft.-lbs.		lbs.	kg	
AEN356540A	540	398	135-540	100-398	109	13.1	5.95	3/4" Square Drive
AEN3571000A	1000	737	250-1000	184-737	61	16.3	7.39	1" Square Drive
AEN3571600A	1600	1180	400-1600	295-1180	33	16.7	7.57	1" Square Drive
AEN3572600A	2600	1917	650-2600	479-1917	21	18.5	8.40	1" Square Drive

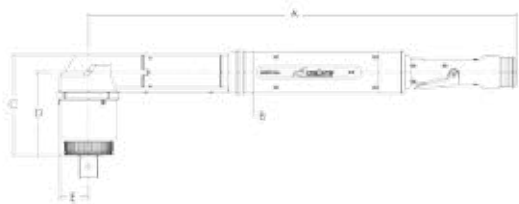

DIMENSIONS	A		B		C		D		E	
	in	mm	in	mm	in	mm	in	mm	in	mm
AEN356540A	22.58	573.6	2.31	58.7	4.75	120.6	4.05	102.8	1.33	33.7
AEN3571000A	22.92	582.2	2.31	58.7	5.36	136.1	4.44	112.7	1.53	38.7
AEN3571600A	22.92	582.2	2.31	58.7	5.36	136.1	4.44	112.7	1.53	38.7
AEN3572600A	22.92	582.2	2.31	58.7	6.77	171.9	5.86	148.8	1.53	38.7

DUAL LEVER TOOLS

FEATURES AND BENEFITS

- Additional safety when using a tool with a reaction bar or nose extension.
- Requires the operator to use both hands when starting the tool, which keeps hands clear of the application.
- Helps to avoid accidental starting of the tool.
- Available in three handle types: "Handle Bar" (F) style, Straight (S) style with side handle, and Pistol (P) style.



MODEL* (HANDLE TYPE)	SERIES	APPROX. TORQUE		APPROX. SPEED	WEIGHT		LENGTH		DIA.		DRIVE in	SOUND LEVEL dB(A)
		Nm	ft-lb	rpm	kg	lb	mm	in	mm	in		
AE(S)(F)(P)4(A)(B)66250BDL	6000	250	185	315	4.6	10.5	254	10	66	2.6	0.75	66
AE(S)(F)(P)4(A)(B)66425BDL	6000	425	315	185	4.6	10.5	254	10	66	2.6	0.75	66
AE(S)(F)(P)4(A)(B)66625BDL	6000	625	460	106	4.8	10.5	254	10	66	2.6	0.75	66
AE(S)(F)(P)4(A)(B)66925BDL	6000	925	682	72	4.8	10.5	254	10	66	2.6	0.75	66
AE(S)(F)(P)4(A)(B)771200BDL	7000	1,200	885	65	6.6	14.5	259	10.2	76	3.0	1	66
AE(S)(F)(P)4(A)(B)773000BDL	7000	3,000	2,213	25	7.5	16.5	294	11.6	76	3.0	1	66
AE(S)(F)(P)4(A)(B)884200B1DL	8000	4,200	3,100	12	11.1	24.5	340	13.4	86	3.6	1	66
AE(S)(F)(P)4(A)(B)884200BDL	8000	4,200	3,100	12	11.1	24.5	340	13.4	86	3.6	1.5	66
AE(S)(F)(P)4(A)(B)885000BDL	8000	5,000	3,700	9	11.1	24.5	340	13.4	86	3.6	1.5	66
AE(S)(F)(P)(X)4(A)(B)896500BDL	8000/9000	6,500	4,800	7	15.7	34.5	378	14.9	101	4.0	1.5	66
AE(S)(F)(P)4(A)(B)898100BDL	8000/9000	8,100	6,000	5	15.7	34.5	378	14.9	101	4.0	1.5	66

* The fifth digit of the model number is "A" for fixed gearcase models and "B" for clutched gearcase models.

- Above data is for clutched gearcase models. For no-clutched models, reduce weight by 1.5 lb (0.7 kg) and length by 2 in (51 mm).

- For Straight Type Tools Choose the Position of the Handle by Adding (L) for Left Side and (R) for Right Side

HT GEARHEAD TOOLS

FEATURES AND BENEFITS

- Custom made to fit virtually any application.
- Same high durability gearing as on AcraDyne's standard HT Series tools.
- Model types available:
 - HT Offset Gearhead tools
 - HT Right Angle with Offset Gearhead Tools
 - HT Right Angle Air Tools with Offset Gearhead
- Torque ranges from 250 Nm to 8,100 Nm.



ACRADYNE® HIGH TORQUE NOSE EXTENSIONS



NOSE EXTENSIONS

FEATURES AND BENEFITS

- Ideal for hard-to-reach applications when a torque tube, or arm, is not desirable.
- Used as a cost-effective, more flexible option to a multiple spindle system.
- Common Applications:
 - Wheel install and repair stations.
 - Large flange assembly



REACTION BARS

Each tool includes a standard spline-attachment reaction device. Custom reaction devices are also available; contact your AIMCO sales representative for more details, 1-800-852-1368.



MODEL	DESCRIPTION
26810	Single Ended, Flat, 6000 Series
26815	Single Ended, 2.375" Offset, 6000 Series
26830	Double Ended, Flat, 6000 Series
26885	Single Ended, 4.00" Offset, 6000 Series
26800	Single Ended, Flat, 7000 Series
27200	Single Ended, 3.10" Offset, 7000 Series
26820	Double Ended, Flat, 7000 Series
26890	Single Ended, 4.00" Offset, 7000 Series
25277	Single Ended, flat, 8000 Series
25274	Single Ended, 3.35" offset, 8000 Series
25275	Single Ended, 4.00" offset, 8000 Series
25278	Double Ended, flat, 8000 Series
25276	Double Ended, 3.35" offset, 8000 Series
27255	Single Ended, flat, 9000 Series
26840	Single Ended, 3.35" offset, 9000 Series

ACCESSORIES

Custom accessories are also available for your application; contact your AIMCO Sales Representative for more details, 1-800-852-1368.



MODEL	DESCRIPTION
26477	Swivel Bail, 6000 Series
26327	Swivel Bail, 7000 Series
25287	Swivel Bail, 8000 Series
26478	Swivel D-Handle, 6000 Series
26328	Swivel D-Handle, 7000 Series
25291	Swivel D-Handle, 8000 Series
26479	Stationary Bail, 6000 series (26336 handle not included)
26332	Stationary Bail, 7000 series (26336 handle not included)
25289	Stationary Bail, 8000 series (26336 handle not included)
26336	Fixed Handle (for use with 26479, 26332, 25289)
26337	Rear Fixed Hoist Ring, 6000/7000/8000 Series Pistols
28514	Rear Folding Hoist Ring Kit for 8000 Series Pistols
28549	Sliding Spindle, 6000 Series
27045	Sliding Spindle, 7000 Series

DC TOOLS: TOOL/SPINDLE SELECTION GUIDE

MODEL	RPM	LENGTH		WEIGHT		TORQUE, Nm																				
		in	mm	lb	kg	5	10	15	20	25	50	75	100	125	150	175	200	225	250	275	300	325	350	375	400	425
ANGLE																										
AEN4C12004B	3,111	11.65	295.9	2.0	0.91																					
AEN4C12009B	1,750	11.00	279.5	2.2	0.91																					
AEN4C12014B	875	11.66	296.4	2.2	1.00																					
AEN4C12018B	691	11.66	296.4	2.2	1.00																					
AEN4C12022B	560	11.66	296.4	2.2	1.00																					
AEN32015C	1481	14.8	376.7	2.7	1.22																					
AEN32025C	833	14.8	376.7	2.7	1.22																					
AEN32030C	803	14.6	371.9	2.8	1.27																					
AEN32040C	574	14.6	371.9	2.8	1.27																					
AEN33042C	1,095	16.6	422.3	4.4	2.00																					
AEN33053C	1,095	16.6	422.3	4.4	2.00																					
AEN33060C	845	19.1	485.7	6.6	2.99																					
AEN33090C	568	19.1	485.7	6.6	2.99																					
AEN33120C	442	21.2	539.0	9.3	4.22																					
AEN33200C	245	23.4	594.4	9.4	4.26																					
AEN33210C	234	23.6	599.9	10.0	4.54																					
AEN33300C	151	23.8	603.8	10.0	4.54																					
AEN35090B	607	22.6	573.7	6.9	3.13																					
AEN35140B	472	22.5	571.9	10.4	4.72																					
AEN35175B	384	22.5	571.9	10.5	4.76																					
AEN35225B	291	22.9	581.1	12.3	5.58																					
AEN35285B	236	22.9	581.1	12.3	5.58																					
AEN35350B	191	22.9	581.1	12.3	5.58																					
INLINE																										
AES4A12003BQ	2,625	11.12	282.7	2.0	0.91																					
AES4A12006BQ	2,625	11.12	282.7	2.0	0.91																					
AES4A12011BV	1,313	11.44	290.5	2.2	1.00																					
AES4A12014BV	1,037	11.44	290.5	2.2	1.00																					
AES4A12018BV	840	11.44	290.5	2.2	1.00																					
AES4A12022BV	656	11.44	290.5	2.2	1.00																					
AES32010CV	2222	14.3	363.7	2.5	1.13																					
AES32020CV	1250	14.3	363.7	2.5	1.13																					
AES32025CV	893	14.3	363.7	3.2	1.45																					
AES32038CV	595	17.2	435.9	4.2	1.91																					
AES33040CV	1314	18.7	475.7	6.4	2.90																					
AES33060CV	883	18.7	475.7	6.4	2.90																					
AES33100CV	489	23.1	585.7	8.1	3.67																					
AES33150CV	329	23.1	585.7	8.1	3.67																					
AES33230CV	221	23.1	585.7	8.1	3.67																					
AES33400CV	122	25.5	647.7	13.0*	5.90*																					
AES33600CV**	82	25.5	647.7	13.0*	5.90*																					
AES35075AV	944	21.9	555.2	9.2	4.17																					
AES35090AV	767	21.9	555.2	9.2	4.17																					
AES35110AV	634	21.9	555.2	9.2	4.17																					
AES35135AV	515	21.9	555.2	9.2	4.17																					
AES35170AV	418	21.9	555.2	9.2	4.17																					
AES35280A	236	24.2	615.1	12.8	5.81																					
AES35350A	192	24.2	615.1	12.8	5.81																					
AES35420A	159	24.2	615.1	12.8	5.81																					
AES35515A****	129	24.2	615.1	12.8	5.81																					
AES35635A****	104	24.2	615.1	12.8	5.81																					

*Includes reaction bar and fixture nut.

**Torque Range: 120-480 Nm Max Torque: 600 Nm

*** Torque Range: 128-515 Nm ****Torque Range: 159-635 Nm

Recommended Torque Range

Max Torque

DC TOOLS: TOOL/SPINDLE SELECTION GUIDE

MODEL	RPM	LENGTH		WEIGHT		TORQUE, Nm																			
		in	mm	lb	kg	5	10	15	20	25	50	75	100	125	150	175	200	225	250	275	300	325	350	375	400
PISTOL																									
AEP4_12003B	2,625	7.6	194.2	2.2	1.00																				
AEP4_12006B	2,625	7.6	194.2	2.2	1.00																				
AEP4_12011BV	1,313	7.5	191.2	2.3	1.04																				
AEP4_12014BV	1,037	7.5	191.2	2.3	1.04																				
AEP4_12018BV	840	7.5	191.2	2.3	1.04																				
AEP4_12022BV	656	7.5	191.2	2.3	1.04																				
AEP4_2020BV	1,313	14.3	363.7	2.4	1.09																				
AEP4_2025BV	1,037	14.3	363.7	2.4	1.09																				
AEP4_2030BV	840	17.2	435.9	2.4	1.09																				
AEP4_2035BV	747	17.2	435.9	2.4	1.09																				
AEP4_2040BV	656	17.2	435.9	2.4	1.09																				
AEP35075AV	944	16.0	405.2	9.2	4.17																				
AEP35090AV	767	16.0	405.2	9.2	4.17																				
AEP35110AV	634	16.0	405.2	9.2	4.17																				
AEP35135AV	515	16.0	405.2	9.2	4.17																				
AEP35170AV	418	16.0	405.2	9.2	4.17																				
AEP35280A	236	18.4	468.2	13.6	6.17																				
AEP35350A	192	18.4	468.2	13.6	6.17																				
AEP35420A	159	18.4	468.2	13.6	6.17																				
AEP35515A*	129	18.4	468.2	13.6	6.17																				
AEP35635A**	104	18.4	468.2	13.6	6.17																				
TUBENUT																									
AET4A12018B	516	11.3	288.1	3.1	1.41																				
AET4A12025B	387	11.3	288.1	3.1	1.41																				
AET4A12025B-KD	387	15.9	402.6	3.1	1.41																				
AET32020C	622	14.8	375.9	3.1	1.41																				
AET32025C	466	15.5	393.7	4.0	1.81																				
AET32035C	347	16.0	406.4	4.5	2.04																				
AET32050C	257	16.4	416.6	5.6	2.54																				

* Torque Range: 128 - 515 Nm **Torque Range: 159 - 635 Nm

HIGH TORQUE SERIES -

MODEL WEIGHT	RPM**	LENGTH			TORQUE, Nm																				
		in	mm	lb	50	100	200	300	400	500	600	850	1100	1200	1300	1500	2000	2500	3000	4000	5000	6500	8100		
()4(A)(B)66200B	315	12	305	12	5.3																				
()4(A)(B)66425B	165	12	305	12	5.3																				
()4(A)(B)66625B	106	11.8	299	12.5	5.7																				
()4(A)(B)66925B	72	11.8	299	12.5	5.7																				
()4(A)(B)771200B	65	11.5	292	12.5	5.7																				
()4(A)(B)773000B	25	12.9	328	18	8.1																				
()4(A)(B)884200B1	12	14.8	376	27	12.3																				
()4(A)(B)884200B	12	14.8	376	27	12.3																				
()4(A)(B)885000B	9	14.8	376	27	12.3																				
()4(A)(B)896500B	7	18.0	457	34	15.0																				
()4(A)(B)898100B	5	18.0	457	34	15.0																				

Recommended Torque Range

Max Torque

ACRADYNE® ACCESSORIES

CABLE ASSEMBLIES

The AcraDyne® DC electric nutrunner tool system uses a single cable to carry all necessary conductors for superior ergonomics and durability.

- Flexible polyurethane cover for maximum durability, abrasion and transmission fluid resistant.
- Quick disconnects at both ends facilitate tool changeover and troubleshooting.
- The CAN data/signal is via RJ45 for products such as the KDM, socket tray or computer.

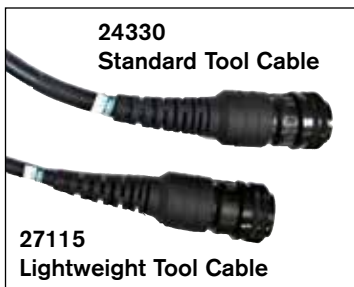

MODEL	DESCRIPTION	LENGTH	
		m	ft
TOOL CABLES			
24330	Cable G3 Tool Cable 3M	3	9.8
25350	Cable G3 Tool Cable 5M	5	16.4
24320	Cable G3 Tool Cable 10M	10	32.8
27110	Cable G3 Tool Cable 3M Lightweight*	3	9.8
27115	Cable G3 Tool Cable 5M Lightweight*	5	16.4
27122	Cable G3 Tool Cable 10M Lightweight*	10	32.8
EXTENSIONS			
24320	Extension cable 10M	10	32.8
25518	Extension cable 20M	20	65.6

*Lightweight cables are for use only with 1000 & 2000 Series tools.

CABLE ADAPTERS AND CONNECTORS

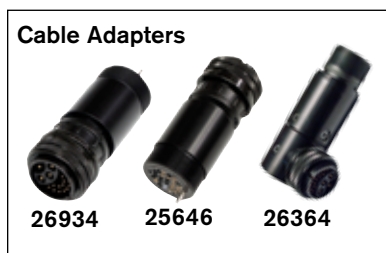

MODEL	DESCRIPTION
ADAPTERS AND CONNECTORS	
25646	G1 iEC to G3 Cable Adapter
26934	G3 iEC to G1 Cable Adapter
27210	G3 Tool to G1 Cable Adapter
26364	Right Angle Cable Adapter
26709	G3 Tool to G1 Cable (Cable Tester only)
26700	Cable Tester Unit, G3
26594	Conversion Kit G1 iEC to G3 iEC
27370	Conversion Kit G3 iEC to G1 iEC
25491	Breakaway Cable Connector – Ensures disconnect of cable should stress in excess of 40 lbs occur

DATA INTERFACE OPTIONS

MODEL	DESCRIPTION
DATA INTERFACE OPTIONS	
	20403 Data/signal cable connects accessories to controller. Length: 7 ft (2.0 m)
	23490 I/O Wiring Connector – Simple Module to facilitate connections to I/O on iEC Controllers
	AEC-CIM Interface module that allows communication between a computer and an AcraDyne® controller through USB or CAN connections. All necessary cables included.

CABLE TESTER UNIT

AcraDyne's cable tester unit helps you diagnose and verify functionality of AcraDyne Tool Cables.



26700

- Eliminate guesswork as to whether cable has been damaged or is functioning within specifications.
- Verifies each specific conductor within the cable for continuity.
- Simple, quick testing facilitates troubleshooting.

ACRADYNE® ACCESSORIES

SOCKET TRAY

- Simply remove the assigned socket to select the application to be run.
- Quick and easy set up. Parameters assigned to socket position automatically.
- Optional self illuminating socket receptacles.
- Delrin® blanks may be easily machined by the customer to accommodate custom socket profiling.
- Nothing to break, wear out, or maintain.
- Proximity sensors detect presence of socket.
- Can also be used with UEC style controllers.

	MODEL	DESCRIPTION
	AMPST-2-I	2 Position Socket Tray for iEC Controllers
	AMPST-4-I	4 Position Socket Tray for iEC Controllers
	AMPST-6S-I	6 Position Socket Tray for iEC Controllers, Straight Line
	AMPST-6-I	6 Position Socket Tray for iEC Controllers
	AMPST-8-I	8 Position Socket Tray for iEC Controllers

SLIDING SPINDLES



MODEL	DESCRIPTION
20712	Sliding Spindle 2" Stroke 2000 Series Tools, 3/8" Drive
20848	Sliding Spindle 2" Stroke 3000 Series Tools, 1/2" Drive

TOOL BAILS

- AcraDyne's spring bails are designed for use with any of the AcraDyne® 1000, 2000, or 3000 Series tools.
- The spring bails snap on quickly and firmly at any place on the body of the tool for perfect balance and secure suspension.

	MODEL	DESCRIPTION
	25501	Wire Bail for 1000 Series Tools
	27594	Stationary Bail for 1000 Series Tools
	27791	Rotating Bail Assembly for 1000 Series Tools
	26568	Cable Bail to Hang Tool Vertically for Gen III Cables
	21208	Spring Bail for 2000 Series Tools
	23662	Rotating Bail for 2000 Series Tools
	23575	Rotating Bail for 3000 Series Tools

TOOL STORAGE

Tool baskets and tool hangers are a great way to keep a tool in place when not being used.

UNIVERSAL TOOL BASKET

Interchangeable among angle head and pistol grip tool models throughout the industry.



VERTICAL TOOL HANGER

Designed for AcraDyne Gen 1 tools.



CONTROLLER BRACKETS



20322



20853



27816

MODEL	DESCRIPTION
20322	Basic wall-mounting plate
20853	Table stand free standing platform
27816	Mounting bracket with internal wireways

MOUNTING BRACKETS

MODEL	DESCRIPTION
25717	Mounting Bracket for 1000 Series Angle Tools
25843	Mounting Bracket for 1000 Series Push-To-Start Tools
26443	Mounting Bracket for Straight and Pistol 1000/2000 Series
24924	Mounting Flange for Straight and Pistol 1000/2000 Series

MODEL	DESCRIPTION
25718	Mounting Bracket for 3000/5000 Series Angle Tools
26570	Mounting Bracket for 3000/5000 Series Straight Tools
25265	Angle head Mounting Bracket (Cradle type) for 3000/5000 Angle Tools over 225 Nm



23730

LIGHT TOWER

Cost- and energy-efficient LED light tower is highly visible from any direction, angle, and distance.

- Two built-in alarms (FB Type) with selectable sound patterns.
- Adjustable Volume (Max. 85 dB at 1 m)
- Tower includes red, yellow, green, blue, and clear lenses.



28489 Light Tower Bracket for Gen IV Controller

ANGLE TOOL BODY JACKETS

Keep your tools protected and avoid accidental damage to the application with AIMCO's tool body jackets.



MODEL	DESCRIPTION
BJ10051	For 1000 series angle tools
BJ10052	For 2015, 2025 series angle tools
BJ10053	For 2030, 2040, 2055 series angle tools
BJ10054	For 3060, 3090 series angle tools
BJ10055	For 3120, 3200 series angle tools

BAR CODE SCANNER



LS4278 Bluetooth®-Enabled Scanner Kit

Sturdy bar code scanners deliver superior scanning, allowing you to easily scan small, stacked, or poorly one-dimensional (1D) printed bar codes. Kit includes a cradle, power supply, and USB/Ethernet cable.

- Scratchproof tempered glass exit window.
- Single-circuit board construction eliminates common inter-connection failures.
- Industrial long-life charging contacts can withstand 250,000+ insertions into cradle.
- Wireless scanner enables users to hold scanner at any angle.

MODEL	DESCRIPTION
LS4208	RS232 Barcode Reader Kit
LS4278	RS232 Wireless Barcode Reader Kit

ACRADYNE® HIGH TORQUE PNEUMATIC TOOLS

FEATURES AND BENEFITS

AcraDyne's High Torque Pneumatic Bolting Tools offer a reliable and dependable solution for the installation and removal of heavy-duty fasteners in a variety of industries that require high torque capability, accuracy, power, and safety.

- Modular design allows for ease of maintenance.
- Motors and gearing are interchangeable.
- Durable and reliable gearbox
- Proven air motor
- Faster free speed
- One-hand reverse



AAP1B66600A



AAP1B76950A



AAP1B771800A



AAP1B885100A



See page 33 for
Air Preparation Units



MODEL	TORQUE (Nm)	TORQUE (Ft-lb)	SPEED (rpm)	WEIGHT (lb)	SQUARE DR. (in)	AIR CONSUMPTION (CFM)
AAP1B66400A	400	300	70	9.75	3/4	22.9
AAP1B66600A	600	450	50	9.75	3/4	22.9
AAP1B66850A	850	625	36	9.75	1	22.9
AAP1B76950A	950	700	37	10.4	1	26.3
AAP1B771350A	1350	1000	22	10.4	1	26.3
AAP1B771800A	1800	1325	15	14.9	1	26.3
AAP1B772950A	2950	2175	9	14.9	1	26.3
AAP1B885100A	5100	3775	7.5	23	1-1/2	31.5

ACRADYNE® HT PNEUMATIC TOOL ACCESSORIES

AIR LINE

AIMCO AIR HOSE

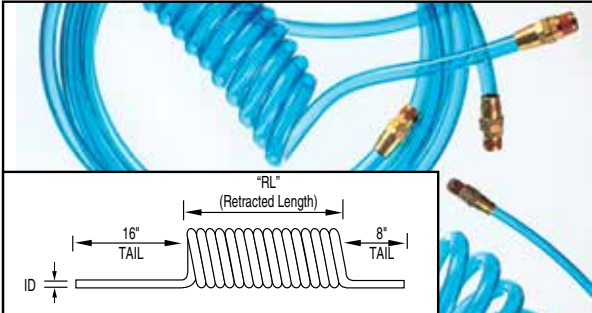

- Durable Polyurethane or Rubber hose.
- Excellent recoil memory.
- Maximum flexibility and light weight.
- Polyurethane available in transparent hose color (opaque available).
- Custom colors available.
- High chemical resistance.

REACTION BARS

Each tool includes a standard spline-attachment reaction device. See page 24 for part numbers. Custom reaction devices are also available; contact your AIMCO Sales Representative for more details, 1-800-852-1368.



Reaction Bars

SINGLE AIR HOSE ASSEMBLIES (COILED)

MODEL WORKING PRESSURE 100 PSI	DESCRIPTION (OD x ID x LENGTH)	RETRACTED LENGTH	NPT FITTINGS
ASH-500C-15MSZ	3/4" x 1/2" x 15'	13"	1/2"
ASH-500C-25MSZ	3/4" x 1/2" x 25'	23"	1/2"

SINGLE AIR HOSE (COILED) CUSTOM LENGTHS

Custom length coil assemblies and special colors are available in minimum order quantities.

STRAIGHT AIR HOSE (SOLD PER FOOT)

MODEL	DESCRIPTION
ASH-500Z	1/2" I.D.

- Assemblies include reusable swivel fitting.
- Burst pressure 428 PSI @ 68° F.
- Working temperature: -104° F to 175° F.
- Straight hose is available by the foot with, or without, hose fittings.
- Ask about full-reel pricing. Call 1-800-852-1368.

AIR HOSE FITTINGS



28161

PLUGS

MODEL	DESCRIPTION
28161	1/2" x 1/4" MPT
28162	1/2" x 3/8" MPT
28163	1/2" x 1/2" MPT
28164	1/2" x 1/2" FPT



27768

QUICK-CHANGE COUPLERS

MODEL	DESCRIPTION
27768	1/2" FPT
27769	1/2" MPT



27771

PROTECTIVE COUPLER

MODEL	DESCRIPTION
27771	Vinyl



BRASS FITTINGS

MODEL	CAPACITY
500-RZ	1/2" NPT Rigid Fitting
500-SZ	1/2" NPT Swivel Fitting

PROTECTIVE COVERS

Durable protective covers prevent marring and damage.



MODEL	DESCRIPTION
BJ10078	Protective Cover, 6000 Series
BJ10077	Protective Cover, 7000 Series
BJ10076	Protective Cover, 8000 Series

AIR PREPARATION UNITS

AFRL STACKING FILTER/REGULATORS

Stacking filter/regulator combinations provide air filtration and precise regulation in a single unit for easy mounting and installation.

FEATURES AND BENEFITS

- All models include L-mount bracket, gauge, and metal bowl shields.
- Polycarbonate filter and lubricator bowls (metal bowls standard on AFRL-8).
- 25-micron filter included on all models.
- Regulating range: 7 – 125 PSI.
- Custom order upgrade items include metal bowl, 5 micron filter, semi-automatic filter drain, and reduced PSI range regulator. Contact an AIMCO sales representative for more information, 1-800-852-1368.

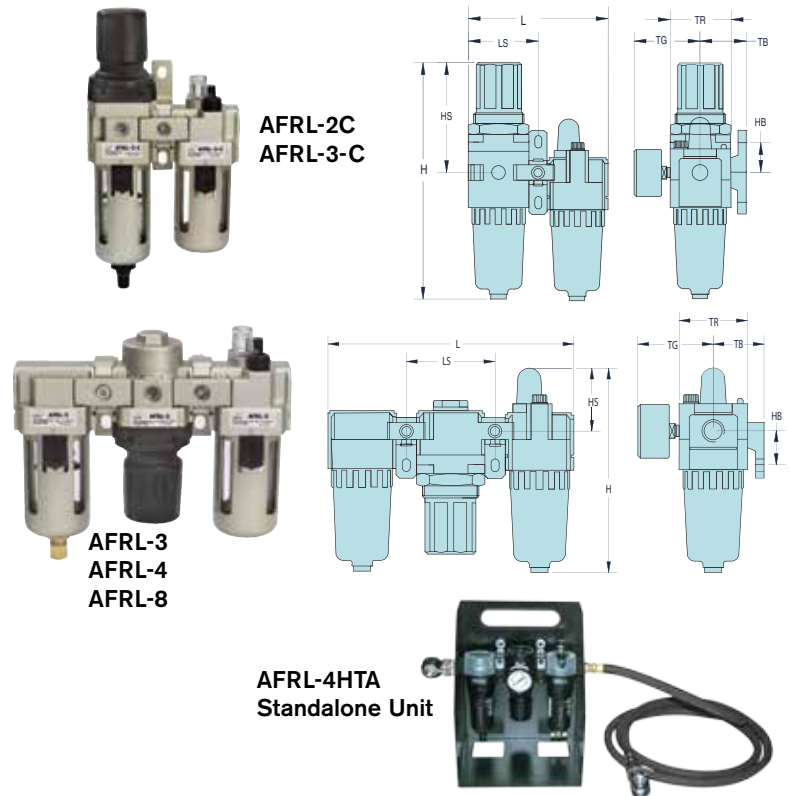

MODEL	PORT	GAUGE PORT	FLOW RATE CFM	L/MIN	BOWL SHIELD	H IN/MM	HB IN/MM	HS IN/MM	L IN/MM	LS IN/MM	TB IN/MM	TG IN/MM	TR IN/MM
AFRL-2	1/4"	1/8"	70	2,000	yes	6.16 (156.5)	1.39 (35.3)	1.50 (38.1)	7.13 (181.1)	2.52 (64.0)	1.61 (41.0)	2.39 (60.7)	2.09 (53.1)
AFRL-2-C	1/4"	1/8"	60	1,700	yes	8.31 (211.1)	1.38 (35.1)	3.64 (92.5)	4.61 (117.1)	2.30 (58.4)	1.61 (40.9)	2.39 (60.7)	2.09 (53.1)
AFRL-3	3/8"	1/4"	140	4,000	yes	7.54 (191.5)	1.57 (40.0)	1.61 (40.9)	9.37 (238.0)	3.31 (84.1)	1.97 (50.0)	2.58 (65.5)	2.76 (70.1)
AFRL-3-C	3/8"	1/4"	105	3,000	yes	10.31 (261.9)	1.57 (39.9)	4.41 (112.0)	6.06 (153.9)	3.03 (77.0)	1.97 (50.0)	2.58 (65.5)	2.76 (70.1)
AFRL-4	1/2"	1/4"	140	4,000	yes	7.54 (191.5)	1.57 (40.0)	1.61 (40.9)	9.37 (238.0)	3.31 (84.1)	1.97 (50.0)	2.58 (65.5)	2.76 (70.1)
AFRL-8	1"	1/4"	180	5,000	yes	10.69 (271.5)	1.97 (50.0)	1.89 (48.0)	11.81 (300.0)	4.13 (104.9)	2.75 (69.9)	2.97 (75.4)	3.54 (89.9)

AIR PREPARATION UNITS: BASIC FUNCTIONS

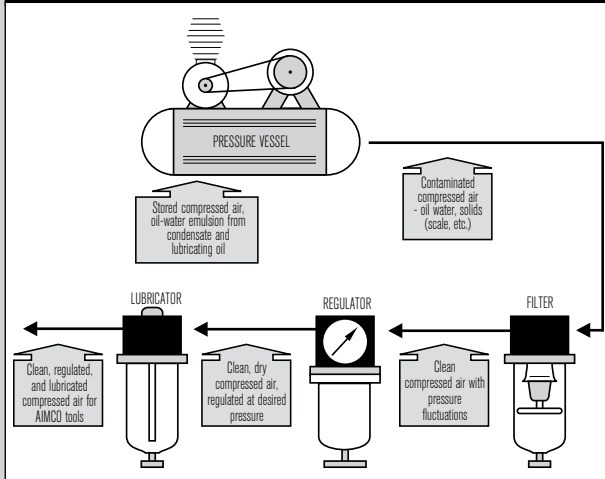

The supply of clean, dry air is essential to the operation of pneumatic powered tools. Use only clean filtered air for longer tool life. Provide proper airflow (CFM) and regulate air pressure (PSI) for optimum performance.

To determine unit size for application, you need to know:

- Total air flow (CFM) required for application.
- Size of incoming air line and size of air line required by tool.
- Air supply pressure (PSI)
- Allowable pressure drop.
- Does the application requires lubrication?
- Does the overall system have the required capacity?



MULTIPLE NUTRUNNING SYSTEMS

AIMCO has the capability to integrate the AcraDyne® tool spindle into a customized Multiple Nutrunning System. From simple systems vertically suspended above the part to assembly stations that integrate with your line, AIMCO can effectively accommodate your project.

LET US KNOW YOUR REQUIREMENTS AND WE WILL PROPOSE A SOLUTION TAILORED TO YOUR NEEDS.



SMALL ENGINE MANUFACTURER

- Air cooled small vehicle engine assembly.
- Ten spindle 2.4 – 2.8 kgf-m.
- Integrated PLC control of system functions.
- Supplied overhead rail follows line and returns powerhead to home position.
- Powerhead features single lever control and visual confirmation of accepted torque.

FEATURES AND BENEFITS

- Nutrunner sequencing - Allows nutrunners to be sequenced at each phase of the tightening process providing even distribution of torque and load to each fastener.
- Even torque distribution - Where there is uneven torque distribution, part damage or distortion could occur with possible fastener failure or loss of residual clamp load.
- Snug, threshold, final torque in one pass - No need for multiple torque stage sequencing. Fixtured nutrunners save time and effort.
- No missed fasteners - With multiple nutrunners there is a spindle dedicated to each location, ensuring quality on every rundown on every bolt.
- Better residual torques - Synchronized controlled fastening allows residual torque levels to be consistent with the dynamic torque specification.
- Saving in cycle time - Compared to using a single nutrunner tool with many rundowns, running all fasteners simultaneously reduces in-station cycle time.
- Cost saving benefits - Saving installation cycle time frees operators to handle additional tasks and potentially reduce labor costs.
- Collect data – Most common methods of collecting data for quality control and statistical analysis can be implemented from a serial data string using RS232 to formatted data from a network database.

ENGINE MANUFACTURER

- Gasoline generator assembly.
- Six spindle 30 Nm
- Replaced hand assembly with rotation pattern to simultaneous rundown.

AUTOMOTIVE MANUFACTURER

- Wheel lug nut assembly.
- Four spindle 105 Nm
- Rotating spindle trunnion.
- Replaced competitive system.
- Built-in PC for data storage.
- Custom display panel showing application.
- Cpk range of 3.2 – 6.9 far exceeds quality requirements.



TORQUE MEASUREMENT: OVERVIEW

TORQUE MEASUREMENT AND THE VERIFICATION OF TORQUE TOOLS AND APPLIED TORQUE ARE AN INTEGRAL PART OF TODAY'S THREADED ASSEMBLY PROCESS. The method used to measure torque can affect the judgments made regarding tool performance, assembly processes and overall product quality.

DYNAMIC TORQUE

The torque produced during the actual tightening process, normally measured using rotary transducers and a torque analyzer.

Advantages:

- Reduces operator influence.
- Measures applied torque.
- Can also include angle of rotation as error proofing parameter.

RESIDUAL TORQUE

The torque measured by producing an incremental amount of movement of the fastener after the actual tightening process, normally measured using a dial or digital torque wrench.

Advantages:

- Easy access to fastener.
- Error proofing.
- Can detect missed fasteners or joints with significant relaxation.

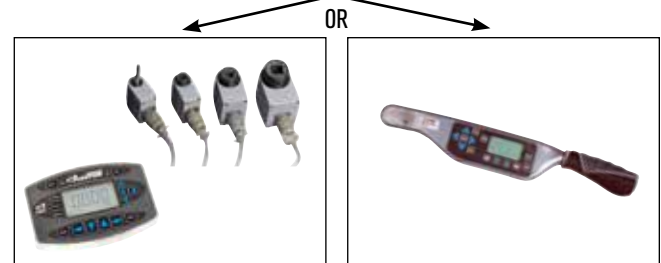
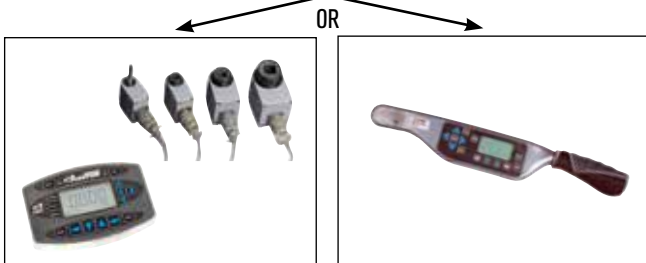
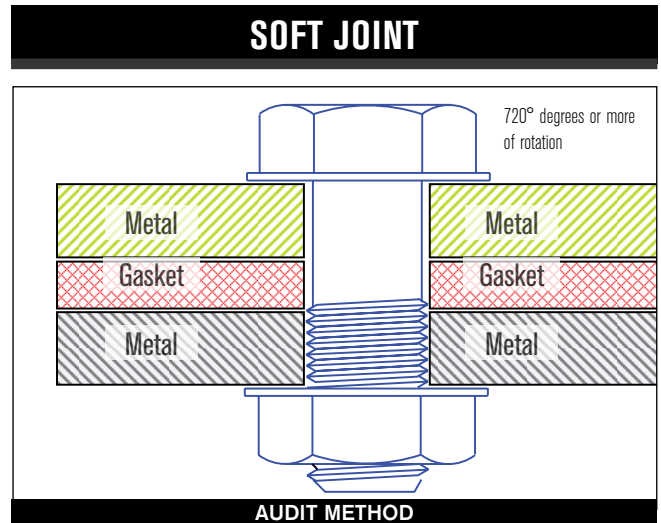
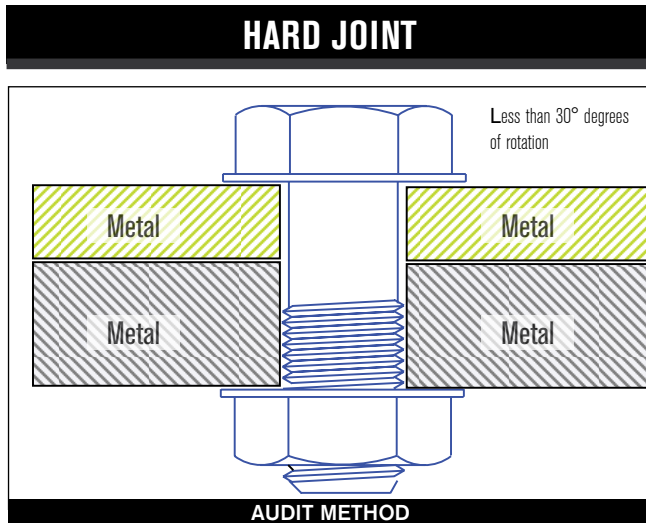

Dynamic Torque: 15 Nm

Residual Torque: 18 Nm

Dynamic Torque: 15 Nm

Residual Torque: 12 Nm

Values as examples only

Values as examples only

A hard joint, one requiring a low degree of rotation during tightening, will normally show very little relaxation after tightening. Due to the high amount of remaining clamp load and friction within the joint members, additional movement of the fastener requires additional torque energy to be applied. Therefore, Residual Torque values will be higher than Dynamic Torque values.

A soft joint, one requiring a high degree of rotation during tightening, will normally show significant amounts of relaxation after tightening. Relaxation leads to a loss of clamp load and friction within the joint members. Due to this relaxation, additional movement of the fastener requires relatively small amounts of additional torque energy and Residual Torque values will be lower than Dynamic Torque values.

TORQUE MEASUREMENT: OVERVIEW

CHECKING TORQUE MEASUREMENT BEFORE, DURING, AND AFTER ASSEMBLY ENSURES QUALITY MANUFACTURING. Proper torque measurement is critical in many assembly operations. AIMCO utilizes years of experience to design a process around your specific auditing requirements. From simple dial wrenches to electronic data collectors and joint analyzers for R&D, AIMCO is with you every step of the way.

BEFORE ASSEMBLY – TOOL CAPABILITY

Is the tool working correctly?

Testing and verifying tools under controlled conditions. Identify the accuracy & repeatability of the tool before using it in production.

Equipment used:

- Desktop testers with internal transducers.
- Auditor™ analyzers with either stationary or rotary transducers.
- UFT hydraulic joint simulators and rotary transducers.

PRODUCTS TO USE...



DURING ASSEMBLY – PROCESS CAPABILITY

How does the tool work with the product being assembled?

Testing the tools during the actual process helps ensure that the process is working correctly. This is where variables in the parts and influences from the operator can be accounted for.

Equipment used:

- Torque Data Collectors/Analyzers
- Auditor™ Rotary Transducers



AFTER ASSEMBLY – PRODUCT CAPABILITY

Does the finished product meet the user's expectations?

Checking the product after assembly is the final opportunity to check the product prior to user delivery. This is the way to verify that product quality is satisfactory.

Equipment used:

- Click/Dial wrenches
- Electronic wrenches with Auditor™ analyzers.
- Rotary transducers and Auditor™ analyzers with hand driver to move fastener.



TORQUE MEASUREMENT: OVERVIEW

MEASURING QUALITY – PROCESS CAPABILITY

STATISTICAL ANALYSIS IS AN IMPORTANT STEP IN ANY QUALITY CONTROL PROCESS.

One of the most widely accepted statistical indicators of process quality, and therefore product quality, is Cpk, or the process capability for a centered process. This value indicates how capable a process is and whether the results of that process are properly centered near a specific target. A capable process is one that approaches, as a limit, 100% conformance to specifications.

Cpk is a statistical value that indicates how tightly grouped a series of samples is around the target value. Cpk is a function of the Upper Specification Limit (USL), the Lower Specification Limit (LSL), the mean of the samples and the standard deviation (σ) of the samples.

$$Cpk = \text{either } \frac{(USL - \text{Mean})}{(3 \times \sigma)} \text{ or } \frac{(\text{Mean} - LSL)}{(3 \times \sigma)}, \text{ whichever is smaller.}$$

An acceptable, or capable, process will normally have a Cpk value of at least 1.33.

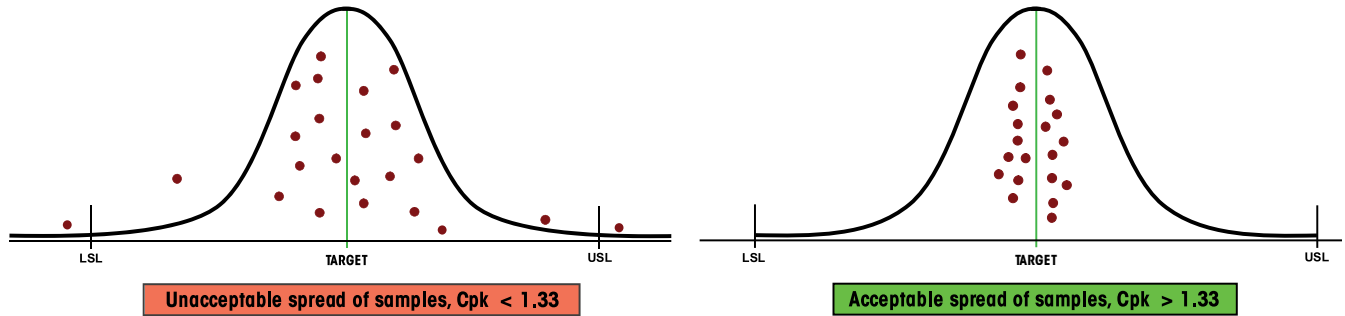

MEASURING QUALITY – CLAMP LOAD

THE PURPOSE OF THREADED FASTENING IS TO PRODUCE THE CORRECT AMOUNT OF CLAMP LOAD WITHIN THE JOINT.

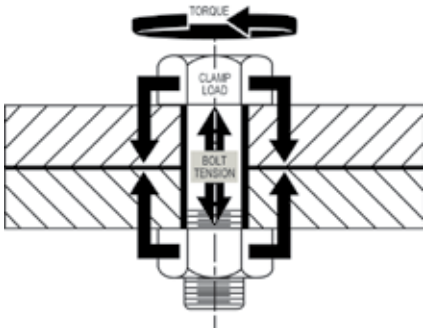

Due to the cost and difficulty of measuring clamp load during the actual assembly process, torque is used as the control parameter during tightening. Many manufacturers use torque values as the primary indicator of threaded assembly quality. However, achieving repeatable clamp load is a better indicator of joint quality.

Studies have shown that discontinuous drive tools can produce equal or better clamp load results when compared to continuous drive tools.

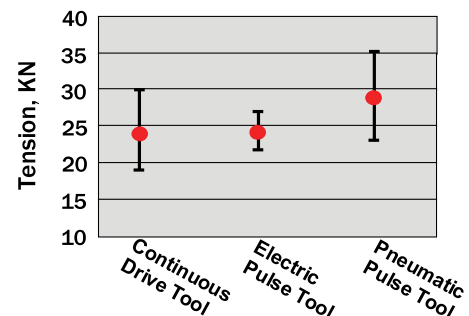
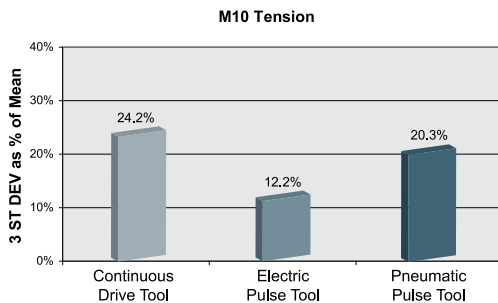

TORQUE MEASUREMENT SYSTEMS



TORQUE MEASUREMENT SYSTEMS

Devices	Model Series	Data Collector	Integrated Transducer	Torque Wrench	Torque Wrench Loader	External Transducer Port	Stationary Transducers -Smart	Stationary Transducers -Ind Std	Rotary Transducer -Smart	Rotary Transducer - Ind Std
Tester	ATC		X							
	AUET		X							
	AUET-DC	X	X							
	AUET/MTM		X			X				
	AUET/MTM-DC	X	X			X				
Analyzer	ATDA					X				
	ATDA-DC	X				X				
	ATDA-8000 -10-DCA(-TA)(-TP)	X				X				
	ADET	X				X				
	DataTouch3	X				X				
Wrench	ADW			X						
	ADW-DC	X								
	APTW			X						
	ATW			X						
	ATWL				X					
	FRDM3	X		X						
	FWE			X						
Transducer	ARTIS									X
	ASTIS							X		
	AISI						X			
	AISF						X			
	AIRI								X	
	AIRF								X	
	ARTB (Bluetooth)									X
ASTB (Bluetooth)								X		
Run-down Fixtures	AJKR									
	AJKS									
	ARDFA									
	ARDIA									
	ARDA (Spline Drive)									
Joint Simulator	UFT									
Test Stands	AHCTS*	X*	X*	X*			X*	X*	X*	X*
	AHCTS-K*	X*	X*	X*			X*	X*	X*	X*
	AHDTS*	X*	X*	X*			X*	X*	X*	X*
	AHBTS*	X*	X*	X*			X*	X*	X*	X*
	AIMTS*	X*	X*	X*			X*	X*	X*	X*
Torque Cart	iTVC*	X*	X*	X*			X*	X*	X*	X*
	FTY*									
	MSB*	X*	X*	X*			X*	X*	X*	X*

*configured to customer specifications





TORQUE MEASUREMENT TESTERS

TORQUE MEASUREMENT: TESTERS

Features and Benefits

- Heavy Industrial Design
- All Software included
- Auditor Torque Testers are designed for intuitive and functional usability. AUET/MTM models are available with our unique dual integrated torque transducer package.

Testers are designed to audit torque wrenches and power tools, including pulse tools

					
	ATC	AUET	AUET/MTM	AUET-DC	AUET/MTM-DC
Auditor Torque Cube		Auditor Universal Electronic Tester	Auditor Universal Electronic Tester - Multiple Transducer Module	Auditor Universal Electronic Tester - Data Collector	Auditor Universal Electronic Tester - Multiple transducer Module - Data Collector
Compact vertical or horizontal bench-mount tester.		Bench mount or line side tester utilizing integrated transducer.	Bench mount or line side tester with dual integrated transducer and external transducer capacity.	Bench mount or line side tester utilizing integrated transducer. Provides data collection capability with included software to interface with PC.	Bench mount or line side tester with dual integrated transducer and external transducer capacity. Provides data collection capability with included software to interface with PC.
Integrated Transducer Range (values are in full scale)	100 in/oz - 1,000 ft/lbs 1 - 1,350 Nm	100 in/oz - 750 ft/lbs 1 - 1,000 Nm	100 in/oz - 750 ft/lbs 1 - 1,000 Nm	100 in/Oz - 750 ft/lbs 1 - 1,000 Nm	100 in/oz - 750 ft/lbs 1 - 1,000 Nm
External Transducer Capacity (transducer sizes exceeding this range may be special ordered)			up to 5,000 ft-lbs		up to 5,000 ft-lbs
Vertical / Horizontal Mount	X				
Bi-directional accuracy of +/- X of indicated reading within the top 90% of the Tester's capacity	1%	0.50%	0.50%	0.50%	0.50%
Data Output to PC	X	X	X	X	X
Integrated Torque Transducer	1	1	2	1	2
External Transducer Port			X		X
Number of stored readings	999	999	999	999	999
Adjustable rundown fixture included *	1	1	2	1	2
Rechargeable NiMH Battery	X	X	X	X	X
Measurement Modes					
Peak	X	X	X	X	X
First Peak (Click)	X	X	X	X	X
Pulse	X	X	X	X	X
Track	X	X	X	X	X
Units of Measure Options	8	8	8	8	8
Tool Manager Software Included				X	X

* Included with all testers and analyzers with a range up to 1000 in/lbs.

TORQUE MEASUREMENT TESTERS USED IN CONJUNCTION WITH

External Transducers

	ATC	AUET	AUET/MTM	AUET-DC	AUET/MTM-DC
ASTIS - Stationary			X		X
ARTIS - Rotary			X		X

Switch box for External Transducer

	ATC	AUET	AUET/MTM	AUET-DC	AUET/MTM-DC
AISWT-4L > 4 Way Intellect box			X		X
AISWT-6L > 6 Way Intellect box			X		X

Cables

	ATC	AUET	AUET/MTM	AUET-DC	AUET/MTM-DC
ICBL-USB - USB Serial > PC	X	X	X	X	X
ATDBLIS - IS Transducer w/angle (10 Pin)			X		X
ATDBRIS - IS Transducer (4 Pin)			X		X
ICBL-10P - Intellect transducer cable Identification chip in cable - 10 pin connector			X		X
ICBL-4P - Intellect transducer cable. Identification chip in cable - 4 pin connector			X		X

AUDITOR™ TORQUE CUBE™



ATC-10
ATC-25
ATC-100
ATC-250
ATC-500



ATC-250F
ATC-750F



AUDITOR™ TORQUE CUBE™

The Auditor Torque Cube (ATC) is a compact, versatile desktop tester and provides a multitude of capabilities. The ATC is designed to test hand or power tools with the following:

- Peak, first peak and track modes.
- Multiple engineering units.
- Manual and auto clear function.
- Multiple frequency response settings.
- Bi-directional use and accuracy.
- Accuracy is better than 1% of indicated reading top 90% of range.
- Serial data output.
- Memory 999 data samples.
- Battery and/or mains powered.

Because precision and quality are critical, you can depend on our testers to calibrate and certify your tools. Whether you are assembling large complicated systems or small precise time pieces, AIMCO provides the best system for your application. Our instruments have been judged “best in class” by independent National Standards laboratories. Auditor Torque Cube is rugged enough to test and verify tools at “point of use” while still being accurate enough to calibrate hand and power tools.

Each tester is shipped with a mains/battery charger power cord, a hex to allen drive bit, and a bolting template. Models with max torque of 1,000 ft-lb or less also include a joint rundown fixture. The ATC can be positioned vertically or horizontally for the ergonomic testing of inline or pistol grip tools.

MODEL	RECOMMENDED TORQUE RANGE		WEIGHT		W X H X D		SQUARE DRIVE
	Nm	in-lb	kg	lb	mm	in	in
ATC-10	0.13 - 1.13	1 - 10	1.13	2.5	79 x 95 x 83	3.13 x 3.75 x 3.25	1/4
ATC-25	0.28 - 2.83	2.5 - 25	1.13	2.5	79 x 95 x 83	3.13 x 3.75 x 3.25	1/4
ATC-100	1.13 - 11.3	10 - 100	1.13	2.5	79 x 95 x 83	3.13 x 3.75 x 3.25	1/4
ATC-250	2.83 - 28.3	25 - 250	1.13	2.5	79 x 95 x 83	3.13 x 3.75 x 3.25	3/8
ATC-500	5.65 - 56.5	50 - 500	1.13	2.5	79 x 95 x 83	3.13 x 3.75 x 3.25	3/8
ATC-250F	34 - 340	25 - 250 ft-lb	2.25	5	79 x 95 x 83	3.13 x 3.75 x 3.25	1/2
ATC-750F	101.7 - 1017	75 - 750 ft-lb	2.25	5	79 x 95 x 83	3.13 x 3.75 x 3.25	3/4

AUDITOR™ BENCH MOUNT TESTERS



AUET



AUET/MTM



AUET/MTM-DC

AUDITOR™ UNIVERSAL ELECTRONIC TESTERS

The Auditor Universal Electronic Testers (AUET) have a broad range of features to accommodate most requirements. These instruments are designed to be bench top mounted and are available in several configurations and various single or multiple torque ranges. They are also available with file capability (DC) models. The DC models require PC software Auditor Tool Manager (ATM).

These AUET instruments utilize the same transducers that are featured in the ATC instruments, providing the same high quality accuracy and durability. The common interface makes the Auditor tester extremely user friendly.

Instruments up to 1,000 in-lb are supplied with rundown adapters/joint kits. Rundown kits for larger instruments can be ordered separately. AUET/MTM units are supplied with an external transducer port and selector switch for connecting additional transducers.



SINGLE TRANSDUCER MODELS

MODEL**	RECOMMENDED TORQUE RANGE	
	In-oz/In-lb	kgf-cm/Nm
AUET-0100(-DC)	10 - 100 in-oz	0.7 - 7.2 kgf-cm
AUET-10(-DC)	1 - 10 in-lb	1.1 - 11.5 kgf-cm
AUET-50(-DC)	5 - 50 in-lb	0.5 - 5.6 Nm
AUET-100(-DC)	10 - 100 in-lb	1.1 - 11.3 Nm
AUET-250(-DC)	25 - 250 in-lb	2.8 - 28.3 Nm
AUET-500(-DC)	50 - 500 in-lb	5.7 - 56.5 Nm
AUET-1000(-DC)	100 - 1,000 in-lb	11.3 - 113 Nm
AUET-1200(-DC)	120 - 1,200 in-lb	13.6 - 135.6 Nm

DUAL TRANSDUCER MODELS

MODEL**	RECOMMENDED TORQUE RANGE			
	Transducer 1	Transducer 2	Transducer 1	Transducer 2
AUET/MTM-10-100(-DC)	1.0 - 10 in-lb	10 - 100 in-lb	0.11 - 1.12 Nm	1.3 - 11.3 Nm
AUET/MTM-50-250(-DC)	5.0 - 50 in-lb	25 - 250 in-lb	0.56 - 5.65 Nm	2.8 - 28.3 Nm
AUET/MTM-50-500(-DC)	5.0 - 50 in-lb	50 - 500 in-lb	0.56 - 5.65 Nm	5.65 - 56.5 Nm
AUET/MTM-100-500(-DC)	10 - 100 in-lb	50 - 500 in-lb	1.13 - 11.3 Nm	5.65 - 56.5 Nm
AUET/MTM-100-1000(-DC)	10 - 100 in-lb	100 - 1,000 in-lb	1.13 - 11.3 Nm	11.3 - 113 Nm

*Custom sizes are also available, please inquire. **Add "-DC" to part numbers for data collecting models.

Data collecting models allow multiple files/tools/applications to be associated with torque data. Requires Tool Manager software.

AUDITOR™ TORQUE MEASUREMENT ANALYZERS

TORQUE MEASUREMENT: ANALYZER

Features and Benefits

- Auditor Torque Analyzers share similar features across all products and are designed for intuitive and functional usability.
- Connects to AIMCO's line of rotary and stationary transducers



ATDA

ATDA-DC

Auditor Torque Data Analyzer

Auditor Torque Data Analyzer with Data Collection

Portable analyzer to be connected to various transducers

Portable analyzer to be connected to various transducers. Provides data collection capability with included software to interface with PC

Bi-directional	X	X
Data Output to PC	X	X
External Transducer Port	1	1
Number of stored readings	999	999
Rechargeable NiMH Battery	X	X
Digital I/O for external devices	X	X
Measurement Modes	X	X
Peak	X	X
First Peak (Click)	X	X
Pulse	X	X
Track	X	X
Measurement Units	8	8
Software Included		X
Firmware		
LAB - Line Side Auditing		
SPC - Quality Control		
Barcode Reader	X	X
Bluetooth Wireless Option		

USED IN CONJUNCTION WITH

Transducers

AISI / AISF - Digital		
ASTIS - Stationary	X	X
ASTB - Stationary Wireless		
ARTIS - Rotary	X	X
ARTIS2 - Rotary		
ARTB - Rotary Wireless		

Wrenches

ATW	X	X
FWE		





Switch boxes for External Transducers

AISWT-4L > 4 Way Intellect box	X	X
AISWT-6L > 6 Way Intellect box	X	X

Cables

ICBL-USB - USB Serial > PC	X	X
ATDBLIS - IS Transducer w/ angle (10 Pin)	X	X
ATDBRIS - IS Transducer (4 Pin)	X	X
ICBL-10P - Intellect transducer cable. Identification chip in cable - 10 pin connector	X	X
ICBL-4P - Intellect transducer cable. Identification chip in cable - 4 pin connector	X	X
ICBL-8000DIG - Connect from ATDA-8000 series analyzer to AISI / AIFI transducer		
RMC Cable DT.ET		
FWE Cable DT.ET		

AUDITOR™ TORQUE MEASUREMENT ANALYZERS

			
ATDA-8000	ATDA-8000-10-DCA(-TA)(-TP)	ADET	DataTouch3
Auditor Torque Data Analyzer with 7" screen	Auditor Torque Data Analyzer -10" display with Data Collection. TA = Torque & Angle, TP = Torque & Pressure	Auditor Torque Data Analyzer with Data Collection	Torque and Angle Data Collector designed to operate with SQnet software
7" screen with high resolution display and intuitive user interface	10" touch screen with high resolution display and intuitive user interface with multiplexer	Portable with 2.8" touchscreen that displays graphical data with zoom/plot features. 1 GB memory	Portable with 2.8" touchscreen that displays graphical data with zoom/plot features. 1 GB memory
X	X	X	X
X	X	X	X
4	4	1	1
999	999	20,000	20,000
X	X	X	X
X	X	X	X
X	X	X	X
X	X	X	X
X	X	X	X
X	X	X	X
X	X	X	X
8	8	8	8
X	X	X	X
		X	X
			X
X	X		X
		X	
		X	
		X	
			X
X	X	X	X
		X	X
		X	X

AUDITOR™ TORQUE DATA ANALYZERS



ATDA-DC

AUDITOR™ TORQUE DATA ANALYZERS

The Auditor Torque Data Analyzer (ATDA) DC is designed to be portable or conveniently placed on a bench. Depending on requirements, the tester can be connected to various transducers. In addition, it can be connected to transducerized wrenches, rotary or stationary transducers. The user interface is common between the ATC (Cube), AUET, AUET-DC, AUET/MTM, AUET/MTM-DC, ATDA, and ATDA-DC. All of these instruments have similar menus. Additionally, all data collector testers utilize Auditor Tool Manager for tool testing and data management.

The Auditor Torque Data Analyzer is available in two configurations:

- ATDA: A simple torque analyzer with sequential memory, 999 data samples, engineering limits, limited statistical processing average, range, Cp and CpK with serial output.
- ATDA-DC: Contains all of the features of the ATDA and has additional file capability. It can associate data with file names and manage data collection with a computer and Auditor Tool Manager software.



This is a great “starter” tool management system. It provides testing, archiving, and analysis of tools at single or multiple torque targets. The tool and torque data is stored in a SQL database and can be exported to Excel or any .csv spreadsheet.

MODEL	DESCRIPTION
ATDA	Auditor Torque Data Analyzer
ATDA-DC	Auditor Torque Data Collector

AUDITOR™ TORQUE DATA ANALYZERS



ATDA-8000

ATDA-8000-10-DCA(-TA)(-TP)

TOUCH SCREEN AUDITOR™ TORQUE DATA ANALYZERS

Auditor offers the ATDA-8000 and the ATDA-8000-10-DCA(-TA)(-TP). The ATDA-8000 is a touch screen instrument with a high resolution display and user interface that facilitates “point of use” tool validation. The user interface is intuitive and the display provides clear easy to read data. Features and parameter settings are password protected to ensure parameters cannot be inadvertently changed. After initial setup, the instrument provides semi-automatic tool validation and judgment.

The ATDA-8000 is a single channel instrument. The ATDA-8000-10-DCA(-TA)(-TP) is a larger instrument that includes a multiplexor for connection to multiple transducers allowing a wide range of tools to be tested with one instrument. The (-TA) model is designed for torque and angle analysis and the (-TP) model is designed for torque and pressure analysis.

Both the ADTA-8000 and the ATDA-8000-10-DCA(-TA)(-TP) systems work with AIMCO’s line of digital transducers.

MODEL	DESCRIPTION
ATDA-8000	Auditor Torque Analyzer Single channel 7" touch screen point of use validation system
ATDA-8000-10-DCA(-TA)(-TP)	Auditor Torque Analyzer Multiple transducer 10" touch screen point of use validation system



AUDITOR™ TORQUE DATA ANALYZER

Auditor Data Analyzer provides a simple way to monitor nutrunners and torque wrenches on the assembly line. This quick, simple data collector provides an economical alternative to the DataTouch Data Analyzer.

Features and Benefits

- Full-color touchscreen for easy navigation.
- Graphical display with zoom/plot features for inspecting charts and graphs on the analyzer.
- Transducer auto-recognition reduces set-up time.
- Bluetooth wireless (Advanced).
- Embedded LAB firmware makes it easy to create quality tool strategies.
- Simple transfer of data to PC using F3 Explorer software for data storage.
- 1 GB memory stores multiple test strategies and data.
- Li-Ion battery with 8 hour life.
- Available in two versions:
 - Basic - ADET
 - Advanced - ADETB
- Advanced version connects with wireless transducers and printers, then exports data using system software.

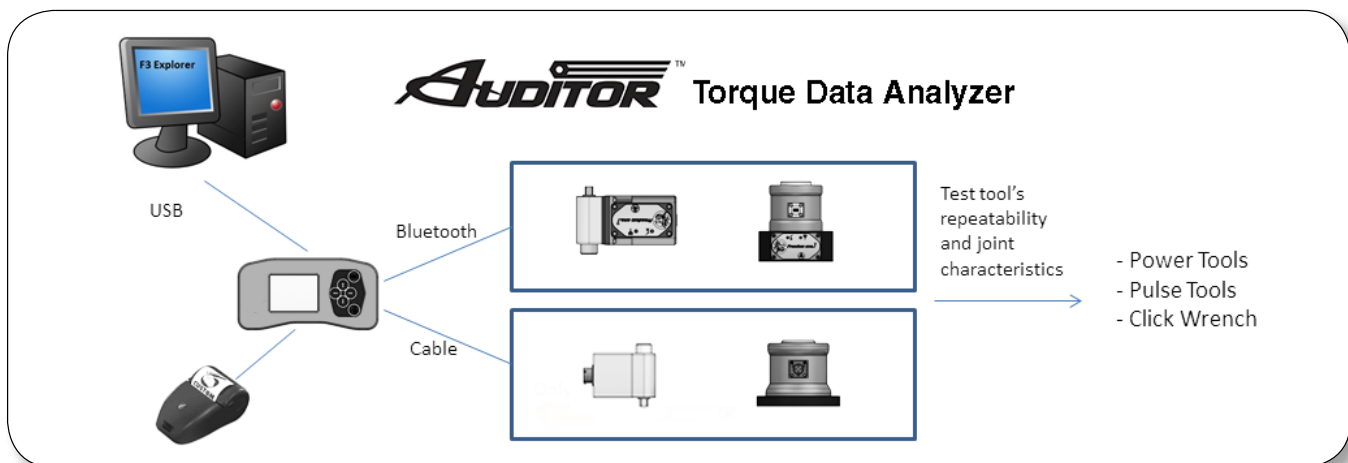

Specifications

Internal Memory: 1 GB
20,000 results, 20,000 curves,
1,000 programs

High-resolution 2.3" touchscreen, 320 x 240 pixels,
65,535 colors



DATATOUGH3 DATA ANALYZER

DataTouch3 is a torque/angle data collector designed to operate with SQnet software. Test tightening tools by connecting stationary or rotary transducers. Test joints by connecting the FWE Wrench.



DataTouch3

Features and Benefits

- Full-color touchscreen for easy navigation.
- Graphical display with zoom/plot features for inspecting charts and graphs on the wrench.
- Transducer auto-recognition reduces set-up time.
- WiFi and Bluetooth options for cableless communication with transducer and laptop.
- Keyboard for navigation and switching on/off.
- Program advanced tightening strategies with easy input steps.
- Embedded firmware (LAB and SPC) targets quality functions.
- 1 GB memory enables storage of all test parameters, results, and curves.
- Li-Ion battery with 8-hour life.
- Optional bar code reader for data traceability.

SQnet software provides protection protocols and allows user to define routes linked to location and tool ID. User downloads events to wrench, performs tasks and sends results back that can be graphed or charted so that statistics can be analyzed.



Specifications

Internal Memory: 1 GB
20,000 results, 20,000 curves,
1,000 settable programs

High-resolution 2.8" touchscreen,
320 x 240 pixels, 65,535 colors

Dimensions

Length	215 mm
Width	144 mm (with battery cap)
Depth	63 mm
Weight	750 g + 90 g (belt)



Battery

Power Supply

- Li-Ion changeable battery
3.6 V, 2700 mA
- 9 hours battery life
- 6 hours to recharge
battery by PC USB port
- 4 hours to recharge
battery using external
battery charger (optional)

AUDITOR™ TOOL MANAGER/AUDIT MANAGER

AUDITOR™ TOOL MANAGER SOFTWARE

Tool Manager Software is included with the purchase of AUET-DC and AUET/MTM-DC data-collecting torque testers, as well as the ADW-DC data-collecting torque wrench. Create a database of tools and store test results with this easy-to-use software integrator to/from tester to PC.

Tool Manager Software

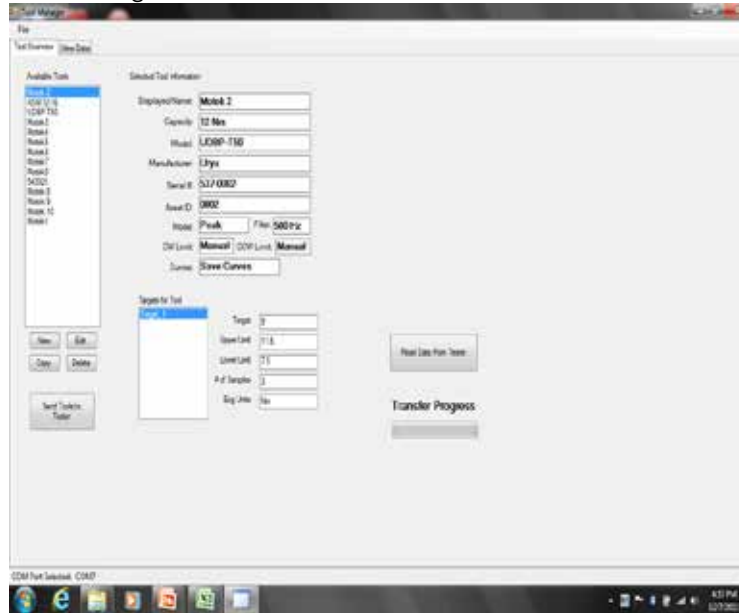

AUDITOR™ AUDIT MANAGER SOFTWARE

Audit Manager Software is included with the purchase of ATDA-DC data collecting torque analyzers. The View Data tab allows you to look at the collected data and the trace file. This data can be exported to Excel as a .csv file and displayed by Excel charts. The trace file displays the data in a torque/time graph and allows the user to supersede the move-on reading selected by the wrench by visually discerning via the trace where the fastener started to rotate. When selecting a single job the average, range, sigma, Cp, and CpK values are listed.

Audit Manager Software

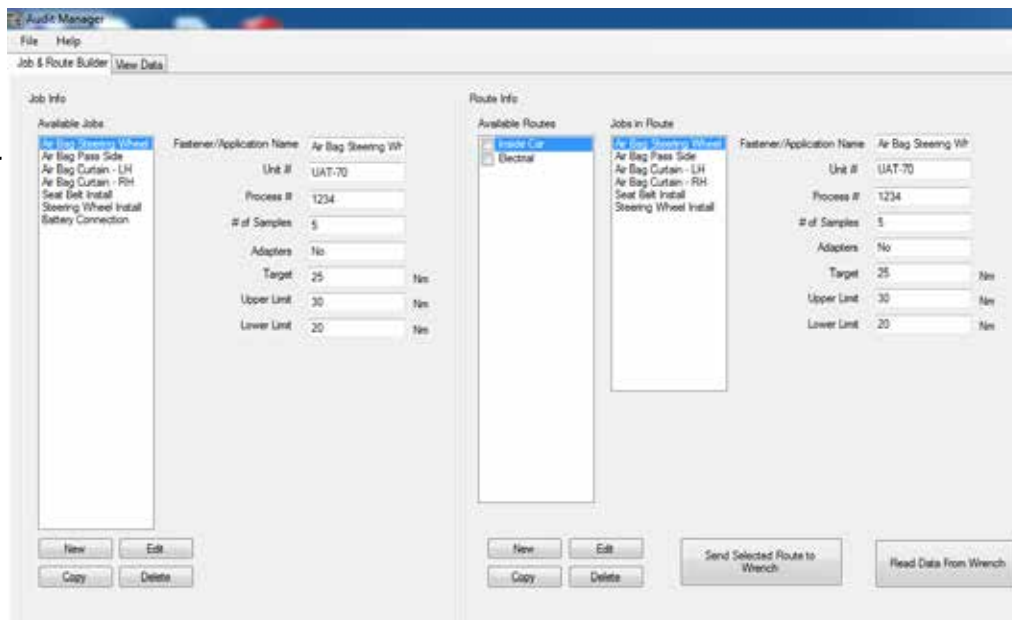





AUDITOR™ HIGH CAPACITY TEST STANDS

TORQUE MEASUREMENT: HIGH CAPACITY TEST STANDS

Features and Benefits

- Advanced test stations for larger tools and higher torque output
- Configured to meet application requirements
- Durable industrial grade devices

					
	AHCTS	AHCTS-K	AHDTS	AHBTS	AIMTS
	Auditor High Capacity Test Stand	Auditor High Capacity Test Stand - Hydraulic	Auditor High Capacity Test Stand Dual Transducer	Auditor High Capacity Stand w/variable joint simulation	Auditor High Capacity Impact Test Stand
	Designed for testing tools with continuous rotating output spindles and pulse tools.	Specifically designed for hydraulic wrenches testing.	Two transducers, one for rotary tools and one for hydraulic tools. Includes rundown & reaction fixtures with a single display.	Designed for testing rotating tools without the use of rundown fixtures. Adjustable airbrake joint simulation eliminates CCW rotation after rundown.	Ideal for testing impact wrenches and is recommended to utilize rundown fixtures when testing impacts.
Capacity	6,750 Nm	33,750 Nm	33,750 Nm	6,750 Nm	2,700 Nm

ACCESSORIES

Rundown fixtures					
AHCTS-3/4RDF		X		X	
AHCTS-1RDF		X		X	
AHCTS-1.5RDF		X		X	
Insert Square Drive Adapters					
CA1510	1-1/2" Male to 1" Female	X		X	
CA1550	1-1/2" Male to 1/2" Female	X		X	
CA1575	1-1/2" Male to 3/4" Female	X		X	
CA2510I	2-1/2" Male to 1" Female	X		X	
CA2515I	2-1/2" Male to 1-1/2" Female	X		X	
CA2575I	2-1/2" Male to 3/4" Female	X		X	
CA150108DHD	1-1/2" Male to 1-1/2" Male Hex		X		

Please refer to the Test Stand Configurator in Appendix C on 94 for required ordering options.

AUDITOR™

AUDITOR™ HIGH-CAPACITY TEST STANDS



AHCTS-5000

AHCTS TEST STAND FOR ROTATING TOOLS

Designed for testing tools with continuous rotating output spindles. The test stand includes a rundown fixture, bushing for side load support, reaction post or reaction paddles, transducer and torque analyzer display.

MODEL	DESCRIPTION
AHCTS-0500	3/4" Square Drive w/rundown fixture
AHCTS-2500	1.5" Square Drive w/rundown fixture
AHCTS-7500	1.5" Square Drive w/rundown fixture
AHCTS-5025*	1.5" Sq Dr dual station w/rundown fixture and reaction devices

*This stand has two transducers embedded into the base, one for rotary tools and one for hydraulic tools, and comes with rundown and reaction fixtures and one display.

**Please refer to 94 for required ordering options.

Optional Pelican Case shown (ordered separately)



25503



AHCTS-001K

AHCTS-K STAND FOR HYDRAULIC TOOLS

The AHCTS-K stands are specifically designed for hydraulic wrench testing. Hydraulic wrenches have very low profiles but very high torque output, therefore, working height must be minimized to prevent side loading which could lead to errors in data or damage to tool or reaction devices.

Either stand can be ordered with options such as extension legs, casters, embedded or attached torque analyzers with various rundown fixtures and reaction devices. Contact an AIMCO Customer Service Associate for additional information, 1-800-852-1368.

MODEL	DESCRIPTION
AHCTS-0.5K	3/4" Square Drive w/reaction device
AHCTS-001K	1" Square Drive w/reaction device
AHCTS-2.5K	1.5" Square Drive w/reaction device
AHCTS-005K	1.5" Square Drive w/reaction device
AHCTS-010K	1.5" Square Drive w/reaction device
AHCTS-025K	2" Square Drive w/reaction device

AUDITOR™ HIGH-CAPACITY TEST STANDS

AIMTS TEST STAND FOR IMPACT TOOLS

THESE TEST STANDS ARE DESIGNED TO TEST IMPACT WRENCHES, AND ARE COMPATIBLE WITH ANY AUDITOR TORQUE ANALYZER. IT IS NECESSARY TO BOLT THE AIMTS TO A BENCH. WE ALSO RECOMMEND THAT A RUNDOWN FIXTURE ALWAYS BE USED FOR TESTING IMPACTS.



AIMTS-0500
Test stand for small impact tools



AIMTS-2000
Test stand for large impact tools

MODEL	DESCRIPTION
AIMTS-0500	3/4" square drive impact test stand
AIMTS-2000	1.5" square drive impact test stand

Please refer to the Test Stand Configurator in Appendix C on page 72 for required ordering options.

AHBTS TEST STAND WITH BRAKING SYSTEM FOR ROTATING TOOLS

These test stands are for testing rotating tools without requiring the use of rundown fixtures. We utilize an airbrake for testing tools that cannot or should not be used in reverse. These test stands are compatible with any Auditor Torque Analyzer.







AHBTS-2500
Auto Release test stand for quickly testing large rotating tools

MODEL	DESCRIPTION
AHBTS-2500	1.5" square drive, brake system w/reaction device, rotary transducer and display
AHBTS-5000	1.5" square drive, brake system w/reaction device, rotary transducer and display

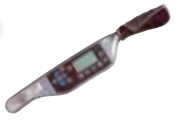
AUDITOR™ TORQUE WRENCHES

TORQUE MEASUREMENT: TORQUE WRENCH

Features and Benefits						
	ADW	ADW-DC	APTW	ATW	Freedom3 Digital Wrench	FWE
	* Auditor Digital Wrench	* Auditor Digital Wrench with Data Collection	Auditor Preset Torque Wrench	Auditor Torque Wrench	Freedom3 Torque/Angle Wrench	Electric Torque Wrench
Torque Range	7 - 370 ft/lbs 10 - 500 Nm	7 - 370 ft/lbs 10 - 500 Nm	4 - 250 ft/lbs 5 - 340 Nm	4 - 148 ft/lbs 5 - 200 Nm	1.1 - 885 ft/lbs 1.5 - 1,200 Nm	1.1 - 885 ft/lbs 1.5 - 1,200 Nm
Bi-Directional accuracy of +/- X of indicated reading within the top 90% of the Tester's capacity	1%	1%	3%	0.50%	1%	1%
Software Included	X	X			X	
Digital wrench with multiple head options for line side testing/auditing	Digital wrench with multiple head options for line side testing/auditing. Data Collector	Interchangeable heads. Preset uses proprietary adjustment tool to guard against unauthorized setting changes	Transducer on a stick. Communicates with Data Collector Testers and Analyzers	Freedom3 offers a uniquely complete tightening solution with large color touchscreen and 1 GB of memory	Transducerized wrench communicates with DataTouch Analyzer (required)	

USED IN CONJUNCTION WITH

ATDA(DC) Data Analyzer				X		
AUET(DC) Tester				X		
AUET/MTM(DC) Tester				X		
DataTouch3 Data Analyzer						X

TORQUE WRENCH LOADERS



For Calibration of all types of torque wrenches eliminating human variable for more accurate measurement - digital transducer used with ATDA-8000-10-DCA

ATWL-250	Torque range up to 250 ft/lbs
ATWL-750	Torque range up to 750 ft/lbs
ATWL-1000	Torque range up to 1000 ft/lbs

See Appendix B on page 70 to configure wrench with options.

AUDITOR™ DIGITAL WRENCH SERIES



ADW-0010K111312222



ADW DATA COLLECTING TORQUE WRENCH

- Large memory capacity.
- Every torque value has associated trace file.
- “Pick a Point” and “Move On” feature.
- Barcode scanner.
- Alpha Numeric screen for entering text.
- Field replaceable batteries.
- Docking station connection.
- Serial connection.
- Battery charger connection.
- Ergonomic handle.
- Switch between measure and data collection modes at any time.
- Multiple files and route capability.
- Data memory and simple statistics “On Board”.
- Complete statistical analysis, data archiving and exporting in Audit Manager software.
- Five models standard ranges 10 - 500 Nm full scale.
- Torsion transducer – not length dependent.
- Transducer is replaceable.
- 1,400 Nm model uses different handle design.

MODEL	TORQUE RANGE		WEIGHT		OVERALL LENGTH		SO. DRIVE
	NM	FT-LB	LB	KG	IN	MM	IN
ADW-0010K	1 - 10	0.7 - 7.4	2.2	1	18	457.2	1/4
ADW-0075K	7.5 - 75	5.5-55	3.1	1.4	23.5	596.9	3/8
ADW-0180K	18 - 180	13-130	3.6	1.6	30.1	765.2	1/2
ADW-0270K	27 - 270	20-198	3.6	1.6	30.1	765.2	3/4
ADW-0500K	50 - 500	37-369	4	1.8	36	914	1
ADW-1400F	140 - 1,400	103-1,033	4.8	2.2	60	1524	1

Unit accuracy is $\pm 1.0\%$ FSD of indicated reading for the top 95% of full scale as indicated above.

Each model includes a case, a battery charger, and a standard square-drive head. Other heads are available at additional cost.

*Part numbers with K, D or F followed by a 1 designate models with file and route capability. K followed by 2 indicate sequential memory but no file capability.

Part numbers with K, D or F followed by a 1,1 indicate file and route with bar code and docking station capability. K, D or F followed by a 1,2 indicate file and route capability with serial port only.

Please refer to the Wrench Configurator in Appendix B on page 70 for required ordering options.



DOCKING STATION

- Nest for accepting all wrench sizes.
- Charger and serial communication accomplished through docking station.
- Bench mountable.

AUDITOR™ ELECTRONIC TORQUE WRENCHES

ALLOW PRECISE TIGHTENING AND AUDITING OF YOUR ASSEMBLY APPLICATIONS



“TRANSUCERS ON A STICK”

- Non-Length Dependent – Where the operator’s hand is positioned during use has no effect on torque readings.
- Available in Industry Standard (IS) or Intelligent (Intellect) Configurations – Transducer is compatible with a wide variety IS style instruments or Auditor™ Intellect instruments that self recognize the transducer.
- Durable – Steel, Aluminum and Carbon Fiber construction providing optimal strength and weight characteristics. Transducer supplied with overload capacity of 150% of full scale.
- Accurate – Torque readings are accurate to 1% of indicated reading in top 95% of full scale.

MODEL	TORQUE RANGE		SQUARE DRIVE
	Nm	ft-lb	in
ATW-0100F	14-136	10-100	3/8
ATW-0200F	27-272	20-200	1/2
ATW-0500F	68-680	50-500	3/4
ATW-1000F	136-1360	100-1000	1

Unit accuracy is $\pm 0.5\%$ of indicated reading for the top 90% of full scale as indicated above.
Required Accessory: ATDBRIS IS cable to connect Auditor™ ATDA instrument.

AUDITOR™ PRESET TORQUE WRENCHES

FEATURES AND BENEFITS

- Easy-to-use preset wrenches for fastener torque auditing.
- Torque ranges from 5 – 340 Nm.
- User friendly, sleek, ergonomic design.
- Tactile feedback on achievement of preset torque.
- Proprietary adjustment tool guards against unauthorized setting changes.
- Wide range of interchangeable heads provide flexibility and convenience.
- +/- 3% accuracy when used in clockwise or counterclockwise directions.



Preset Wrenches	Description
APTW-25	Auditor Preset Torque Wrench, 5 - 25 Nm, Accepts 12 mm Inserts
APTW-50	Auditor Preset Torque Wrench, 10 - 50 Nm, Accepts 12 mm Inserts
APTW-100	Auditor Preset Torque Wrench, 20 - 100 Nm, Accepts 12 mm Inserts
APTW-150	Auditor Preset Torque Wrench, 30 - 150 Nm, Accepts 12 mm Inserts
APTW-200	Auditor Preset Torque Wrench, 40 - 200 Nm, Accepts 14 mm Inserts
APTW-340	Auditor Preset Torque Wrench, 60 - 340Nm, Accepts 14 mm Inserts

Ratchet and Square Drive Heads	Description
APTH-12RT25	Auditor Preset Torque Wrench Ratchet Insert, 1/4 SQ DR, 12 mm
APTH-12RT38	Auditor Preset Torque Wrench Ratchet Insert, 3/8 SQ DR, 12 mm
APTH-12RT50	Auditor Preset Torque Wrench Ratchet Insert, 1/2 SQ DR, 12 mm
APTH-14RT50	Auditor Preset Torque Wrench Ratchet Insert, 1/2 SQ DR, 14 mm
APTH-14RT34	Auditor Preset Torque Wrench Ratchet Insert, 3/4 SQ DR, 14 mm
APTH-12SD25	Auditor Preset Torque Wrench SQ DR Insert, 1/4 SQ DR, 12 mm
APTH-12SD38	Auditor Preset Torque Wrench SD DR Insert, 3/8 SQ DR, 12 mm
APTH-12SD50	Auditor Preset Torque Wrench SQ DR Insert, 1/2 SQ DR, 12 mm
APTH-14SD50	Auditor Preset Torque Wrench SQ DR Insert, 1/2 SQ DR, 14 mm



Open End Heads	Description
APTH-120E7	Auditor Preset Torque Wrench Insert 7 mm OE, 12 mm
APTH-120E8	Auditor Preset Torque Wrench Insert 8 mm OE, 12 mm
APTH-120E9	Auditor Preset Torque Wrench Insert 9 mm OE, 12 mm
APTH-120E10	Auditor Preset Torque Wrench Insert 10 mm OE, 12 mm
APTH-120E11	Auditor Preset Torque Wrench Insert 11 mm OE, 12 mm
APTH-120E12	Auditor Preset Torque Wrench Insert 12 mm OE, 12 mm
APTH-120E13	Auditor Preset Torque Wrench Insert 13 mm OE, 12 mm
APTH-120E14	Auditor Preset Torque Wrench Insert 14 mm OE, 12 mm
APTH-120E15	Auditor Preset Torque Wrench Insert 15 mm OE, 12 mm
APTH-120E16	Auditor Preset Torque Wrench Insert 16 mm OE, 12 mm
APTH-120E17	Auditor Preset Torque Wrench Insert 17 mm OE, 12 mm
APTH-120E18	Auditor Preset Torque Wrench Insert 18 mm OE, 12 mm
APTH-120E19	Auditor Preset Torque Wrench Insert 19 mm OE, 12 mm
APTH-140E13	Auditor Preset Torque Wrench Insert 13 mm OE, 14 mm
APTH-140E14	Auditor Preset Torque Wrench Insert 14 mm OE, 14 mm
APTH-140E15	Auditor Preset Torque Wrench Insert 15 mm OE, 14 mm
APTH-140E16	Auditor Preset Torque Wrench Insert 16 mm OE, 14 mm
APTH-140E17	Auditor Preset Torque Wrench Insert 17 mm OE, 14 mm
APTH-140E18	Auditor Preset Torque Wrench Insert 18 mm OE, 14 mm
APTH-140E19	Auditor Preset Torque Wrench Insert 19 mm OE, 14 mm
APTH-140E21	Auditor Preset Torque Wrench Insert 21 mm OE, 14 mm
APTH-140E22	Auditor Preset Torque Wrench Insert 22 mm OE, 14 mm
APTH-140E24	Auditor Preset Torque Wrench Insert 24 mm OE, 14 mm
APTH-140E27	Auditor Preset Torque Wrench Insert 27 mm OE, 14 mm
APTH-140E30	Auditor Preset Torque Wrench Insert 30 mm OE, 14 mm
APTH-140E32	Auditor Preset Torque Wrench Insert 32 mm OE, 14 mm
APTH-140E34	Auditor Preset Torque Wrench Insert 34 mm OE, 14 mm
APTH-140E36	Auditor Preset Torque Wrench Insert 36 mm OE, 14 mm
APTH-140E38	Auditor Preset Torque Wrench Insert 38 mm OE, 14 mm
APTH-140E41	Auditor Preset Torque Wrench Insert 41 mm OE, 14 mm

SCS WRENCHES

TORQUE MEASUREMENT: SCS WRENCHES

Features and Benefits

- Torque and Angle Measurement
- Wireless Communication (optional)
- Use as a production wrench or for quality control with high-resolution touch screen display storing data points and curves for quick viewing or transfer to PC



	Freedom3 DIGITAL WRENCH	FWE TA	FWE
Torque Range	11 - 740 ft/Lbs 15 - 1000 Nm	11 - 740 ft/Lbs 15 - 1000 Nm	11 - 740 ft/Lbs 15 - 1000 Nm
Performance/Display	1GB Memory stores 20,000 values / 20,000 curves / 1,000 parameter sets, 80 Mips CPU, 32-Bit processor HiRes 2.3" Touch-screen display, 320 x 240 pixel resolution Li-Io rechargeable battery 3.6V 2700mAh, 9 hrs charge	-	-
Bi-directional Measurement accuracy of + / -	.5% in top 80% of range 1.0% in top 90% of range 0.1% display deviation of angle	-	-
Firmware			
LAB: Use to create tests on wrench, then store results including curves on wrench. These results can be downloaded to PC via F3 Explorer	X	X	X
SPC: Jobs and routes are developed for QC and Production via SQnet and downloaded/uploaded to/from wrench	X	X	
PRW: Used as production tool - communicating on-line via radio, BT or Wi-Fi where results are published in real time using VPG software	X		
Software			
F3 Explorer: Collects data results/curves > edit/export to Excel	X	X	
SQnet: Transfers jobs and routes data to/from device to PC	X	X	
VPG: Real time data transfer via wireless communication	X		
Options (must include with tool purchase)			
Barcode Reader Integrated (optional)	X		
Bluetooth Module Integrated Beneficial in PRW mode to communicate with VPG Software	X		
WiFi Module Integrated Beneficial in PRW mode to communicate with VPG Software	X		

ACCESSORIES

Battery Cradle	X		
USB Cable	X		
External Battery Charger	X		
Body Jacket	X		

WRENCH USED IN CONJUNCTION WITH

DataTouch		X	X
-----------	--	---	---

FREEDOM RATCHETS AND SOCKETS

Reversible ratchet	X	X	X
Open end ratchet	X	X	X
Ring end ratchet	X	X	X
Ring open	X	X	X
Recognition chip option	X	X	X

SCS FREEDOM3 WRENCH

The Freedom3 Wrench offers a uniquely complete tightening solution. Its patented angle measuring system, large color touchscreen, and internal 1 GB memory, make it the best performing and flexible torque/angle wrench on the market.

Features and Benefits

- Full-color 2.8" touchscreen provides a graphical display with zoom/plot features for easy viewing.
- Vibration and LED visual queues advise when target torque/angle is reached, reducing the risk of overtightening.
- Save time by creating a tightening strategy on the wrench without connecting to a PC.
- Capable of communicating with PLC and system network where collected data can be stored.
- Auto-recognition of insert head assures accuracy is maintained when interchanging head inserts of differing length.
- Docking station for safe storage and easy battery recharge.
- Bar code reader for efficient route management and data output (optional).
- Wireless technology (optional) synchronizes routes and data from multiple locations on the production line, enabling real-time analysis.
- Two firmware options enable the wrench to work on a wide range of production/assembly applications
 - SPC/LAB Firmware for laboratory analysis and quality control testing.
 - PRW Firmware for production line or rework stations.
- Long battery life provides up to 8 hours of continuous operation.



FRDM3-100



Specifications

Capacity 1.5–1,200 Nm (90% of full scale)
 Output 1GB memory stores 20,000 Values with Curves over 1,000 Parameter sets

Repeatability

Torque +/- 1% accuracy when used in top 90% of wrench range.
 Angle +/- 0.1% display deviation of angle

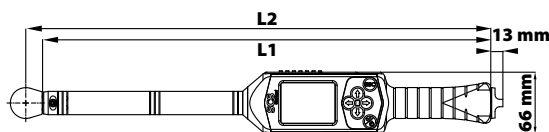

Model	Capacity		Drive mm	L1* mm	L2* mm	Weight*	
	Nm	Ft-Lb				lb	kg
FRDM3-15	15	11	9 x 12 female	375	393	1.8	0.8
FRDM3-30	30	22	9 x 12 female	375	393	1.8	0.86
FRDM3-70	70	52	9 x 12 female	480	498	2.1	0.93
FRDM3-100	100	74	9 x 12 female	480	498	2.1	0.93
FRDM3-200	200	148	14 x 18 female	604	629	3.3	1.5
FRDM3-300	300	221	14 x 18 female	754	779	4.1	1.86
FRDM3-400	400	295	14 x 18 female	754	779	4.1	1.86
FRDM3-600	600	442	14 x 18 female	1,032	1,057	8.0	3.65
FRDM3-800	800	590	Ø20 male	1,250	1,330	11.2	5.1
FRDM3-1000	1,000	737	Ø20 male	1,520	1,610	13.8	6.25
FRDM3-1200	1,200	885	Ø28 SA female	1,732	1,578	15.4	7.0

* without ratchet

Call for quote on devices with larger capacities

FRDM3 models include predisposition for battery cradle and auto recognition of inserted socket on wrench

SCS FREEDOM3 WRENCH

Freedom3 Wrench is available as a Quality or Production wrench, enabling it to work on a wide range of production/assembly applications.

- Quality: SPC/LAB Firmware for laboratory analysis and quality control testing.
- Production: PRW Firmware for production line or rework stations.

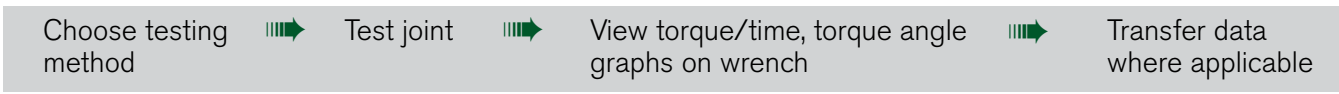

Tightening Strategy – Quality

With Freedom3 Wrench, tightening strategies can be monitored using techniques designed to minimize joint elongation of typical breakaway testing. New breakaway methods employ an algorithm to protect real breakaway point and produce similar results regardless of operator influence.

- **Breakaway Angle**
Preset angle 1–4° and wrench will return torque value reached at the specified angle of rotation.
- **Smart Breakaway Angle**
Preset angle but returns either First Peak or Residual Torque values. See graph of typical hard joint curve.

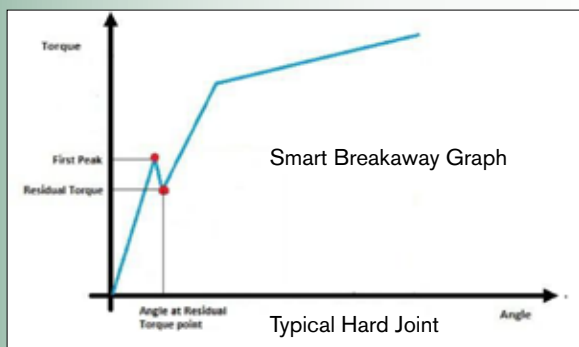

- **Breakaway Open/Close**
Rotate joint CCW a specific degree of angle then retighten CW the same rotation value to move bolt back to original position. Wrench returns torque value at the preset rotation parameter.
- **Minimum Torque**
Validate that the joint meets established torque parameter by setting angle rotation value. Wrench returns pass/fail value.
- **Joint Analysis**
Wrench will sense yield point and produce joint curves and save as yield torque, yield angle, max torque and angle at max torque. Graphic display assists in defining best tightening strategy.

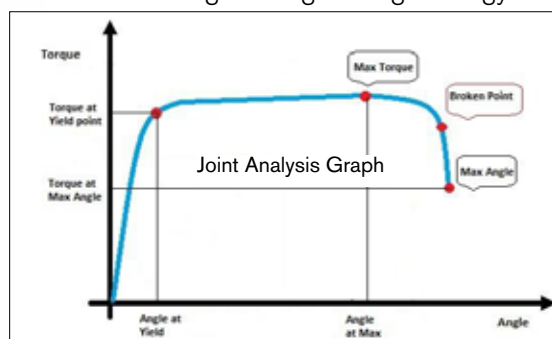

Tightening Strategy – Production

The Freedom3 Wrench is designed to work in real-time as an assembly tool on the production line.

- Wrench operates as a transducerized hand held nutrunner in production.
- Use for critical fastening duties with precise torque control.
- Visual display of torque data including curves.
- Create a route (list of tightening programs) using SQNet software building parameters necessary for any production process.
- Real time data transfer to quality system through VPG software.
- Use as backup tool.

SCS FWE/FWETA ELECTRONIC WRENCH

The FWE Wrench is an economic alternative to the Freedom3 Wrench. FWE utilizes the same high-quality firmware/software programs and can be cabled to the DataTouch Data Analyzer.

Features and Benefits

- Cabled torque wrench measures torque or torque/angle for simplified testing of critical joints.
- 11 standard models offer a range of 1.5 to 1,200 Nm to accommodate a wide range of applications.
- Available with internal memory for automatic recognition when connected to the DataTouch3.
- Standard end-fittings 9 x 12 or 14 x 18 allow the use of standard bits.



Freedom FWE 30



Freedom FWE or FWE TA

Use in conjunction with



DataTouch3 Analyzer

Specifications

Capacity 1.5–1,200 Nm (wrenches capable of function within top 90% of full scale)

Model	Function
FWE TA	Torque/Angle
FWE	Torque only

Model	Capacity		Drive in
	Nm	ft-lb	
Freedom FWE(TA) 15	15	11	9 x 12
Freedom FWE(TA) 30	30	22	9 x 12
Freedom FWE(TA) 70	70	52	9 x 12
Freedom FWE(TA) 100	100	74	9 x 12
Freedom FWE(TA) 200	200	148	14 x 18
Freedom FWE(TA) 300	300	221	14 x 18
Freedom FWE(TA) 400	400	295	14 x 18
Freedom FWE(TA) 600	600	442	14 x 18
Freedom FWE(TA) 800	800	590	Ø20
Freedom FWE(TA) 1000	1,000	740	Ø20
Freedom FWE(TA) 1200	1,200	885	Ø28

FWE models measure torque. FWE-TA models measure torque/angle.
Call for quote on devices with larger capacities

TORQUE CARTS

TORQUE MEASUREMENT: TORQUE CARTS

Features and Benefits

- Test on repeatable joint simulators or production joints
 - Simple to sophisticated options
 - Manual or self-propelled
 - Mobile test carts can be configured for testing continuous and discontinuous drive tools that include DC electric, clutch, battery, impulse, and torque wrenches
 - Each cart is customizable to meet testing needs from 1 - 1,356 Nm
- Contact your AIMCO representative for a quote or more information



iTVC

FTY

MSB

Hydraulic Braking Technology

- Dry braking with multiple hydraulic cylinders where thrust is generated equally to allow better linear control of the braking ramp
- Programmable joint characteristics for use with continuous drive tools - no unwinding required after testing

UFT Repeatability Joint Simulator

- Mechanically adjustable hydraulic pressure circuits allow the bolt tightening body to be configured to simulate various joint characteristics
- Ideal for repeatable, linear joint rate simulation while testing all tools including impulse tools

DataPro Software

Torque Wrench Loader Option

X

X

X*

X*

X

X

X

X

X

X

* Optional equipment - extension added to cart

AUDITOR TORQUE CART



iTVC Torque Cart

AIMCO offers torque carts for “lineside” or “point of use” tool validation and calibration. Our torque carts allow testing of tools on repeatable joint simulators and “in process” use on production joints, allowing users to identify process capability. There are multiple torque cart options:

- Manual push carts equipped with simple torque testers.
- Manual push carts equipped with data collectors and database application software.
- Self propelled cart with computer and relational database application.
- Driven cart with computer and relational database application.

Each cart can be equipped to specific customer requirements. Maximum torque range on board torque cart is 1,000 ft-lb or 1,356 Nm. Ancillary test stands up to 50,000 ft-lb available.

SCS TORQUE CART

High-precision torque carts able to simulate a fastener in all conditions



MSB Torque Cart



FTY Torque Cart

The FTY Torque Cart includes all of the features and benefits of the MSB Torque Cart, *plus* hydraulic braking technology for better linear control of the braking ramp.

Features and Benefits

- ISO 5393, VDI 2862, ISO 6789, VDE 2647
- Sophisticated DataPro software
- Time saving testing of tools with the same tightening strategy as used on production line
- Comparative test analysis
- Lightweight



Specifications

- USB interface
- Sampling frequency of up to 30 kHz with settable filter up to 3 kHz
- Accuracy of 0.5% within top 90% of full scale
- Tests power tools up to 1,356 Nm

DATA COLLECTION SOFTWARE

DATAPRO SOFTWARE - TORQUE CART DATA MANAGEMENT

As the data management system for the AIMCO Torque Cart line, DataPro and SQnet software provide tool management, verification, and calibration. Users can manage complete tool inventory, create jobs/routes, and store collected data. Calibration sequencing can be scheduled by time or number of rundowns.

TORQUE VERIFICATION

DataPro displays sample values of torque, angle, and pulse count. It calculates statistics: average, Cp, Cpk, Six Sigma, and Mean variation. As values are measured, they are graphically plotted on a X-bar range chart scaled to specification limits.

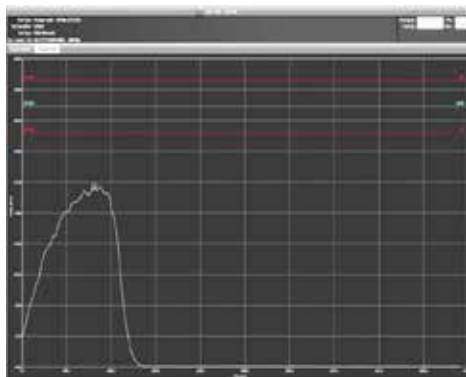

Torque Values from a Click Wrench

TRACES

The axis of the trace can be torque/time, torque/angle, angle/time. Save a trace, retrieve it, and overlay a new trace for comparison. Trace details are displayed at the bottom of the graph: max. values, plot time (ms), number of data points, filter frequency, and sample rate.

DATABASE INFORMATION

View operation lists and associated tools along with historic test or quality data. From the historic data screen, launch statistical graphs to view and analyze archived data. Graphs include X-bar range, histogram, Six Sigma, Cp, and Cpk graphs.

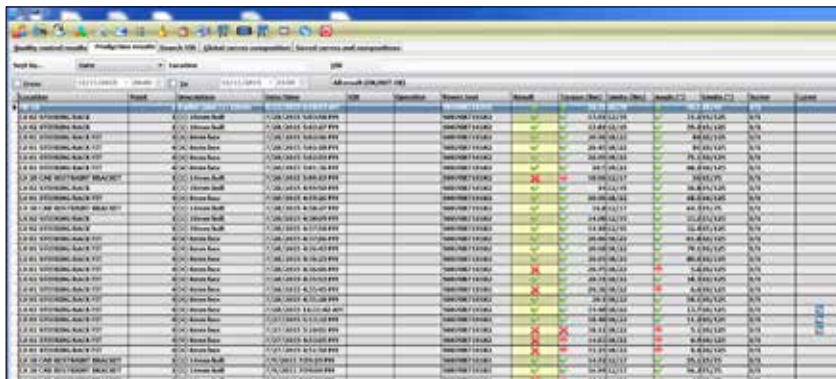
A screenshot of the DataPro software interface showing a table of production test results. The table has multiple columns including 'Job No.', 'Tool No.', 'Tool Name', 'Tool Location', 'Tool Status', 'Test Date', 'Test Time', 'Test Result', 'Operator', 'Inspector', 'Pass/Fail', 'Remarks', and 'Printed'. The table contains many rows of data, with some cells highlighted in green and red. There are also some icons and buttons visible in the interface.

Database Displaying Production Test Results

SQNET SOFTWARE - QUALITY CONTROL AND PRODUCTION LINE

SQnet is designed to manage quality control of the production line, manage all the tools (supplier, models, technical specifications), and manage related quality-control tests (Cm, Cmk, and XR charts).

SQnet software communicates with Freedom3 wrench and DataTouch3 data analyzer to gather audit data from predetermined jobs and routes.

For Quality use, the software enables you to manage tools, operation locations, and quality-control of production lines.

For Production use, you can check residual torque or perform joint analysis in order to test bench settings and to set accurate tightening parameters.

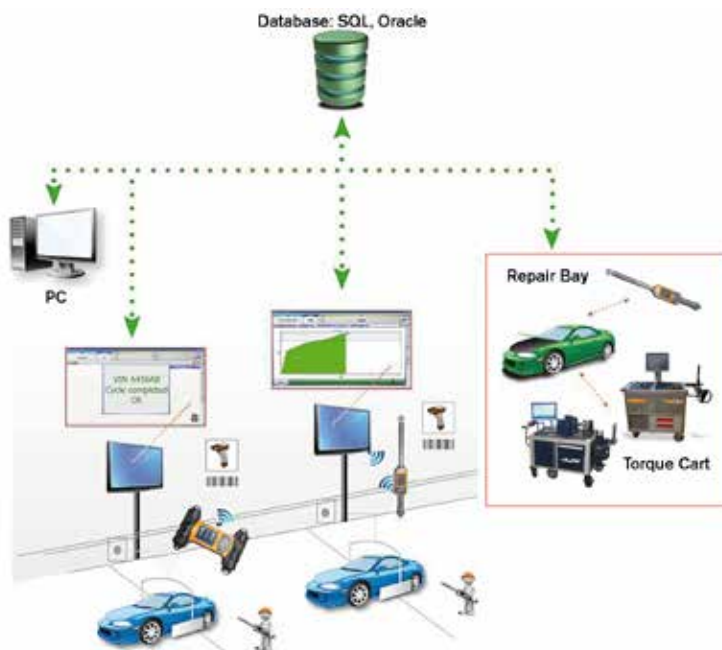

DATA COLLECTION SOFTWARE

FREEDOM3 EXPLORER SOFTWARE - QUALITY CONTROL

Freedom3 Explorer software enables collection of data, results, and curves from the ADET analyzer, the DataTouch3 analyzer, and the Freedom3 torque wrench. The software displays single or multi-curve graphs, and provides easy analysis of minimum/maximum torque, minimum/maximum angle, and final torque. Data can be exported to Excel.

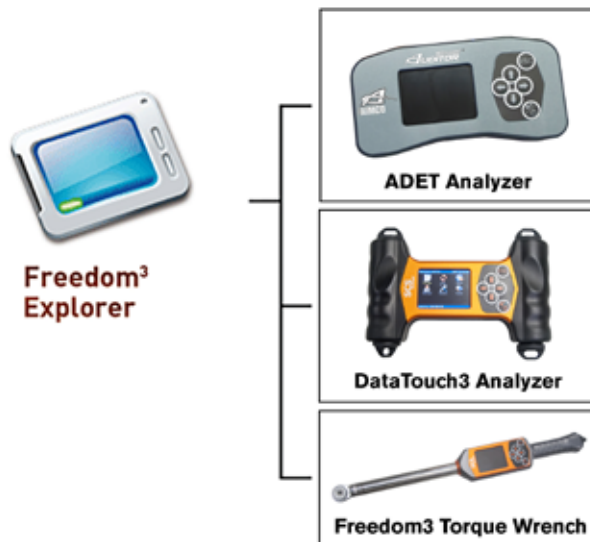
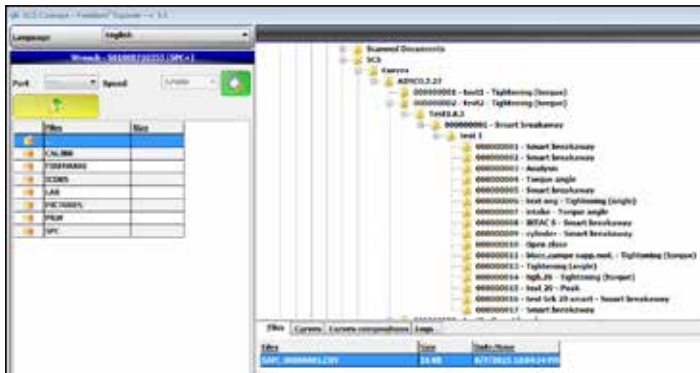

LAB results from wrench

VPG SOFTWARE - PRODUCTION LINE

VPG (Visual Production Guide) software works with Freedom3 torque wrench, and enables operators to configure assembly and rework processes.

From the computer, VPG sends tightening programs to Freedom3. Operators are driven through different tightening sequences. The software automatically selects the correct tightening program, and displays instructions accompanied by a picture of the operations, complete with status (to be tightened, OK and NOK). In rework mode, the user can manually select the sequences.

From the production line, Freedom3 sends real-time critical-joint fastening data after each tightening immediately to the PC. If the network is unavailable, the station will store the results until network connection is restored. VPG software allows full tractability including torque control, angle control, and yield control.

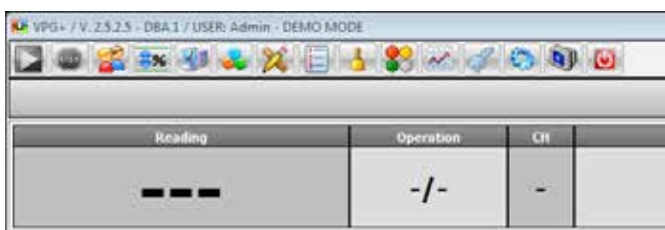

PRW real-time results from wrench to database - wireless

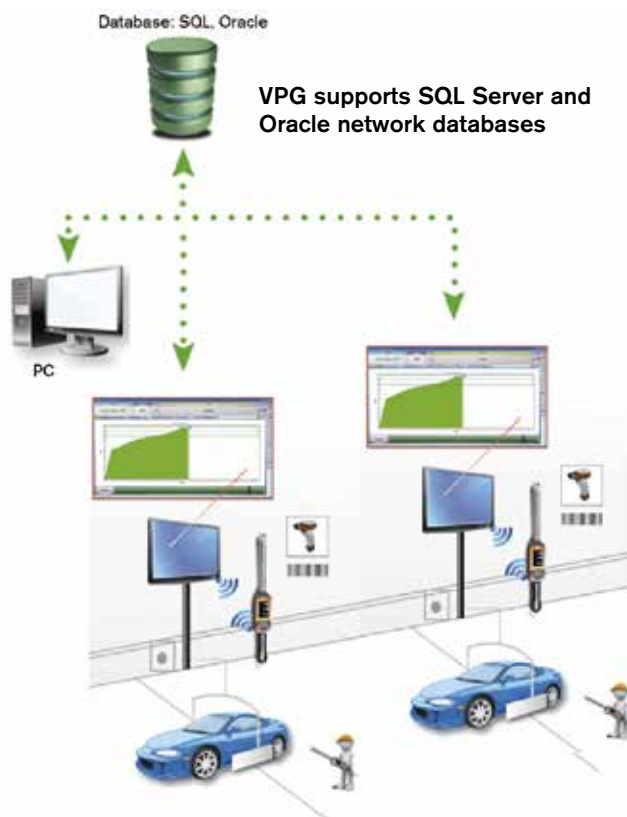

TRANSDUCERS

TORQUE MEASUREMENT: TRANSDUCERS

Features and Benefits

Superior:

- Accuracy
- Compatibility
- Durability

Auditor offers multiple styles of transducers in various configurations. Industry standard transducers (2mv/v) and intellect transducers for Auditor instruments that reduce configuration set up time.

Please contact our Customer Service Associates for additional information, 1-800-852-1368.

Used in Conjunction with Analyzers

	Stationary			Rotary		
	ASTIS	AISI - AISF	ASTB	ARTIS	ARTIS2	ARTB
ATC	X			X		
AUET	X			X		
AUET/MTM	X			X		
ATDA	X			X		
ATDA-8000		X				
ADET			X	X	X	X
DataTouch3			X	X	X	X

See Appendix A on page 70 to configure complete part.

AUDITOR™ STATIONARY TRANSDUCERS

Stationary Transducers with joint rundown fixtures and, where applicable, bench stands.



AISI

AISI/AISF Transducers connect to the ATDA-8000 analyzer and mount directly to a benchtop.

MODEL	MAX TORQUE		WEIGHT		W X H X D		DRIVE
	Nm	in-lb/ft-lb	kg	lb	mm	in	in
AISI-200025	2.8	25	1.13	2.5	79 x 95 x 83	3.13 x 3.75 x 3.25	1/4
AISI-200100	11.3	100	1.13	2.5	79 x 95 x 83	3.13 x 3.75 x 3.25	1/4
AISI-200500	56.5	500	1.13	2.5	79 x 95 x 83	3.13 x 3.75 x 3.25	3/8
AISF-200100	135.6	1,200/100	2.25	5	100 x 65	4 x 3	1/2
AISF-200250	339	3,000/250	2.25	5	100 x 65	4 x 3	1/2
AISF-201000	1350	12,000/1,000	2.8	6	100 x 65	4 x 3	1



ASTB

Can be connected to DataTouch or Auditor Torque Data Analyzers, or to a standard laptop via Bluetooth, allowing control of various types of power tools

MODEL	CAPACITY		DRIVE
	NM	FT-LB	IN
ASTB-25S-2C	2	1.5	1/4"
ASTB-75S-10C / ASTB-75R-10P	10	7	3/4" / SA 21
ASTB-75S-20C / ASTB-75R-20P	20	15	3/4" / SA 21
ASTB-75S-50C / ASTB-75R-50P	50	37	3/4" / SA 21
ASTB-75S-100C / ASTB-75R-100P	100	74	3/4" / SA 24
ASTB-75S-250C / ASTB-75R-250P	250	185	3/4" / SA 24
ASTB-75S-500C / ASTB-75R-500P	500	370	3/4" / SA 36
ASTB-100S-1000C / ASTB-1000R-1000P	1,000	740	1" / SA 46

R= ring nut drive, S= square drive

Call for quote on devices with larger capacities



ASTIS

ASTIS industry standard transducers can be used with multiple analyzers.

MODEL	MAX TORQUE		DRIVE
	Nm	in-lb/ft-lb	in
ASTIS-25D-11	11	100 in-lb	1/4
ASTIS-25D-28	28	250 in-lb	1/4
ASTIS-38D-135	135	100 ft-lb	3/8
ASTIS-50D-270	270	200 ft-lb	1/2
ASTIS-75D-1000	1017	750 ft-lb	3/4
ASTIS-100D-1700	1695 Nm	750 ft-lb	1

AUDITOR™ TRANSDUCERS

AUDITOR™ ROTARY TRANSDUCERS



ARTIS Series

Suitable for use with all continuous drive tools, impulse tools and torque wrenches.

MODEL	DRIVE	MAX TORQUE		LENGTH (A)	THICKNESS		WIDTH (C)	WEIGHT lb
		Nm	in-lb/ft-lb		(B)	(C)		
ARTIS-25H-2T(A)	1/4 Hex	2	18 in-lb	4.6	1.1	2.2	1.0	
ARTIS-25H-5T(A)	1/4 Hex	5	44 in-lb	4.6	1.1	2.2	1.0	
ARTIS-25H-20T(A)	1/4 Hex	20	180 in-lb	4.6	1.1	2.2	1.0	
ARTIS-25S-10T(A)	1/4 Sq.	10	88 in-lb	2.9	1.1	2.2	1.0	
ARTIS-38S-75T(A)	3/8 Sq.	75	50 ft-lb	3.0	1.6	2.7	1.2	
ARTIS-50S-180T(A)	1/2 Sq.	180	130 ft-lb	3.4	1.6	2.7	1.5	
ARTIS-75S-500T(A)	3/4 Sq.	500	370 ft-lb	4.1	2.0	3.1	2.2	
ARTIS-100S-1400T(A)	1 Sq.	1400	1025 ft-lb	4.9	2.4	3.6	4.0	

*Add "A" to the end of the part number to indicate torque/angle transducer.



ARTIS2-25S-10T

ARTIS2 Series

Can be connected to Auditor Torque Data Collector. Available with internal memory for automatic recognition when connected to Auditor Torque Data Collector.

MODEL	TORQUE		DRIVE IN
	NM	FT-LB	
ARTIS2-25H-2T	2	1.5	HEX 1/4"
ARTIS2-25H-5T	5	3.7	HEX 1/4"
ARTIS2-25S-10T	10	7	SQ. 1/4"
ARTIS2-25H-10T	10	7	HEX 1/4"
ARTIS2-25H-20T	20	15	HEX 1/4"
ARTIS2-25S-20T	20	15	SQ. 1/4"
ARTIS2-38S-25T	25	18	SQ. 3/8"
ARTIS2-38S-75T	75	55	SQ. 3/8"
ARTIS2-50S-180T	180	133	SQ. 1/2"
ARTIS2-75S-250T	250	184	SQ. 3/4"
ARTIS2-75S-500T	500	369	SQ. 3/4"
ARTIS2-75S-750T	750	553	SQ. 3/4"
ARTIS2-100S-1400T	1,400	1,033	SQ. 1"
ARTIS2-150S-3000T	3,000	2,213	SQ. 1 1/2"
ARTIS2-150S-5000T	5,000	3,688	SQ. 1 1/2"

Call for quote on devices with larger capacities

MODEL	TORQUE AND ANGLE		DRIVE IN
	NM	FT-LB	
ARTIS2-25H-2TA	2	1.5	HEX 1/4"
ARTIS2-25H-5TA	5	3.7	HEX 1/4"
ARTIS2-25S-10TA	10	7	SQ. 1/4"
ARTIS2-25H-10TA	10	7	HEX 1/4"
ARTIS2-25H-20TA	20	15	HEX 1/4"
ARTIS2-25S-20TA	20	15	SQ. 1/4"
ARTIS2-38S-25TA	25	18	SQ. 3/8"
ARTIS2-38S-75TA	75	55	SQ. 3/8"
ARTIS2-50S-180TA	180	133	SQ. 1/2"
ARTIS2-75S-250TA	250	184	SQ. 3/4"
ARTIS2-75S-500TA	500	369	SQ. 3/4"
ARTIS2-75S-750TA	750	553	SQ. 3/4"
ARTIS2-100S-1400TA	1,400	1,033	SQ. 1"
ARTIS2-150S-3000TA	3,000	2,213	SQ. 1 1/2"
ARTIS2-150S-5000TA	5,000	3,688	SQ. 1 1/2"

Call for quote on devices with larger capacities

ARTB WIRELESS TORQUE AND ANGLE ROTARY TRANSDUCERS







ARTB-25S-20TA

Can be connected to DataTouch or Auditor Torque Data Analyzers, or to a standard laptop via Bluetooth, allowing control of various types of power tools.

Model	Torque Range		Drive in
	Nm	ft-lb	
ARTB-25H-2T(TA)	0.2 - 2	0.2 - 1.5	HEX 1/4"
ARTB-25H-5T(TA)	0.5 - 5	0.4 - 3.7	HEX 1/4"
ARTB-25S-10T(TA)	1 - 10	0.7 - 7	1/4"
ARTB-25H-20T(TA)	2 - 20	1.5 - 15	HEX 1/4"
ARTB-25S-20T(TA)	2 - 20	1.5 - 15	1/4"
ARTB-38S-25T(TA)	2.5 - 25	2 - 19	3/8"
ARTB-38S-75T(TA)	7.5 - 75	6 - 56	3/8"
ARTB-50S-180T(TA)	18 - 180	13 - 133	1/2"
ARTB-75S-250T(TA)	25 - 250	19 - 185	3/4"
ARTB-75S-500T(TA)	50 - 500	37 - 370	3/4"
ARTB-100S-1400T(TA)	140 - 1,400	104 - 1,036	1"
ARTB-150S-3000T(TA)	300 - 3,000	222 - 2,220	1 1/2"
ARTB-150S-5000T(TA)	500 - 5,000	370 - 3,700	1 1/2"

Call for quote on devices with larger capacities

TORQUE MEASUREMENT RUNDOWN FIXTURES / JOINT SIMULATORS

RUNDOWN FIXTURE	MODEL SERIES	WEAR RESISTANT HEAVY DUTY	HEAVY DUTY FULLY ENCAPSULATED	HEAVY DUTY ENCAPSULATED WASHERS	STANDARD (INCLUDED W/ ANALYZER)	SPLINE DRIVE
	ARDIA-XXXHD	X				
	ARDFA-XXXHD	X				
	ARDFA-XXXHDS		X			
	ARDIA-XXXHDS		X			
	ARDFA-XXXHDE			X		
	ARDIA-XXXHDE			X		
	ARDFA-XXX				X	
	ARDIA-XXX				X	
	ARDA-XXX	X	X			X*

Fixtures can be ordered to simulate hard, med, or soft joints

Mechanical Belleville system of bolt, nut or nut body, Belleville washers and main housing, 1/4" - 3/4" drive sizes, 10 in/lbs - 1,200 ft/lbs

*Spline drive feature provides rundown control when testing pulse tools

JOINT SIMULATOR		
	AJKR-	Joint Kit for Rotary Transducer
	AJKS-	Joint Kit for Stationary Transducer

Provide linear response and are repeatable 1/4" - 1" drive sizes 28 - 1,695 Nm

HYDRAULIC MECHANICAL JOINT SIMULATOR	
	UFT SERIES

Accurate, repeatable, linear, and durable. Tests 3 - 690 Nm, M5 - M24 fastener sizes
See page 68.

Design Type:	Power Tools	Impulse Tools
Square drive	X	
Spline Drive		X

Rundown Fixtures used in conjunction with these external transducers:	ASTIS	AISI-AISF	ARTIS	ASTB	ARTB
ARDIA/ARDFA	X	X	X		X
ARDA				X	X
AJKS	X		X		
AJKR			X		X
UFT			X		X

TORQUE MEASUREMENT RUNDOWN FIXTURES / JOINT KITS



AUDITOR™ RUNDOWN FIXTURES

To test power tools, pneumatic or electric, consistent rotational speed must be achieved. The joint rundown fixture/simulator provides the means by which the tool motor and spindle rotates freely at the start of the test cycle and then develops torque as resistance to rotation increases as load on the fastener and joint increases. The linearity and consistency of the joint rundown fixtures/simulators vary greatly and the tool test data is a product of the variations in these rundown fixtures. Higher quality joint rundown fixtures produce torque data with less scatter.

Rundown fixtures for heavy duty use.

MODEL*	DESCRIPTION	RECOMMENDED TORQUE RANGE		SQUARE DRIVE
		IN-LB	Nm	
ARDIA-10(HD)(HDE)(HDS)	Rundown Fixture	1.0 - 10	.13 - 1.13	1/4
ARDIA-25(HD)(HDE)(HDS)	Rundown Fixture	2.5 - 25	.28 - 2.8	1/4
ARDIA-100(HD)(HDE)(HDS)	Rundown Fixture	10.0 - 100	1.3 - 11.3	1/4
ARDIA-250(HD)(HDE)(HDS)	Rundown Fixture	25.0 - 250	2.8 - 28.25	3/8
ARDIA-500(HD)(HDE)(HDS)	Rundown Fixture	50.0 - 500	5.6 - 56.5	3/8

* Add "HD" to part numbers for wear resistant models. Add "HDS" to part numbers for fully encapsulated wear resistant models.

* Add "HDE" to part numbers for partial encapsulated wear resistant models.

MODEL*	DESCRIPTION	RECOMMENDED TORQUE RANGE		SQUARE DRIVE
		IN-LB	Nm	
ARDFA-100(HD)(HDE)(HDS)	Rundown Fixture	10 - 100	13.6 - 136	1/2
ARDFA-150(HD)(HDE)(HDS)	Rundown Fixture	15 - 150	20.4 - 204	1/2
ARDFA-250(HD)(HDE)(HDS)	Rundown Fixture	25 - 250	34.0 - 340	1/2
ARDFA-600(HD)(HDE)(HDS)	Rundown Fixture	60 - 600	81.6 - 816	3/4

* Add "HD" to part numbers for wear resistant models. Add "HDS" to part numbers for encapsulated wear resistant models.

* Add "HDE" to part numbers for partial encapsulated wear resistant models.

JOINT KITS

	DRIVE SIZE - IN	ROTARY KIT PART NUMBER	STATIONARY KIT PART NUMBER
	1/4	AJKR-28	AJKS-25D
	3/8	AJKR-135	AJKS-38D
	1/2	AJKR-271	AJKS-50D
	3/4	AJKR-1017	AJKS-75D
	1	AJKR-1695	AJKS-100D

UFT SERIES JOINT SIMULATORS

UFT SERIES JOINT SIMULATORS

- AIMCO's UFT Joint Simulators offer the most repeatable and linear joint rate simulation of any product on the market.
- Pulse tool and continuous drive tool certification and testing.
- Consists of a bolt tightening body and a hydraulic pressure loading mechanism. A hydraulic pressure circuit connects these two bodies. Ideal for ISO 5393 test procedures.
- Three joint rates can be easily and quickly simulated by opening or closing two external valves.
- Specially coated testing bolt produces over 100,000 cycles without variation or deformation.



UFT-24



UFT-S10



UFT-S16

MODEL	BOLT SIZE	TORQUE RANGE		SNUG TORQUE NM	A-JOINT RATE NM/DEG	B-JOINT RATE NM/DEG	C-JOINT RATE NM/DEG	D-JOINT RATE NM/DEG	CENTER TO OUTSIDE X HEIGHT MM	WEIGHT	
		FT-LB	NM							LB	KG
UFT-S10	M6	5 - 11	6.7 - 14.7	2.7	0.36	0.10	0.04	0.02	76 x 203	43	19.5
	M8	11 - 23	14.7 - 31.4	7.5	0.79	0.26	0.06	0.03			
	M10	23 - 40	31.4 - 53.9	14.9	1.22	0.35	0.09	0.06			
UFT-S16	M12	40 - 65	53.9 - 88.2	27.5	1.80	0.51	0.22	0.09	97 x 256	88	40
	M14	65 - 110	88.2 - 149	44.0	2.70	0.79	0.22	0.14			
	M16	110 - 140	149 - 190	73.5	4.70	1.22	0.35	0.21			
UFT-24*	M18	140 - 217	190 - 294						138 x 171	108	49.1
	M20	217 - 325	294 - 441								
	M24	325 - 506	441 - 686								

* UFT-24 medium hard/soft joints only

Reaction fixture for continuous drive tools not included. Sockets included.

TORQUE MEASUREMENT CABLES

CABLES



ICBL-USB



ATDBLIS

TORQUE MEASUREMENT: CABLES								
MODEL	SERIAL CABLE	TRANSDUCER CABLE	ROTARY	ROTARY W/ANGLE	STATIONARY	IND STD	INTELLECT	
1	ICBL-USB	X						
2	ATDBLIS		X		X		X	
3	ATDBRIS		X	X		X	X	
4	ICBL-10P		X		X			X
5	ICBL-4P		X	X		X		X
6	ICBL-8000DIG		X					
7	RMC Cable DT.ET		X	X	X	X		
8	FWE Cable DT.ET		X					

Cables 1-5 are compatible with ATDA, AUET, ADW products

1. Connects between comport of display to PC
2. Connect to IS transducer w/ angle - 10 pin
3. Connect to IS transducer - 4 pin
4. Intellect transducer cable. Identification chip in cable - 10 pin connector
5. Intellect transducer cable. Identification chip in cable - 4 pin connector
6. Connect from ATDA-8000 series analyzer to AISI / AIFI transducer
7. Connect from DataTouch3 / ADET analyzer to ARTB/ARTS transducers
8. Connect from DataTouch3 / ADET analyzer to FWE Wrenches



CABLE COMPATIBILITY														
	ATC	AUET	AUET/MTM	AUET-DC	AUET/MTM-DC	ATDA	ATDA-DC	ATDA-8000	ATDA-8000-10-DCA(-TA)(-TP)	ADW	ADW-DC	FWE	AEDT	DataTouch
ICBL-USB	X	X	X	X	X	X	X			X	X			
ATDBLIS		X	X	X	X	X	X							
ATDBRIS		X	X	X	X	X	X							
ICBL-10P		X	X	X	X	X	X							
ICBL-4P		X	X	X	X	X	X							
ICBL-8000DIG								X	X					
RMC Cable DT.ET													X	X
FWE Cable DT.ET												X		

APPENDICES

APPENDIX A: TRANSDUCER CONFIGURATOR

Model Number	Base Model Number (1-11)					
	1	2	3	4	5	6
Examples of part numbers	A	I	S	I	-	2
	A	I	S	F	-	2
	A	X	R	N	-	1
Transducer Options and Configuration	Auditor	Configuration	Type	Units		Angle
		I = Intellect X = Industry Standard	R = Rotary S = Stationary W = Wireless	I = in lb F = ft lb N = NM		1 = Yes 2 = No

Base model number (first 11 characters) describes Auditor, Configuration Intellect or Industry Standard, Type Rotary, Stationary or Wireless, Engineering Units In Lb, Ft Lb or NM, Angle Yes or No and Capacity.

To complete configuration of a 15 character part number select options and configuration sequentially from column 1 through 15. Columns 7-11 specify torque capacity.

APPENDIX B: WRENCH CONFIGURATOR

Model Number Columns	Base Model Number (1-9)								
	1	2	3	4	5	6	7	8	9
Examples of part numbers	A	D	W	-	0	0	7	5	K
	A	D	W	-	0	0	1	0	K
	A	T	W	-	0	2	0	0	F
Wrench Options and Configuration	Auditor	Type	Wrench	Capacity					Style
		D = Digital T = Transducer							K = Katana D = Katana w/dovetail transducer F = "Stick" straight handle

Base model number (first 9 characters) describes Auditor, Type; Digital or Transducer, Capacity, Style; Katana, Katana w/Dovetail transducer or Stick.

To complete configuration of a 18 character part number select options and configuration sequentially from column 1 through 18. Columns 5-8 specify torque capacity.

APPENDICES

7	8	9	10	11	12	13	14	15
0	0	0	5	0	1	2	1	2
0	0	7	5	0	1	2	1	5
0	0	1	8	0	2	2	2	4
Capacity					Fixture	Expanded Range	Digital Transducer	Drive Size
					1 = Bench Stand 2 = Inline 3 = Loader	1 = Yes 2 = No	1 = Yes 2 = No	1 = 1/4" Hex 2 = 1/4" Sq 3 = 3/8" Sq 4 = 1/2" Sq 5 = 3/4" Sq 6 = 1" Sq 7 = 1-1/2" Sq

The base model number is not a complete part number, - Fixture, Expanded Range, Digital Transducer and Drive Size must be specified by building complete part number.

					Future Options (15-18)				
10	11	12	13	14	15	16	17	18	
1	1	3	3	1	2	2	2	2	
1	1	1	3	2	2	2	2	2	
2	2	3	1	2	2	2	2	2	
Data Collector	Bar Code Docking Station	Sq Dr	Configuration	Engineering Unit	Angle	Accelerometer	Graphics	Tone Generator	
1 = Yes 2 = No	1 = Yes 2 = No	1 = 1/4" 2 = 3/8" 3 = 1/2" 4 = 3/4" 5 = 1" 6 = NA	1 = Intellect (intelligent td) 2 = IS (industry standard) 3 = NA (digital wrench)	1 = NM 2 = ft lb 3 = in lb	1 = Yes 2 = No	1 = Yes 2 = No	1 = Yes 2 = No	1 = Yes 2 = No	
Not yet available so always enter 2 (No) for these options.									

The base model number is not a complete part number, - Data Collector, Bar Code & Docking Station, Sq Dr, Configuration, Engineering Unit and Future Options must be specified by completing 18 character part number.

APPENDICES

APPENDIX C: TEST STAND CONFIGURATOR

	Base Model Number (1-10)									
Model Number Columns	1	2	3	4	5	6	7	8	9	10
Example of part numbers	A	H	C	T	S	-	5	0	0	0
	A	H	C	T	S	-	5	0	0	0
	A	H	C	T	S	-	0	0	5	K
	A	H	B	T	S	-	2	0	0	0
Test Stand Configuration and options	Auditor	High	Cap	Test	Stand		Configuration & Capacity K= Hydraulic			

Base model number (first 10 characters) describes Auditor, High, Capacity or Brake, Test Stand, Torque Capacity and Configuration; Rotary or Hydraulic (K).

To complete configuration of a 18 character part number select options and configuration sequentially from column 1 through 18. Columns 7-10 specify torque capacity.

APPENDICES

	11	12	13	14	15	16	17	18
	1	3	3	5	7	1	1	2
	6	2	3	5	1	1	2	2
	1							
	4							
Display Options	Legs	Base Dimension	Rundown Fixture Options	Reaction Post Options	Casters	Arm for Display	Digital Module	
1 = ATDA	1 = 6" Legs	0 = 8" x 8"	1 = 500 ft lb capacity	1 = 6" Post	1 = Yes	1 = Yes	1 = Yes	
2 = No Embedded display	2 = No Legs	1 = 12' x 12"	2 = No rundown fixture	2 = No Post	2 = No	2 = No	2 = No	
3 = ATDA-DC	3 = 18" Legs	3 = 14" x 19"	3 = 1000 ft lb capacity	3 = 6" Posts				
4 = ATDA-8000 (7)	4 = Custom Legs in 6" increments	4 = 18" x 24"	4 = 2500 ft lb capacity	4 = Paddles				
5 = ATDA-8000-10 (10)		5 = 18" x 36"	5 = 5000 ft lb capacity	5 = Custom				
6 = Embedded Display		6 = NA no base plate	6 = 7500 ft lb capacity	6 = 9" Post				
7 = ATRC Module			7 = 1.5" rundown kit for "K" stands.	7 = 9" Posts				
			8 = 2.5" rundown kit for "K" stands.					

The base model number is not a complete part number, - Display Options, Legs, Base Dimension, Rundown Fixture, Reaction Post, Casters, Arm and Digital Module must be specified by building complete part number.

INDEX

MODEL #	PAGE	MODEL #	PAGE	MODEL #	PAGE	MODEL #	PAGE	MODEL #	PAGE
A									
AAP1B66400A	31	AEH33042C(-1,2)	18	AEP4A66625B	21	AES4A22025BVM	19	APTH-12OE11	55
AAP1B66600A	31	AEH33053C(-1,2)	18	AEP4A66925B	21	AES4A22030BVM	19	APTH-12OE12	55
AAP1B66850A	31	AEH33060C(-1,2)	18	AEP4A771200B	21	AES4A22040BVM	19	APTH-12OE13	55
AAP1B76950A	31	AEH33090C(-1,2)	18	AEP4A773000B	21	AES4A666250B	21	APTH-12OE14	55
AAP1B771800A	31	AEH33120C(-1,2)	18	AEP4A884200B	21	AES4A66425B	21	APTH-12OE15	55
AAP1B771350A	31	AEH33200C(-1,2)	18	AEP4A884200B1	21	AES4A66625B	21	APTH-12OE16	55
AAP1B772950A	31	AEH35140B(-1,2)	18	AEP4A885000B	21	AES4A66925B	21	APTH-12OE17	55
AAP1B885100A	31	AEH35175B(-1,2)	18	AEP4A896500B	21	AES4A771200B	21	APTH-12OE18	55
ADET	46	AEH4F12020B(-1,2)	18	AEP4A898100B	21	AES4A773000B	21	APTH-12OE19	55
ADETB	46	AEH4F12026B(-1,2)	18	AEP4(A)(B)66250BDL	23	AES4A884200B	21	APTH-12RT25	55
ADW-0010K	53	AEJ4A66250B	21	AEP4(A)(B)66425BDL	23	AES4A884200B1	21	APTH-12RT38	55
ADW-0075K	53	AEJ4A66425B	21	AEP4(A)(B)66625BDL	23	AES4A885000B	21	APTH-12RT50	55
ADW-0180K	53	AEJ4A66625B	21	AEP4(A)(B)66925BDL	23	AES4A896500B	21	APTH-12SD25	55
ADW-0270K	53	AEJ4A66925B	21	AEP4(A)(B)771200BDL	23	AES4A898100B	21	APTH-12SD38	55
ADW-0500K	53	AEJ4A771200B	21	AEP4(A)(B)773000BDL	23	AES4A884200B	21	APTH-12SD50	55
ADW-1400F	53	AEJ4A773000B	21	AEP4(A)(B)884200BDL	23	AES4(A)(B)66250BDL	23	APTH-14OE13	55
ADW-DS	53	AEJ4A884200B	21	AEP4(A)(B)884200BDL	23	AES4(A)(B)66425BDL	23	APTH-14OE14	55
AEC-CIM	28	AEJ4A884200B1	21	AEP4(A)(B)896500BDL	23	AES4(A)(B)66625BDL	23	APTH-14OE15	55
AED4A66250B	21	AEJ4A885000B	21	AEP4(A)(B)898100BDL	23	AES4(A)(B)66925BDL	23	APTH-14OE16	55
AED4A66425B	21	AEJ4A896500B	21	AEP4(A)(R)(T)12003B	10	AES4(A)(B)771200BDL	23	APTH-14OE17	55
AED4A66625B	21	AEJ4A898100B	21	(V)(Q)	10	AES4(A)(B)773000BDL	23	APTH-14OE18	55
AED4A66925B	21	AEJ4B66250B	21	AEP4(A)(R)(T)12006B	10	AES4(A)(B)884200BDL	23	APTH-14OE19	55
AED4A771200B	21	AEJ4B66425B	21	(V)(Q)	10	AES4(A)(B)885000BDL	23	APTH-14OE21	55
AED4A773000B	21	AEJ4B66625B	21	AEP4(A,R,T)12011BR	20	AES4(A)(B)896500BDL	23	APTH-14OE22	55
AED4A884200B	21	AEJ4B66925B	21	AEP4(A)(R)(T)12011B	20	AES4(A)(B)898100BDL	23	APTH-14OE24	55
AED4A884200B1	21	AEJ4B771200B	21	(V)(Q)	10	AET32020C(DL)	17	APTH-14OE27	55
AED4A885000B	21	AEJ4B773000B	21	AEP4(A,R,T)12014BR	20	AET32025C(DL)	17	APTH-14OE30	55
AED4A896500B	21	AEJ4B884200B	21	AEP4(A)(R,T)12014B	20	AET32035C(DL)	17	APTH-14OE32	55
AED4A898100B	21	AEJ4B884200B1	21	(V)(Q)	10	AET32050C(DL)	17	APTH-14OE34	55
AED4A896500B	21	AEJ4B885000B	21	AEP4(A,R,T)12018BR	20	AET4A12025B-KD	17	APTH-14OE36	55
AED4A898100B	21	AEJ4B896500B	21	AEP4(A)(R)(T)12018B(V)	10	AET4AA12018B	17	APTH-14OE38	55
AEF35075A(V)(VB)	16	AEJ4B898100B	21	AEP4(A,R,T)12022BR	20	AET4AB12025B	17	APTH-14OE41	55
(-2)(B-2)	16	AEL4A12003B(Q)	8	AEP4(A)(R)(T)12022B(V)	10	AFRL-2	33	APTH-14RT34	55
AEF35090A(V)(VB)	16	AEL4A12006B(Q)	8	AEP4(A,R,T)22020BR	20	AFRL-2-C	33	APTH-14RT50	55
(-2)(B-2)	16	AEL4A12011B(Q)	8	AEP4(A)(R)(T)22020B(V)	10	AFRL-3	33	APTH-14SD50	55
AEF35110A(V)(VB)	16	AEL4A12014B(Q)	8	AEP4(A,R,T)22025BR	20	AFRL-3-C	33	APTW-25	55
(-2)(B-2)	16	AEL4A12018B(Q)	8	AEP4(A)(R)(T)22025B(V)	10	AFRL-4	33	APTW-50	55
AEF35135A(V)(VB)	16	AEL4A12022B	8	AEP4(A,R,T)22030BR	20	AFRL-8	33	APTW-100	55
(-2)(B-2)	16	AEN32015C(F)(DL)	12	AEP4(A)(R)(T)22030B(V)	10	AHBT5-2500	51	APTW-150	55
AEF35170A(V)(VB)	16	AEN32025C(F)(DL)	12	AEP4(A)(R)(T)22035B(V)	10	AHBT5-5000	51	APTW-200	55
(-2)(B-2)	16	AEN32030C(F)(DL)	12	AEP4(A,R,T)22040BR	20	AHCTS-0.5K	50	APTW-340	55
AEF35280A(V)(VB)	16	AEN32040C(F)(DL)	12	AEP4(A)(R)(T)22040B(V)	10	AHCTS-1.5RDF	49	ARDA-XXX	66
(-2)(B-2)	16	AEN33042C(F)	12	AEP4B66250B	21	AHCTS-001K	50	ARDA-100(HD)(HDE)	67
AEF35350A(V)(VB)	16	AEN33053C(F)	12	AEP4B66425B	21	AHCTS-1RDF	49	(HDS)	67
(-2)(B-2)	16	AEN33060C(F)(DL)	12	AEP4B66625B	21	AHCTS-2.5K	50	ARDA-150(HD)(HDE)	67
AEF35420A(V)(VB)	16	AEN33090C(F)(DL)	12	AEP4B66925B	21	AHCTS-3/4RDF	49	(HDS)	67
(-2)(B-2)	16	AEN33120C(F)(DL)	12	AEP4B771200B	21	AHCTS-005K	50	ARDA-250(HD)(HDE)	67
AEF35515A(V)(VB)	16	AEN33200C(F)(DL)	12	AEP4B773000B	21	AHCTS-010K	50	(HDS)	67
(-2)(B-2)	16	AEN33210C(F)(DL)	12	AEP4B884200B	21	AHCTS-025K	50	ARDA-600(HD)(HDE)	67
AEF35635A(V)(VB)	16	AEN33300C(F)(DL)	12	AEP4B884200B1	21	AHCTS-0500	50	(HDS)	67
(-2)(B-2)	16	AEN33375C(F)(DL)	12	AEP4B885000B	21	AHCTS-2500	50	ARDA-XXX	66
AEF4A66250B	21	AEN335090B(F)	13	AEP4B896500B	21	AHCTS-7500	50	ARDA-XXXHDE	66
AEF4A66425B	21	AEN35140B(F)	13	AEP4B898100B	21	AHCTS-5025	50	ARDA-XXXHDS	66
AEF4A66625B	21	AEN35175B(F)	13	AEP(A)(B)773000BDL	23	AIMTS-0500	51	ARDA-XXXXHD	66
AEF4A66925B	21	AEN35225B(F)	13	AES32010C(V)(Q)	14	AIMTS-2000	51	ARDIA-10(HD)(HDE)	67
AEF4A771200B	21	AEN35285B(F)	13	AES32020C(V)(Q)	14	AISF-200100	64	(HDS)	67
AEF4A773000B	21	AEN35350B(F)	13	AES32025C(V)(Q)	14	AISF-200250	64	ARDIA-25(HD)(HDE)	67
AEF4A884200B	21	AEN356540A	22	AES32038C(V)	14	AISF-201000	64	(HDS)	67
AEF4A884200B1	21	AEN357100A	22	AES33040C(V)(-2)	14	AISI-200025	64	ARDIA-100(HD)(HDE)	67
AEF4A885000B	21	AEN3571600A	22	AES33060C(V)(-2)	14	AISI-200100	64	(HDS)	67
AEF4A896500B	21	AEN3572600A	22	AES33100C(V)(-2)	14	AISI-200500	64	ARDIA-250(HD)(HDE)	67
AEF4A898100B	21	AEN4C12004B	8	AES33150C(V)(-2)	14	AJKR	66	(HDS)	67
AEF4(A)(B)66250BDL	23	AEN4C12009B	8	AES33230C(V)(-2)	14	AJKR-28	67	ARDIA-500(HD)(HDE)	67
AEF4(A)(B)66425BDL	23	AEN4C12014B	8	AES33400C	14	AJKR-135	67	(HDS)	67
AEF4(A)(B)66625BDL	23	AEN4C12018B	8	AES33600C	14	AJKR-271	67	ARDIA-XXX	66
AEF4(A)(B)66925BDL	23	AEN4C12022B	8	AES35075AV	15	AJKR-1017	67	ARDIA-XXXHD	66
AEF4(A)(B)771200BDL	23	AEN4C22015BM(F)	19	AES35090AV	15	AJKR-1695	67	ARDIA-XXXHDE	66
AEF4(A)(B)773000BDL	23	AEN4F22030BM(F)	19	AES35110AV	15	AJKS	66	ARDIA-XXXHDS	66
AEF4(A)(B)884200BDL	23	AEN4F22037BM(F)	19	AES35135AV	15	AJKS-25D	67	ARTB-25H-2T(TA)	65
AEF4(A)(B)884200BDL	23	AEN4F22044BM(F)	19	AES35170AV	15	AJKS-38D	67	ARTB-25H-5T(TA)	65
AEF4(A)(B)885000BDL	23	AEP35075AV(T)	11	AES35280A	15	AJKS-50D	67	ARTB-25H-20T(TA)	65
AEF4(A)(B)896500BDL	23	AEP35090AV(T)	11	AES35350A	15	AJKS-75D	67	ARTB-25S-10T(TA)	65
AEF4(A)(B)898100BDL	23	AEP35110AV(T)	11	AES35420A	15	AJKS-100D	67	ARTB-25S-20T(TA)	65
AEF4(A)(C)(X)12003B(B)	8	AEP35135AV	11	AES35515A	15	AMPST-2-I	29	ARTB-38S-25T(TA)	65
AEF4(A)(C)(X)12006B(B)	8	AEP35170AV(T)	11	AES35635A	15	AMPST-4-I	29	ARTB-38S-75T(TA)	65
AEF4(A)(C)(X)12011B(B)	8	AEP35280A(T)	11	AES4A12003B(V)(Q)	8	AMPST-6-I	29	ARTB-50S-180T(TA)	65
AEF4(A)(C)(X)12014B(B)	8	AEP35350A(T)	11	AES4A12006B(V)(Q)	8	AMPST-6S-I	29	ARTB-75S-250T(TA)	65
AEF4(A)(C)(X)12018B(B)	8	AEP35420A(T)	11	AES4A12011B(V)(Q)	8	AMPST-8-I	29	ARTB-75S-500T(TA)	65
AEF4(A)(C)(X)12022B(B)	8	AEP35515A(T)	11	AES4A12014B(V)(Q)	8	APTH-12OE7	55	ARTB-100S-1400T(TA)	65
AEH32025C(-1,2)	18	AEP35635A(T)	11	AES4A12018B(V)	8	APTH-12OE8	55	ARTB-150S-3000T(TA)	65
AEH32030C(-1,2)	18	AEP4A66250B	21	AES4A12022B(V)	8	APTH-12OE9	55	ARTB-150S-5000T(TA)	65
AEH32040C(-1,2)	18	AEP4A66425B	21	AES4A22020BVM	19	APTH-12OE10	55	ARTIS-25H-2T(A)	65

INDEX

MODEL #	PAGE	MODEL #	PAGE	MODEL #	PAGE	MODEL #	PAGE	MODEL #	PAGE	
ARTIS-25H-5T(A)	65	AUET-0100(-DC)	41	iEC4EP	5	26709	28			
ARTIS-25H-20T(A)	65	AUET-250(-DC)	41	iEC4EVD	5	26800	24			
ARTIS-25S-10T(A)	65	AUET-500(-DC)	41	iEC4EVP(T)	5	26810	24			
ARTIS-38S-75T(A)	65	AUET-1000(-DC)	41	iEC4EV(T)	5	26815	24			
ARTIS-50S-180T(A)	65	AUET-1200(-DC)	41	iTVC	60	26820	24			
ARTIS-75S-500T(A)	65	AUET/MTM-10-100		L						
ARTIS-100S-1400T(A)	65	(-DC)	41	LS4208	30	26830	24			
ARTIS2-25H-2T	65	AUET/MTM-50-250		LS4278	30	26840	24			
ARTIS2-25H-2TA	65	(-DC)	41	M, N, O, P, Q						
ARTIS2-25H-5T	65	AUET/MTM-50-500		MSB	61	26934	28			
ARTIS2-25H-5TA	65	(-DC)	41	R						
ARTIS2-25H-10T	65	AUET/MTM-100-500		RMC Cable DT.ET	69	27045	24			
ARTIS2-25H-10TA	65	(-DC)	41	S						
ARTIS2-25H-20T	65	AUET/MTM-100-1000		SQNET	62	27110	28			
ARTIS2-25H-20TA	65	(-DC)	41	T						
ARTIS2-25S-10T	65	B			Tool Manager	48	27115	28		
ARTIS2-25S-10TA	65	BJ10051	30	U						
ARTIS2-25S-20T	65	BJ10052	30	UFT-24	68	27122	28			
ARTIS2-25S-20TA	65	BJ10053	30	UFT-S10	68	27200	24			
ARTIS2-38S-25T	65	BJ10054	30	UFT-S16	68	27210	28			
ARTIS2-38S-25TA	65	BJ10055	30	V, W, X, Y, Z						
ARTIS2-38S-75T	65	BJ10076	32	VPG	63	27255	24			
ARTIS2-38S-75TA	65	BJ10077	32	Numerical						
ARTIS2-50S-180T	65	BJ10078	32	20322	30	27370	28			
ARTIS2-50S-180TA	65	C			20403	28	27594	29		
ARTIS2-75S-250T	65	CA150108DHD	49	20712	29	27768	32			
ARTIS2-75S-500T	65	CA1510	49	20848	29	27769	32			
ARTIS2-75S-500TA	65	CA1550	49	20853	30	27771	32			
ARTIS2-75S-750T	65	CA1575	49	21159	29	27791	29			
ARTIS2-100S-1400T	65	CA25101	49	21208	29	27816	30			
ARTIS2-100S-1400TA	65	CA25151	49	21226	29	28161	32			
ARTIS2-150S-3000T	65	CA25751	49	23490	28	28162	32			
ARTIS2-150S-3000TA	65	D, E			23575	29	28163	32		
ARTIS2-150S-5000T	65	DATAPRO	62	23662	29	28164	32			
ARTIS2-150S-5000TA	65	DataTouch3	47	23730	30	28489	30			
ASH-500C-15MSZ	32	F, G, H			24320	28	28514	24		
ASH-500C-25MSZ	32	FRDM3-15	57	24330	28	28549	24			
ASH-500Z	32	FRDM3-30	57	24924	30	500-RZ	32			
ASTB-25S-2C	64	FRDM3-70	57	25265	30	500-SZ	32			
ASTB-75R-10P	64	FRDM3-100	57	25274	24					
ASTB-75R-20P	64	FRDM3-200	57	25275	24					
ASTB-75R-50P	64	FRDM3-300	57	25276	24					
ASTB-75R-100P	64	FRDM3-400	57	25277	24					
ASTB-75R-250P	64	FRDM3-600	57	25278	24					
ASTB-75R-500P	64	FRDM3-800	57	25287	24					
ASTB-75S-10C	64	FRDM3-1000	57	25289	24					
ASTB-75S-20C	64	FRDM3-1200	57	25291	24					
ASTB-75S-50C	64	FREEDOM3 EXPLORER	63	25350	28					
ASTB-75S-100C	64	Freedom FWE(TA) 15	59	25491	28					
ASTB-75S-200C	64	Freedom FWE(TA) 30	59	25501	29					
ASTB-75S-500C	64	Freedom FWE(TA) 70	59	25518	28					
ASTB-75S-1000C	64	Freedom FWE(TA) 100	59	25646	28					
ASTB-75S-250C	64	Freedom FWE(TA) 200	59	25717	30					
ASTB-75S-500C	64	Freedom FWE(TA) 300	59	25718	30					
ASTB-75S-1000C	64	Freedom FWE(TA) 400	59	25843	30					
ASTB-1000R-1000P	64	Freedom FWE(TA) 600	59	26327	24					
ASTIS-25D-11	64	Freedom FWE(TA) 800	59	26328	24					
ASTIS-25D-28	64	Freedom FWE(TA) 1000	59	26332	24					
ASTIS-38D-135	64	Freedom FWE(TA) 1200	59	26336	24					
ASTIS-50D-270	64	FTY	61	26337	24					
ASTIS-75D-1000	64	FWE Cable DT.ET	69	26364	28					
ASTIS-100D-1700	64	I, J, K			26443	30				
ATC-10	40	ICBL-4P	69	26477	24					
ATC-25	40	ICBL-10P	69	26478	24					
ATC-100	40	ICBL-8000DIG	69	26479	24					
ATC-250	40	ICBL-USB	69	26568	29					
ATC-250F	40	iEC4E	5	26570	30					
ATC-500	40	iEC4ED	5	26594	28					
ATC-750F	40	iEC4EGD	5	26700	28					
ATDA	44	iEC4EGP	5							
ATDA-8000	45	iEC4EG(T)	5							
ATDA-8000-10-DCA(-TA)		iEC4EGVD	5							
(-TP)	45	iEC4EGVP	5							
ATDA-DC	44	iEC4EGV(T)	5							
ATDBLIS	69									
ATDBRIS	69									
ATW-0100F	54									
ATW-0200F	54									
ATW-0500F	54									
ATW-1000F	54									
Audit Manager	48									
AUET-10(-DC)	41									
AUET-50(-DC)	41									



Visit our *NEW* website
WWW.AIMCO-GLOBAL.COM

AIMCO CORPORATE HEADQUARTERS

10000 SE Pine Street
Portland, Oregon 97216
Phone: (503) 254-6600
Toll Free: 1-800-852-1368

AIMCO CORPORATION DE MEXICO SA DE CV

Ave. Cristobal Colon 14529
Chihuahua, Chihuahua. 31125
Mexico
Phone: (01-614) 380-1010
Fax: (01-614) 380-1019

AIMCO EUROPE

C/ Río Gallo, 431 urb. Montelar
19174 Galápagos / Guadalajara
Spain
Phone: +34 673 34 99 25

AIMCO CHINA

Room 607, No. 3998 Hongxin Rd
Minhang District, Shanghai
China
Phone: 0086-21-34319246
Fax: 0086-21-34319245

AIMCO SOUTH AMERICA

Carrera 29A, #7B-91. Origami Building. Int604
Medellin; Colombia 050021

HIGH CAPABILITY
The Most Advanced Collection of