

Signature Series SPT-P825 CORDLESS TRANSDUCERIZED TOOL

EXPLODED VIEW

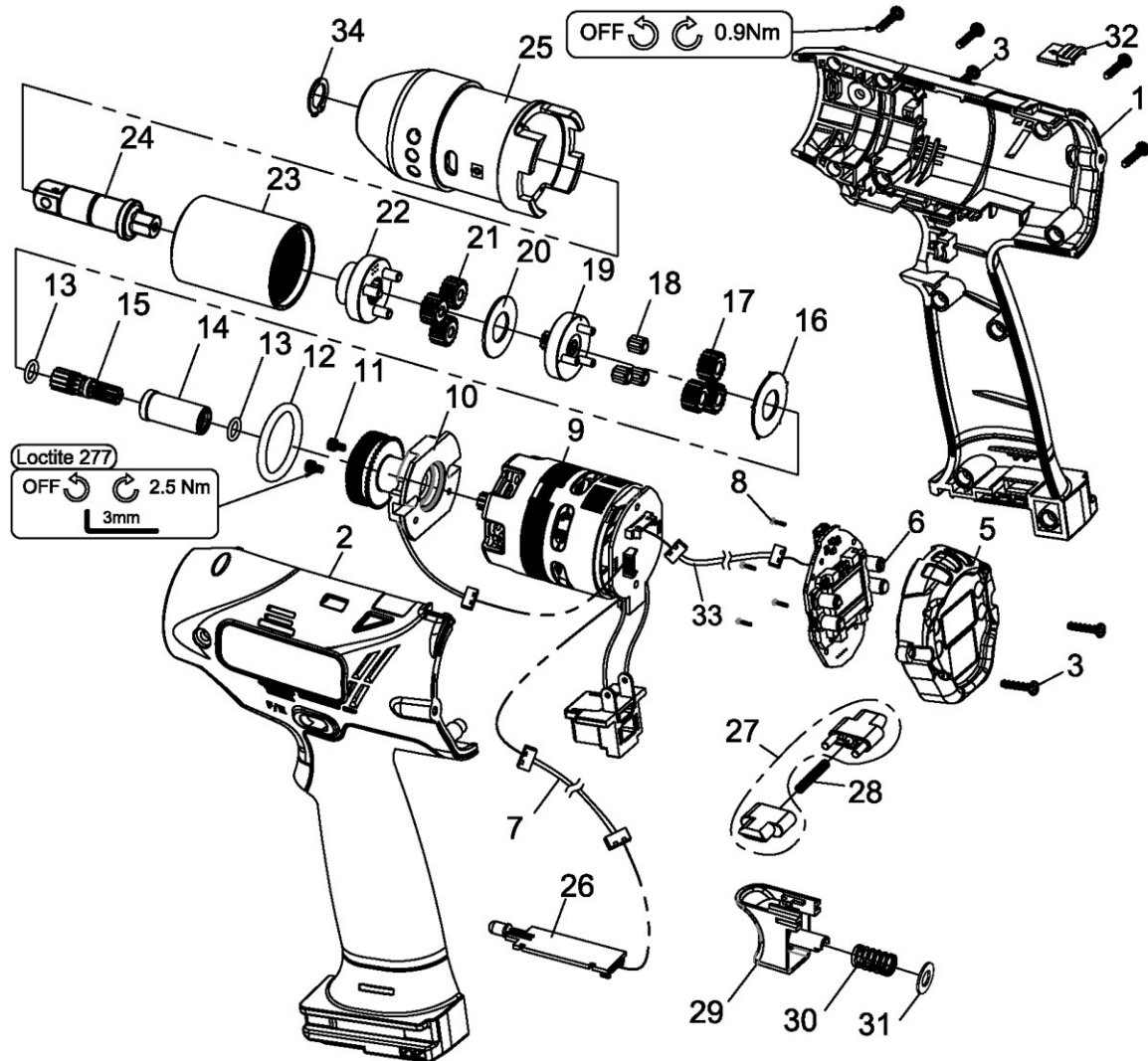

PARTS LIST — FOR REFERENCE ONLY

Index Number	Part Number	Description	Qty.	Index Number	Part Number	Description	Qty.	Index Number	Part Number	Description	Qty.
1	33101-NPA	Upper Housing	1	14	33242-NRA-01	Sleeve Coupling	1	26	32076-NPA-02	PC Board	1
2	33102-NPA	Lower Housing	1	15	33249-NPA-09	Sun Gear	1	27	B091WT#B1	F/R Valve (1 set x 2 pcs)	1
3	000-0930	Screw (3 x 14L)	12	16	D39SC180B-4	Washer	1	28	D48IWT	Spring	1
5	33110-NPA-01	Cover	1	17	33249-NPA-11	Planet Gear	3	29	32009-NPA-01	Trigger Assembly	1
6	32076-NPA-03	LCM Board Assembly	1	18	000-2415	Needle Bearing (INA-K357)	3	30	D48PW15	Spring	1
7	B86IWT	Connector Wire	1	19	32051-NPA-03	Gear Cage Assembly	1	31	C39PW15-3	Washer	1
8	0-151018	Screw (2.6 x 6L)	4	20	D39SC108B	Washer	1	32	33110-NPA-02	Cover	1
9	32083-NPA-01	Brushless Motor w/driver	1	21	33249-NPA-06	Planet Gear	3	33	B86PW35	Connector Wire	1
10	32046-NPA-02	Transducer Assembly	1	22	32051-NPA-04	Gear Plate Assembly	1	34	000-3011	Snap Ring (STW-11)	1
11	0-101066	Screw (M4 x 11L)	2	23	32049-NPA-01	Gear Ring Assembly	1				
12	0-431022	O-Ring (P26)	1	24	32043-NPA-02	Shaft Assembly	1				
13	00-41255	O-Ring (S7)	2	25	32041-NPA-01	Front Cover Assembly	1				

FOOTNOTES



10000 SE PINE
 PORTLAND, OR 97216
 503-254-6600
 FAX 503-255-2615

When ordering spare parts, please specify tool type, part number, and description.