

Signature Series SPT-P1625Q CORDLESS TRANSDUCERIZED TOOL

EXPLODED VIEW

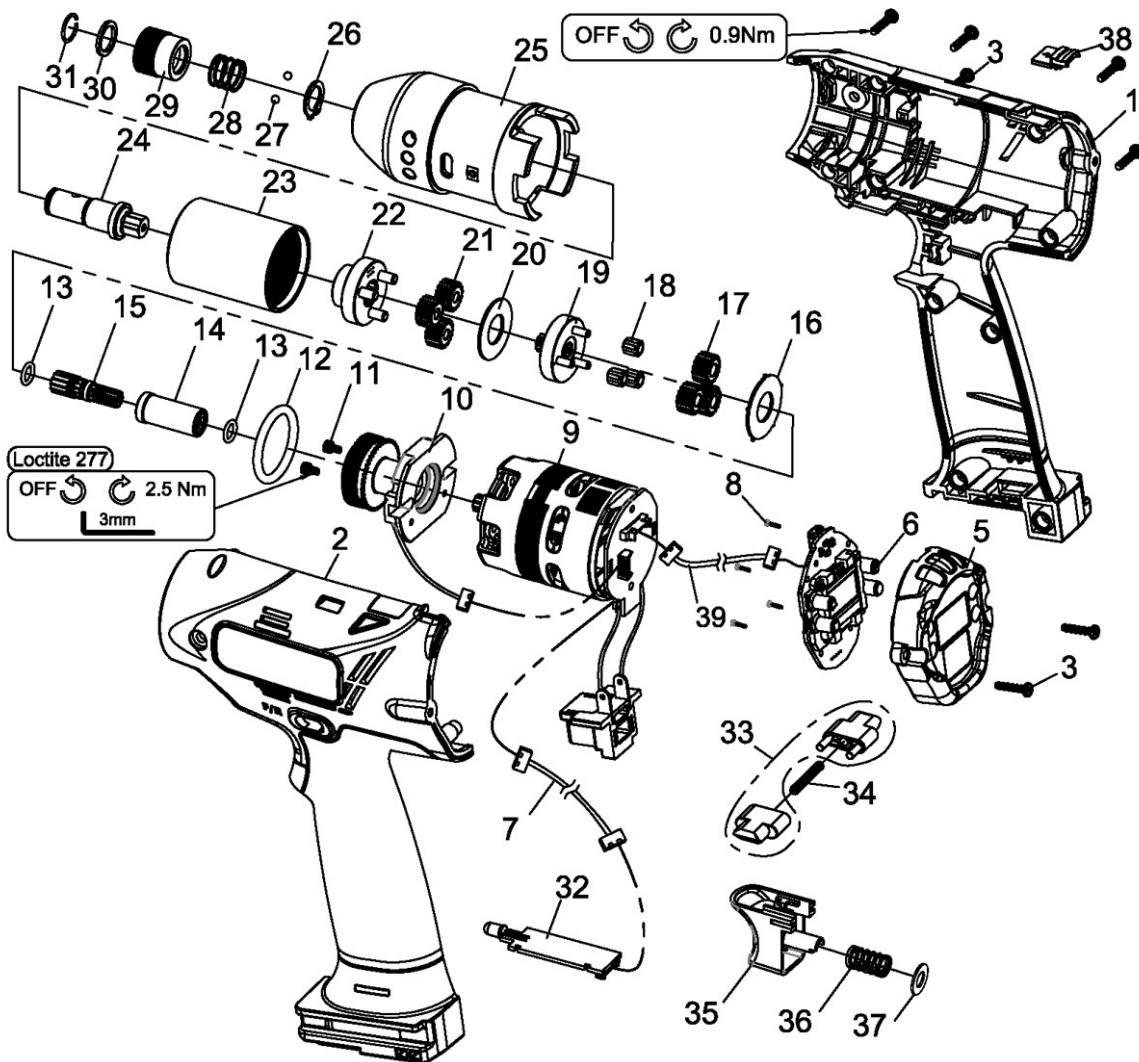

PARTS LIST — FOR REFERENCE ONLY

Index Number	Part Number	Description	Qty.	Index Number	Part Number	Description	Qty.	Index Number	Part Number	Description	Qty.
1	33101-NPA	Upper Housing	1	15	33249-NPA-15	Sun Gear	1	28	D42ID144A	Quick Change Holder	1
2	33102-NPA	Lower Housing	1	16	D39SC180B-4	Washer	1	29	D48ID144A	Spring	1
3	000-0930	Screw (3 x 14L)	12	17	33249-NPA-17	Planet Gear	3	30	D39ID144A	Hold Spacer	1
5	33110-NPA-01	Cover	1	18	000-2415	Needle Bearing (INA-K357)	3	31	D44ID144A	Anvil Collar	1
6	32076-NPA-03	LCM Board Assembly	1	19	32051-NPA-05	Gear Cage Assembly	1	32	32076-NPA-02	PC Board	1
7	B86IWT	Connector Wire	1	20	D39SC108B	Washer	1	33	B09IWT#B1	F/R Valve (1 set x 2 pcs)	1
8	0-151018	Screw (2.6 x 6L)	4	21	33249-NPA-07	Planet Gear	3	34	D48IWT	Spring	1
9	32083-NPA-03	Brushless Motor w/driver	1	22	32051-NPA-02	Gear Plate Assembly	1	35	32009-NPA-01	Trigger Assembly	1
10	32046-NPA-03	Transducer Assembly	1	23	32049-NPA-01	Gear Ring Assembly	1	36	D48PW15	Spring	1
11	0-101066	Screw (M4 x 11L)	2	24	33243-NPA-01	Shaft	1	37	C39PW15-3	Washer	1
12	0-431022	O-Ring (P26)	1	25	32041-NPA-01	Front Cover Assembly	1	38	33110-NPA-02	Cover	1
13	00-41255	O-Ring (S7)	2	26	000-3011	Snap Ring (STW-11)	1	39	B86PW35	Connector Wire	1
14	33242-NRA-01	Sleeve Coupling	1	27	000-3833	Steel Ball (3)	2				

FOOTNOTES



10000 SE PINE
 PORTLAND, OR 97216
 503-254-6600
 FAX 503-255-2615

When ordering spare parts, please specify tool type, part number, and description.