

EXPLODED VIEW

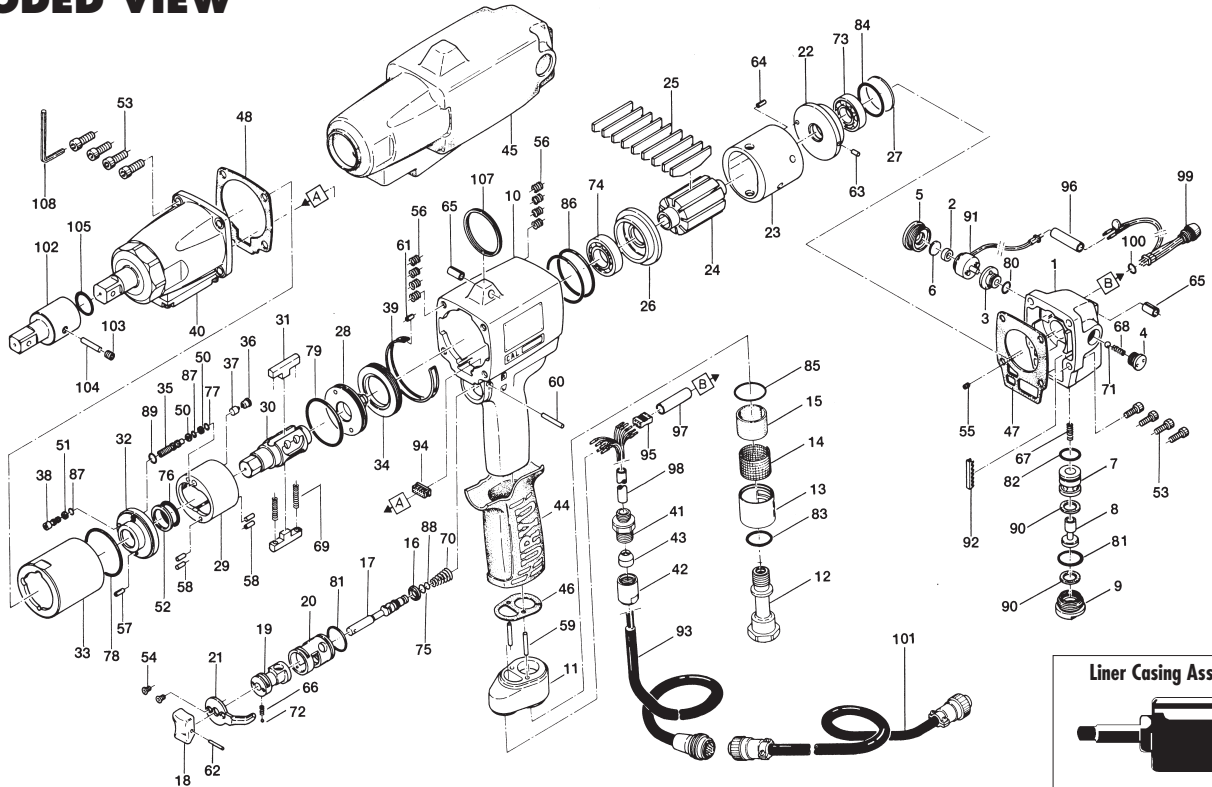

PARTS LIST — FOR REFERENCE ONLY

Index Number	Part Number	Description	Qty.	Index Number	Part Number	Description	Qty.	Index Number	Part Number	Description	Qty.
1	149-012-6	Head Cover	1	40	851-682-1	Sensor Casing Assembly (S12 - 12.7)	1	76	992-021-0	O-Ring (Q16-NTN)	1 ●
2	193-120-6	Valve Packing Spacer	1	41	149-079-2	Connector	1	77	990-320-0	O-Ring (ART-568-003)	1 ●
3	193-147-6	Stop Valve Bushing	1	42	149-018-2	Cap	1	78	990-338-0	O-Ring (JW1530-28)	1
4	193-148-6	Stop Valve Cover	1	43	149-562-2	Stopper	1	79	990-607-0	O-Ring (34 x 2.3)	1 ●
5	193-149-6	Stop Valve Plug	1	44	173-842-0	Handle Cover	1	80	990-905-0	O-Ring (SNS-7)	1
6	193-872-6	Valve Packing	1	45	149-840-6	Handle Protector	1	81	990-914-0	O-Ring (SNS-16)	2
7	149-253-6	Shut-Off Valve Bushing	1	46	149-850-5	Casing Connector Packing	1	82	990-910-0	O-Ring (SNS-12.5)	1
8	149-254-5	Shut-Off Valve	1	47	149-853-6	Head Cover Packing	1	83	990-916-0	O-Ring (SNS-18)	1
9	149-927-5	Shut-Off Valve Cover	1	48	149-867-6	Front Casing Packing	1	84	990-920-0	O-Ring (SNS-25)	1
10	149-025-6	Casing	1	50	944-002-0	Supporting Ring (2.6 x 4.5 x 1)	2 ●	85	990-921-0	O-Ring (SNS-22.4)	1
11	149-035-5	Casing Connector	1	51	944-003-0	Supporting Ring (3 x 5 x 1)	1 ●	86	990-938-0	O-Ring (SNS-48)	2
12	148-091-9	Air Inlet Bushing	1	52	944-210-0	Supporting Ring (16 x 19.9 x 1)	1 ●	87	990-900-0	O-Ring (SNS-2)(NOK)	2 ●
13	173-780-5	Exhaust Stack	1	53	945-117-0	Allen Head Bolt (M5 x 16)	8	88	990-972-0	O-Ring (SNS-4)(NOK)	1
14	173-042-0	Silencer	1	54	948-423-0	Allen Flush Head Screw (M3 x 6)	2	89	990-973-0	O-Ring (SNS-5)(NOK)	1 ●
15	173-835-0	Filter	1	55	954-005-0	Allen Head Dog Point Screw (M3 x 5)	1	90	996-418-0	Packing (15 x 9 x 1)	2
16	173-100-0	Valve	1	56	965-011-0	Heli-Sert (M5 x 1.5D)	8	91	909-915-0	Solenoid Valve Assembly	1
17	173-104-0	Valve Rod	1	57	969-450-0	Pin (G) (3 x 8)	1	92	909-486-0	Free Bushing (KG-024)	1
18	149-107-2	Valve Lever	1	58	970-206-0	Pin (H) (3 x 8)	4	93	910-250-0	Joint Cable Assembly (RED)	1
19	151-210-4	Reverse Valve	1	59	970-208-0	Pin (H) (3 x 10)	2	94	909-918-0	Double-Row Socket (DF11-12DC-2C)	1
20	151-211-4	Reverse Valve Bushing	1	60	971-125-0	Pin (2 x 25)	1	95	909-733-0	Connector (RF-06)	1
21	173-212-0	Reverse Lever	1	61	973-007-0	Roll Pin (2 x 7)	1	96	909-707-0	Shrink Tube (6 x 30)	1
22	149-285-6	Rear Plate	1	62	973-014-0	Roll Pin (2 x 14)	1	97	909-708-0	Shrink Tube (8 x 30)	1
23	173-286-0	Cylinder	1	63	973-066-0	Roll Pin (2.5 x 6)	1	98	909-738-0	Shrink Tube (6 x 40)	1
24	173-287-0	Rotor	1	64	973-068-0	Roll Pin (2.5 x 8)	1	99	909-549-0	LED Lamp Assembly	1
25	151-288-9	Blade (PC)	9	65	973-340-0	Roll Pin (6 x 10)	2	99-1	975-079-0	Spacer (12.7 x 10.3 x 3)	1
26	173-289-0	Front Plate	1	66	976-006-0	Spring (3 x 5 x 0.4)	1	100	990-907-0	O-Ring (SNS-9)	1
27	193-291-7	Rear Plate Spacer	1	67	976-224-0	Spring (4.5 x 18 x 0.45)	1	ACCESSORIES			
28	194-901-3	Rear Liner Plate	1	68	976-240-0	Spring (4.3 x 14 x 0.4)	1	101	910-263-0	Sensor Cable Assembly (3F5)	1
29	194-902-3	Liner	1	69	976-794-0	Spring (3.8 x 33 x 0.4) WPC	2 ●	102	904-190-0	Extension Bar (1/2 x 60) (MC)	1
30	149-319-6	Anvil	1	70	977-160-0	Cone Spring (7.4 x 14 x 20)	1	103	953-205-0	Allen Head Flat Point Screw (M5 x 5)	1
31	194-440-3	Driving Blade	2	71	981-024-0	Polyurethane Ball (5 mm)	1	104	971-220-0	Pin (3 x 20)	1
32	194-904-3	Front Liner Plate	1	72	981-002-0	Ball (1/8)	1	105	990-016-0	O-Ring (P16)	1
33	194-905-3	Liner Casing	1	73	982-403-0	Ball Bearing (EE4)	1	107	004-790-2	Suspension Ring	1
34	194-906-3	Liner Casing Setter	1	74	982-950-0	Ball Bearing (16002)	1	108	939-105-0	Allen Wrench (4 mm)	1
35	850-429-1	Relief Valve Spindle	1	75	990-002-0	O-Ring (P4)	1				
38	194-742-3	Oil Plug	1								
39	149-754-6	Clip Ring	1								



**10000 SE PINE
PORTLAND, OR 97216
503-254-6600
FAX 503-255-2615**

When ordering spare parts, please specify tool type, part number, and description.

FOOTNOTES

● = Items in Pulse Repair Kit Alpha-110MC-PRK

ALPHA-110MC-PRK

(Kit contains following parts)

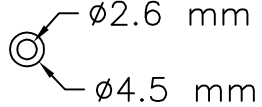
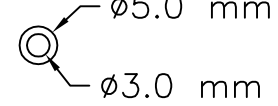
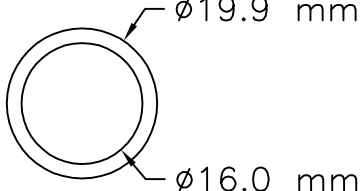
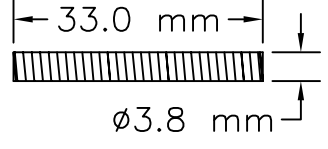
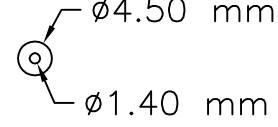
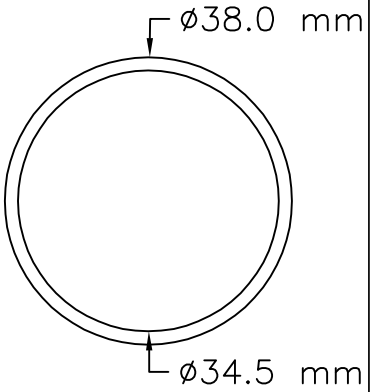
#/#	Bin Location	Part Number	QTY	Description	Material	Drawing / Scketch
1	PA10	944-002-0	2	Support Ring 2.6x4.5x1	Teflon-White	
2	PA10	944-003-0	1	Support Ring 3.0x5.0x1	Teflon-White	
3	PA10	944-210-0	1	Support Ring 16x19.9x1	Teflon-White	
4	PA1J	976-794-0	2	Spring 3.8x33.0	Spring wire ø.50 mm	
5	PA1A	990-320-0	1	O-Ring 4.5x1.4x1.6	Buna-Black	
6	PA1A	990-338-0	1	O-Ring (JW1530-28) 34.5x38x1.75	Buna-Black	

ALPHA-110MC-PRK

(Kit contains following parts)

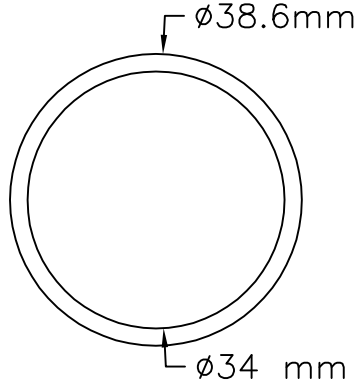
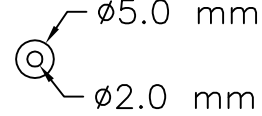
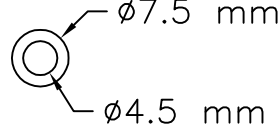
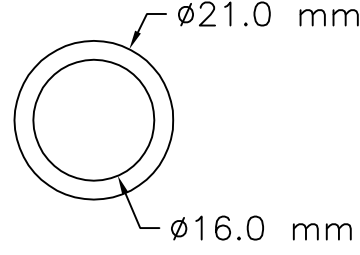
#/#	Bin Location	Part Number	QTY	Description	Material	Drawing / Scketch
7	PA1B	990-607-0	1	O-Ring 34x2.3 34x38.6x2.3	Buna-Black	 A technical drawing of a toroidal O-ring. It shows two concentric circles. The outer diameter is labeled as $\phi 38.6\text{mm}$ and the inner diameter is labeled as $\phi 34\text{ mm}$.
8	PA1B	990-900-0	2	O-Ring 5x2x1.5	Buna-Black	 A technical drawing of a small toroidal O-ring. It shows two concentric circles. The outer diameter is labeled as $\phi 5.0\text{ mm}$ and the inner diameter is labeled as $\phi 2.0\text{ mm}$.
9	PA1C	990-973-0	1	O-Ring (SNS-5) (NOK)	Buna-Black	 A technical drawing of a small toroidal O-ring. It shows two concentric circles. The outer diameter is labeled as $\phi 7.5\text{ mm}$ and the inner diameter is labeled as $\phi 4.5\text{ mm}$.
10	PA10	992-021-0	1	SU-Ring (Q-19) (NTN) 16x21x2.5	Buna-Black	 A technical drawing of a toroidal ring with a raised outer edge. It shows two concentric circles. The outer diameter is labeled as $\phi 21.0\text{ mm}$ and the inner diameter is labeled as $\phi 16.0\text{ mm}$.